

V311



Three-way Plug Valve, Flanged PN 16

V311 can be used in a wide range of applications, such as heating, cooling, air handling and domestic hot water systems. Soft EPDM seals provide tight shut off.

The valve can handle the following types of media:

- Hot and chilled water.
- Water with antifreeze additives such as glycol.

If the valve is used for media at temperatures below 0 °C (32 °F), it should be equipped with a stem or yoke heater in order to prevent ice formation on the valve stem.

SPECIFICATIONS

Designthree-way plug valve stem up closed
 (A port / B-AB open)
 Pressure class PN 16
 Flow characteristic A - AB EQM
 Flow characteristic B - AB Complementary
 Stroke 20 mm
 Rangeability $K_v/K_{v_{min}}$ >50
 Leakage A - AB and B - AB Tight sealing
 ΔP_m 400 kPa (58 psi), water
 Max. temperature of medium: 120 °C
 Min. temperature of medium: -20 °C
 Connection Flange according to ISO 7005-2

Materials

Body Nodular iron EN-JS 1030
 Stem Stainless steel SS 2346
 Plug Brass CW602N
 Plug Seal EPDM
 Seat Nodular iron EN-JS 1030
 Standard packing box Venta (EPDM)
 Pressure Equipment Directive PED 97/23/EC Cat. 0

Size		Kv m ³ /h	Part number
DN	in.		
15	½"	1.6	731-1117-000
15	½"	2.5	731-1121-000
15	½"	4.0	731-1125-000
20	¾"	6.3	731-1129-000
25	1"	10	731-1133-000
32	1¼"	16	731-1137-000
40	1½"	25	731-1141-000
50	2"	38	731-1145-000

Key to Technical specification

- The rangability is the ratio of K_v and $K_{v_{min}}$.
- K_v (C_v) is the flow through the valve in m³/h at the specified valve lift and at a pressure drop of 100 kPa across the valve.
- $K_{v_{min}}$ is the minimum controllable flow (m³/h) at a pressure drop of 100 kPa within the range in which the valve characteristics conform to the slope requirements of IEC 534-1.

DESIGN AND CHARACTERISTICS

The design of the V311 gives good resistance against solid particles in the fluid. The plug is guided throughout the lift, which reduces the risk of vibrations.

The V311 is designed to be used as a mixing valve.

The valve closes port A with the stem up.

The flow characteristics A -AB of the V311 is equal percentage modified.

The flow characteristics B - AB is complement to A - AB for constant sum of flow at $\beta = 0,5$.

DESIGN



CAVITATIONS

Cavitation takes place in a valve when the velocity of the flow between the plug and seat increases to the extent that gas bubbles are created in the water.

When, after the plug and seat, the velocity decreases, the gas bubbles collapse (implode), generating considerable noise and causing considerable wear on the valve.

By means of the cavitation diagram shown in the figure it can be checked if risk of cavitation exists with the working conditions in the pertinent installation.

Proceed as follows: Using the static pressure before the valve (e.g. 1000 kPa), plot the horizontal line to the line for the temperature of the liquid (e.g. 120 °C).

CHARACTERISTICS

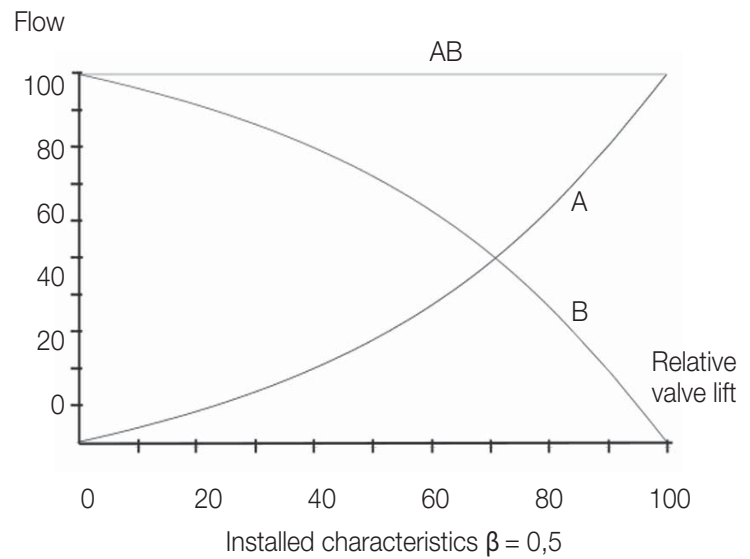

CAVITATIONS

Pressure drop chart at the beginning of cavitation

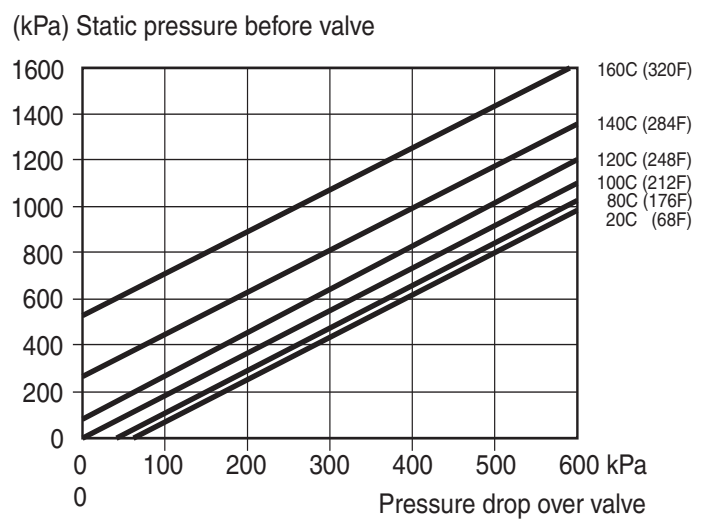

Pressure drop limit where cavitation might occur is dependent of valve inlet pressure and temperature of water.

From the intersection point, plot a vertical line downwards and read off the max. permissible pressure drop across the valve.

If the computed pressure drop exceeds the value read from the diagram there is risk for cavitation.

SPECIFICATION OF ACTUATOR

Use the diagram below to select actuator motor for the V311 to close required ΔP_c . A suitable actuator is selected, using the summary data sheet F-10-6.

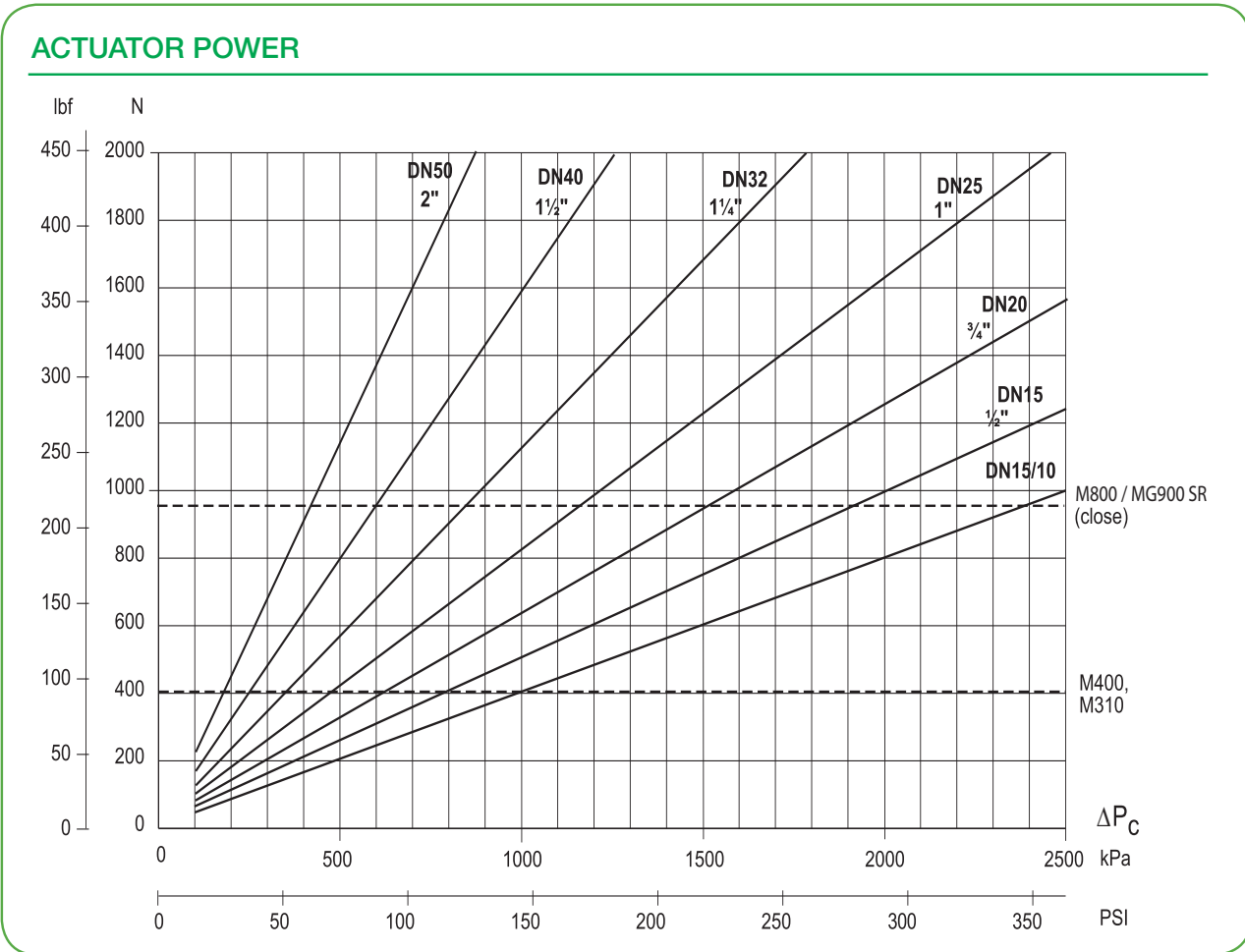

INSTALLATION

The valve should be mounted with flow direction in accordance with the valve marking.

It is recommended to install the valve in the return pipe, in order to avoid exposing the actuator to high temperatures.

The valve must not be installed with the actuator mounted below the valve.

To ensure that suspended solids will not become jammed between the valve plug and seat, a filter should be installed upstream of the valve, and the pipe system should be flushed before the valve is installed.

INSTALLATION

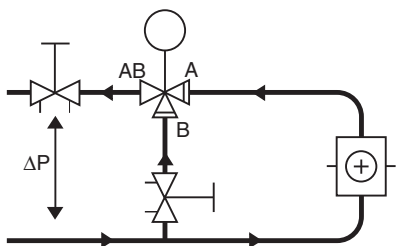

A. Circuit without local circulating pump.

To obtain good function the pressure drop across the valve should be no less than half of the available pressure drop (ΔP). This will give a valve authority of 50%.

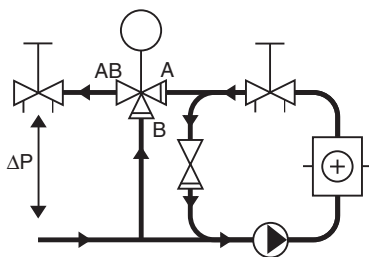

B. Circuit with local circulating pump.

The K_v value of the valve to be selected so that the entire available pressure drop, ΔP , falls across the control valve.

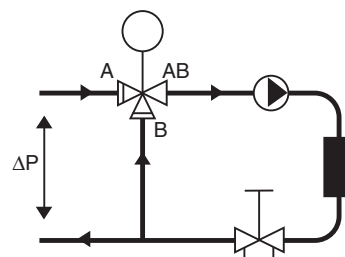

C. Circuit with local circulating pump.

The K_v value of the valve to be selected so that the pressure drop across the control valve becomes equal to or greater than ΔP .

PRESSURE DROP CHART

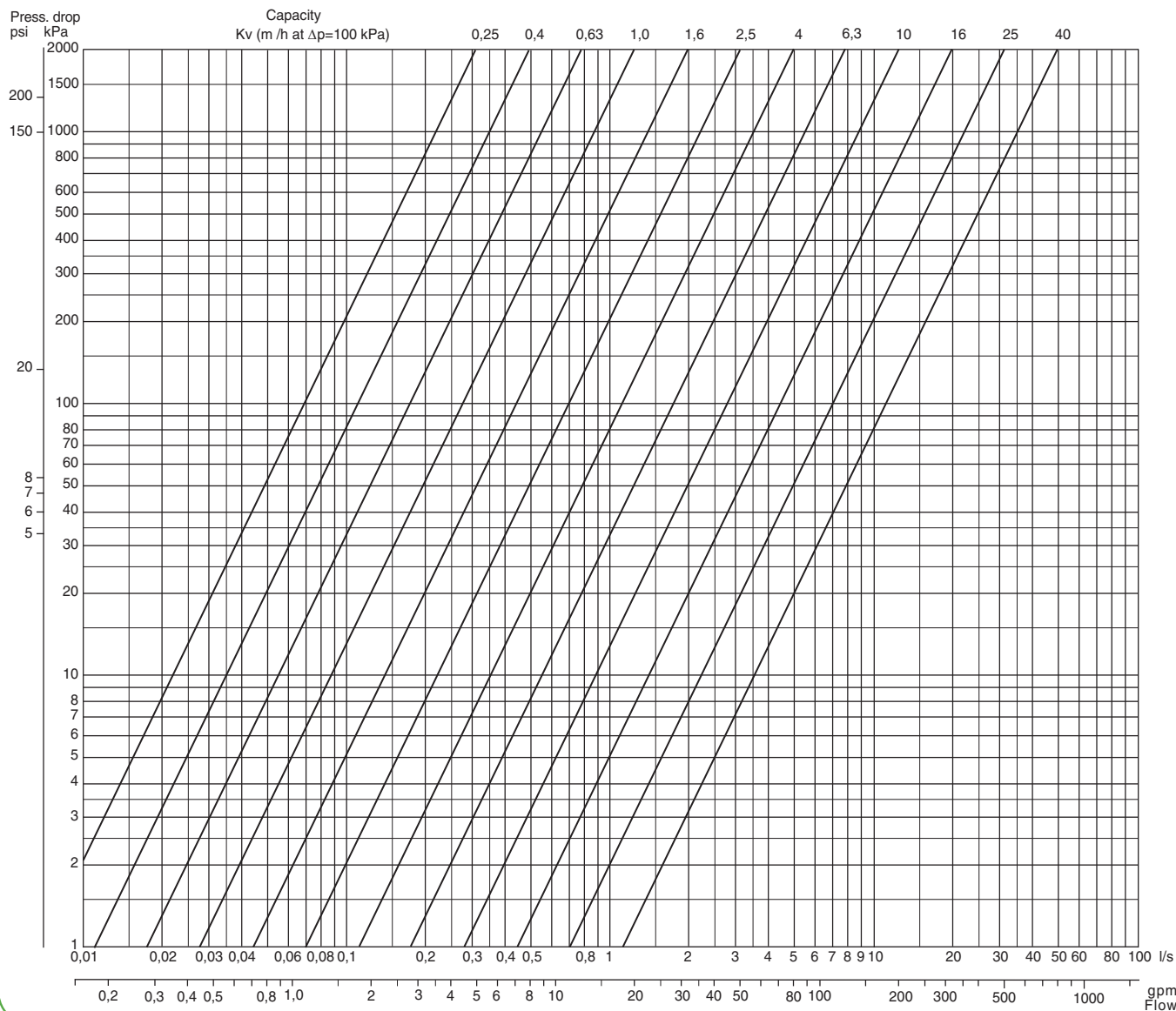

DIMENSIONS AND WEIGHT

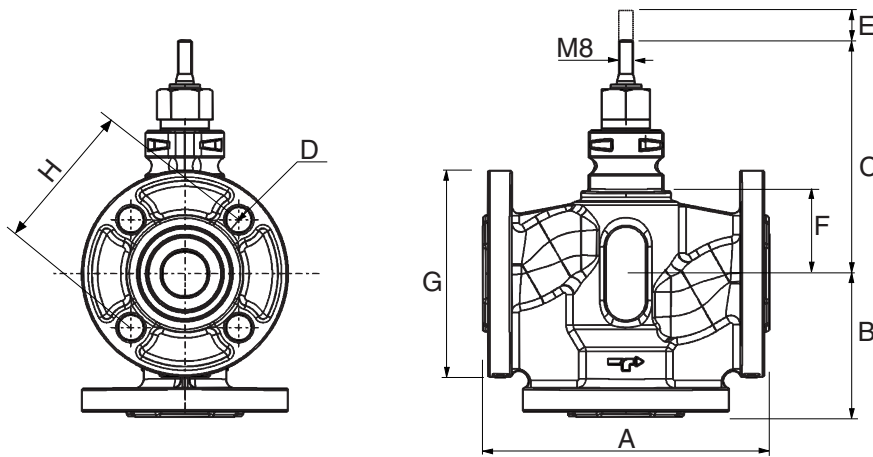

Part No 731-	Conn.		Dimensions								Weight kg
			A	B	C	D	E	F	G	H	
	DN	In.	mm	mm	mm	mm	mm	mm	mm	mm	
1117	15	½	130	65	123	4x14	20	38	95	65	2.5
1121	15	½	130	65	123	4x14	20	38	95	65	2.5
1125	15	½	130	65	123	4x14	20	38	95	65	2.5
1129	20	¾	150	75	126	4x14	20	41	105	75	3.2
1133	25	1	160	80	131	4x14	20	46	115	85	3.8
1137	32	1¼	180	90	144.5	4x19	20	59.5	140	100	6.6
1141	40	1½	200	100	146	4x19	20	61	150	110	7.5
1145	50	2	230	115	161	4x19	20	76	165	125	10.0

SPARE PARTS

Stuffing box

Standard type S max 150 °C (302 °F)

Item number 1-001-0800-0

On October 1st, 2009, TAC became the Buildings Business of its parent company Schneider Electric. This document reflects the visual identity of Schneider Electric, however there remains references to TAC as a corporate brand in the body copy. As each document is updated, the body copy will be changed to reflect appropriate corporate brand changes. All brand names, trademarks and registered trademarks are the property of their respective owners.