

V211T



Two-way Plug Valve, Internal pipe thread PN 16 (232 psi)

V211T can be used in a wide range of applications, such as heating, cooling, air handling and domestic hot water systems.

The valve can handle the following types of media:

- Hot and chilled water.
- Water with antifreeze additives such as glycol.

If the valve is used for media at temperatures below 0 °C (32 °F), it should be equipped with a stem heater in order to prevent ice formation on the valve stem.

SPECIFICATIONS

Design two-way plug valve
 Pressure class PN 16 (232 psi)
 Flow characteristic EQM
 Stroke 20 mm (0.79 in.)
 Rangeability K_v/K_{vmin} >50
 Leakage Tight sealing
 ΔP_m 400 kPa (58 psi), water
 Max. temperature of medium: 120 °C (248 °F)
 Min. temperature of medium: -20 °C (-4 °F)
 Connections Internal pipe thread Rp

Materials

Body Nodular iron EN-JS 1030
 Stem Stainless steel SS 2346
 Plug Brass CW602N
 Sealing EPDM
 Seat Nodular iron EN-JS 1030
 Standard packing box Venta
 Pressure Equipment Directive PED 97/23/EC Cat. 0

Size		Kv m ³ /h	Cv	Part number
DN	in.			
15	½"	1.6	1.9	721-1716-000
15	½"	2.5	2.9	721-1720-000
15	½"	4.0	4.7	721-1724-000
20	¾"	6.3	7.4	721-1728-000
25	1"	10	11.7	721-1732-000
32	1¼"	16	18.7	721-1736-000
40	1½"	25	29.3	721-1740-000
50	2"	38	44.5	721-1744-000

Key to Technical specification

- The rangeability is the ratio of K_v and $K_{v_{min}}$ (C_v and $C_{v_{min}}$).
- K_v (C_v) is the flow through the valve in m³/h at the specified valve lift and at a pressure drop of 100 kPa across the valve.
- $K_{v_{min}}$ ($C_{v_{min}}$) is the minimum controllable flow (m³/h) at a pressure drop of 100 kPa within the range in which the valve characteristics conform to the slope requirements of IEC 534-1.

DESIGN AND CHARACTERISTICS

The design of the V211T gives good resistance against solid particles in the fluid.

The plug is guided throughout the lift, which reduces the risk for vibrations. The valve closes with the stem up.

The flow characteristics of the V211T is equal percentage modified.

DESIGN



CAVITATIONS

Cavitation takes place in a valve when the velocity of the flow between the plug and seat increases to the extent that gas bubbles are created in the water.

When, after the plug and seat, the velocity decreases, the gas bubbles collapse (implode), generating considerable noise and causing considerable wear on the valve.

By means of the cavitation diagram shown in the figure it can be checked if risk of cavitation exists with the working conditions in the pertinent installation.

Proceed as follows: Using the static pressure before the valve (e.g. 1000 kPa), plot the horizontal line to the line for the temperature of the liquid (e.g. 120 °C).

From the intersection point, plot a vertical line downwards and read off the max. permissible pressure drop across the valve.

If the computed pressure drop exceeds the value read from the diagram there is risk for cavitation.

CHARACTERISTICS

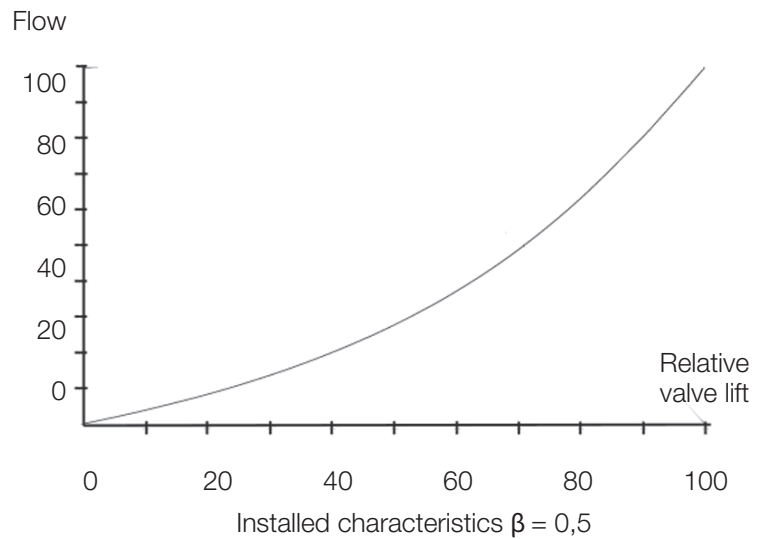

CAVITATIONS

Pressure drop chart at the beginning of cavitation

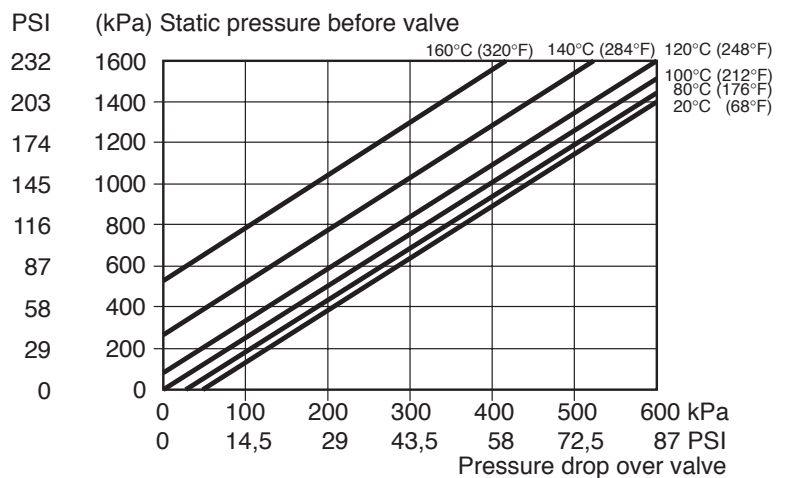

Pressure drop limit where cavitation might occur. Is dependent of valve inlet pressure and temperature of water.

SPECIFICATION OF ACTUATOR

Use the diagram below to select actuator motor for the V211T to close required ΔP_c .

A suitable actuator is selected, using the data sheet F-10-6.

ACTUATOR POWER

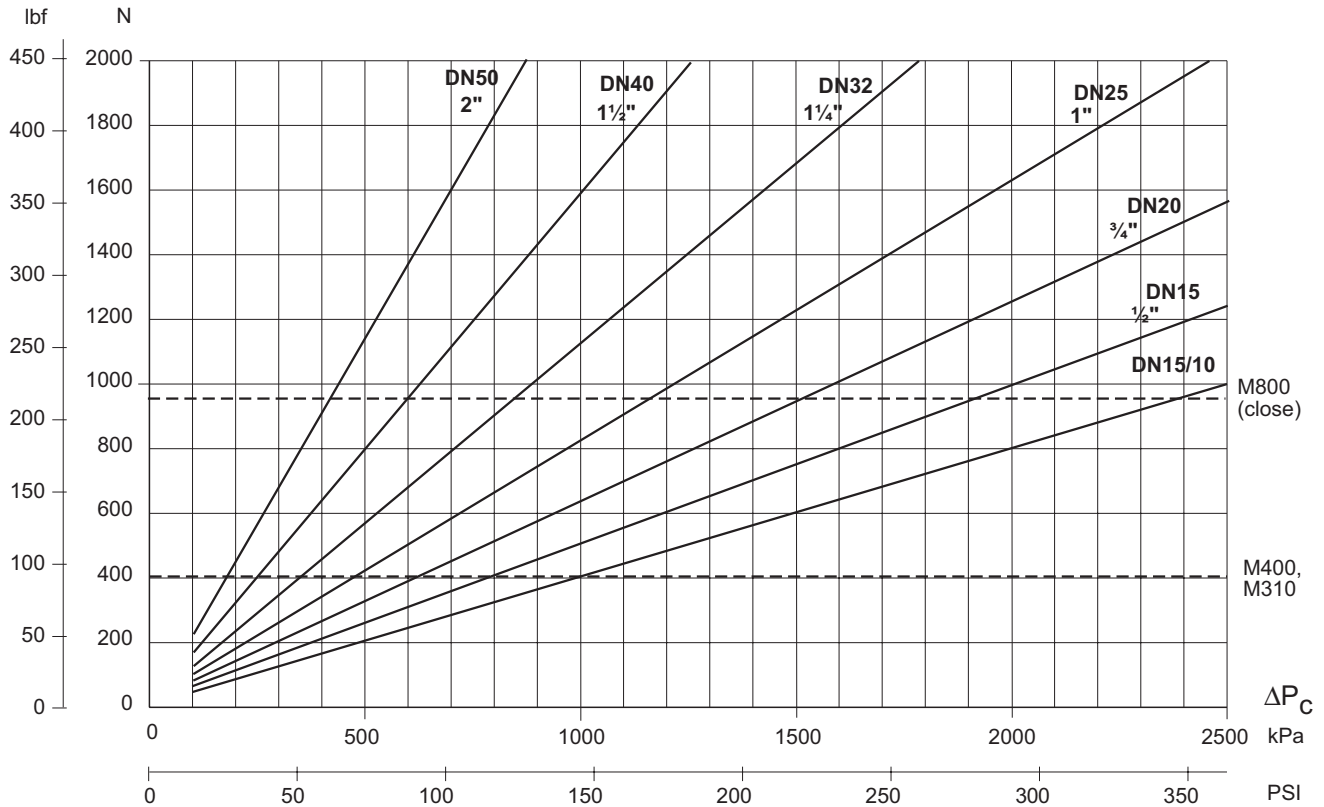

INSTALLATION

The valve should be mounted with flow direction in accordance with the valve marking.

It is recommended to install the valve in the return pipe, in order to avoid exposing the actuator to high temperatures.

The valve must not be installed with the actuator mounted below the valve.

To ensure that suspended solids will not become jammed between the valve plug and seat, a filter should be installed upstream of the valve, and the pipe system should be flushed before the valve is installed.

INSTALLATION

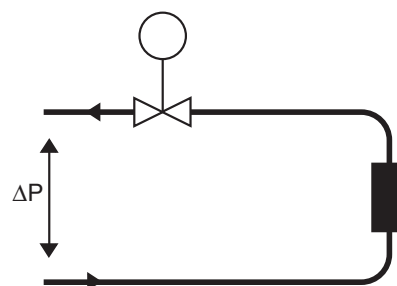

A. Typical installation without local circulating pump.

To provide a good function, the pressure drop across the valve should be no less than half of the available pressure (ΔP). This corresponds to a valve authority of 50%.

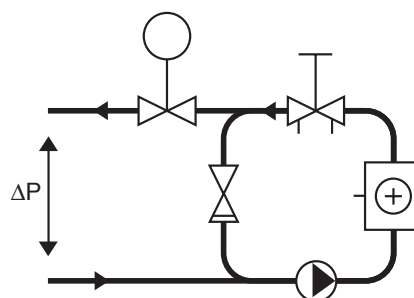

B. Typical installation with local circulating pump.

The K^V (C^V) value of the valve to be selected so that the entire available pressure drop (ΔP) falls across the control valve.

PRESSURE DROP CHART

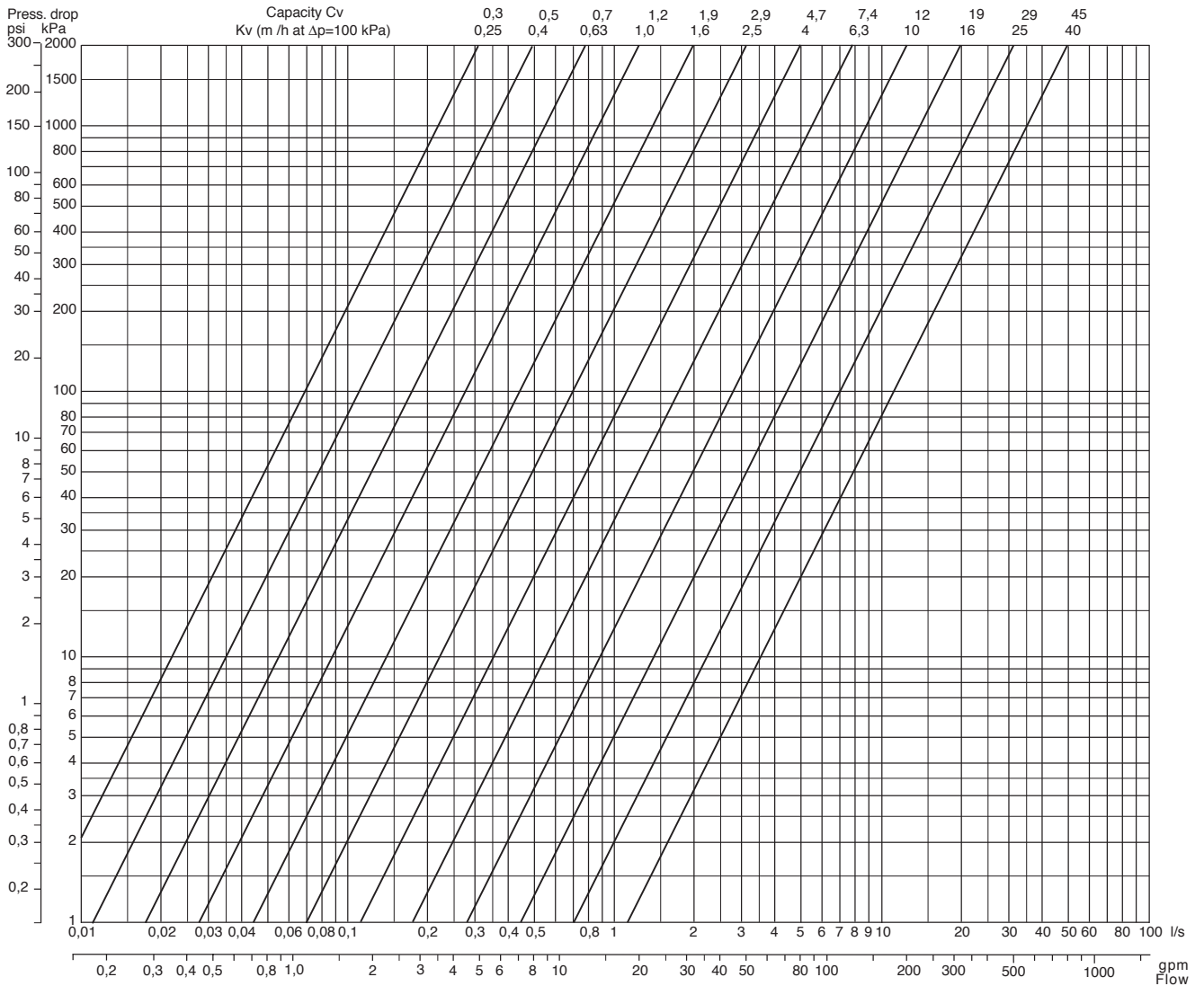

DIMENSIONS AND WEIGHT

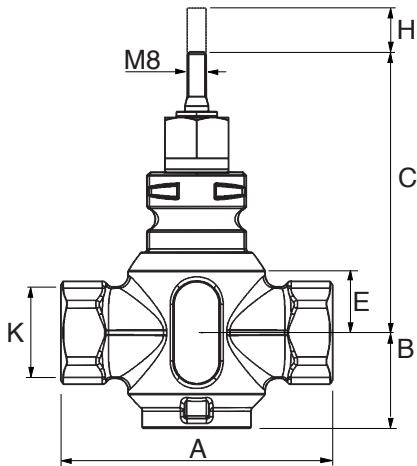

Part No 721-	Conn.		Dimensions												
			A		B		C		E		H		K	Weight	
	DN	In.	mm	In.	mm	In.	mm	In.	mm	In.	mm	In.	In.	kg	lb.
1716	15	½	85	3.35	38.5	1.52	108.5	4.27	23.5	0.93	20	0.79	Rp ½	1.0	2.2
1720	15	½	85	3.35	38.5	1.52	108.5	4.27	23.5	0.93	20	0.79	Rp ½	1.0	2.2
1724	15	½	85	3.35	38.5	1.52	108.5	4.27	23.5	0.93	20	0.79	Rp ½	1.1	2.26
1728	20	¾	100	3.94	40.5	1.59	115	4.53	30	1.18	20	0.79	Pr ¾	1.2	2.7
1732	25	1	115	4.53	40.5	1.59	119	4.69	34	1.34	20	0.79	Rp 1	1.3	2.9
1736	32	1¼	130	5.12	41	1.61	120	4.74	35	1.38	20	0.79	Rp 1¼	1.8	4.0
1740	40	1½	150	5.91	50	1.97	127.5	5.02	42.5	1.67	20	0.79	Rp 1½	2.7	6.0
1744	50	2	180	7.09	59	2.32	138	5.43	53	2.09	20	0.79	Rp 2	4.2	9.3

SPARE PARTS

Stuffing box

Standard type S max 150 °C (302 °F)
 Item number 1-001-0800-0

On October 1st, 2009, TAC became the Buildings Business of its parent company Schneider Electric. This document reflects the visual identity of Schneider Electric, however there remains references to TAC as a corporate brand in the body copy. As each document is updated, the body copy will be changed to reflect appropriate corporate brand changes. All brand names, trademarks and registered trademarks are the property of their respective owners.