

---

# LIOB-10x / x5x

L-IOB™ I/O Module

## User Manual

LOYTEC electronics GmbH



## Contact

LOYTEC electronics GmbH  
Blumengasse 35  
1170 Vienna  
AUSTRIA/EUROPE  
support@loytec.com  
<http://www.loytec.com>

Version 5.0

Document № 88078510

LOYTEC MAKES AND YOU RECEIVE NO WARRANTIES OR CONDITIONS, EXPRESS, IMPLIED, STATUTORY OR IN ANY COMMUNICATION WITH YOU, AND LOYTEC SPECIFICALLY DISCLAIMS ANY IMPLIED WARRANTY OF MERCHANTABILITY OR FITNESS FOR A PARTICULAR PURPOSE. THIS PRODUCT IS NOT DESIGNED OR INTENDED FOR USE IN EQUIPMENT INTENDED FOR SURGICAL IMPLANT INTO THE BODY OR OTHER APPLICATIONS INTENDED TO SUPPORT OR SUSTAIN LIFE, FOR USE IN FLIGHT CONTROL OR ENGINE CONTROL EQUIPMENT WITHIN AN AIRCRAFT, OR FOR ANY OTHER APPLICATION IN WHICH IN THE FAILURE OF SUCH PRODUCT COULD CREATE A SITUATION IN WHICH PERSONAL INJURY OR DEATH MAY OCCUR.

LOYTEC MAKES NO REPRESENTATION AND OFFERS NO WARRANTY OF ANY KIND REGARDING OF ANY THIRDPARTY COMPONENTS MENTIONED IN THIS MANUAL.

No part of this publication may be reproduced, stored in a retrieval system, or transmitted, in any form or by any means, electronic, mechanical, photocopying, recording, or otherwise, without the prior written permission of LOYTEC.

LC3020™, L-Chip™, L-Core™, L-DALI™, L-GATE™, L-INX™, L-IOB™, LIOB-Connect™, LIOB-FT™, L-IP™, LPA™, L-Proxy™, L-Switch™, L-Term™, L-VIS™, L-WEB™, L-ZIBI™ and ORION™ stack are trademarks of LOYTEC electronics GmbH.

LonTalk®, LONWORKS®, Neuron®, LONMARK®, LonMaker®, i.LON®, and LNS® are trademarks of Echelon Corporation registered in the United States and other countries.

## Contents

<b>1</b>	<b>Introduction .....</b>	<b>13</b>
1.1	Overview .....	13
1.2	Scope.....	14
<b>2</b>	<b>What's New .....</b>	<b>15</b>
2.1	New in LIOB-10x/x5x 5.0.0.....	15
<b>3</b>	<b>Quick-Start Guide .....</b>	<b>17</b>
3.1	<b>Quick-Start Guide (L-INX Mode) .....</b>	<b>17</b>
3.1.1	Hardware Installation .....	17
3.1.2	Configuration .....	17
3.2	<b>Quick-Start Guide (LONMARK® Mode) .....</b>	<b>19</b>
3.2.1	Hardware Installation .....	19
3.2.2	Commissioning .....	19
3.2.3	Configuration .....	19
3.3	<b>Quick-Start Guide (BACnet Mode) .....</b>	<b>20</b>
3.3.1	Hardware Installation .....	20
3.3.2	BACnet/IP Setup.....	21
3.3.3	Configuration .....	21
<b>4</b>	<b>Hardware Installation .....</b>	<b>22</b>
4.1	Enclosure.....	22
4.2	Product Label .....	22
4.3	Mounting.....	23
4.4	Terminal Layout.....	23
4.4.1	LIOB-100.....	24
4.4.2	LIOB-101.....	25
4.4.3	LIOB-102.....	26
4.4.4	LIOB-103.....	27
4.4.5	LIOB-150.....	28
4.4.6	LIOB-151.....	29
4.4.7	LIOB-152.....	30
4.4.8	LIOB-153.....	31
4.4.9	LIOB-154.....	32
4.4.10	LIOB-450/550.....	33
4.4.11	LIOB-451/551.....	34
4.4.12	LIOB-452/552.....	35
4.4.13	LIOB-453/553.....	36

4.4.14	LIOB-454/554 .....	37
4.4.15	LIOB-A2 .....	38
<b>4.5</b>	<b>Power Supply and Wiring.....</b>	<b>38</b>
4.5.1	LIOB-Connect without Extension .....	39
4.5.2	LIOB-Connect with Extension .....	40
4.5.3	LIOB-FT in Free Topology .....	40
4.5.4	LIOB-FT in Bus Topology .....	41
4.5.5	CEA-709 Network Connection in Free Topology or Bus Topology .....	42
4.5.6	LIOB-IP Connection .....	42
4.5.7	CEA-852 Network Connection.....	43
4.5.8	BACnet/IP Network Connection .....	43
<b>4.6</b>	<b>LED signals .....</b>	<b>43</b>
4.6.1	Status LED (L-INX Mode).....	43
4.6.2	Status LED (LONMARK® Mode) .....	44
4.6.3	Status LED (BACnet Mode).....	44
<b>4.7</b>	<b>Status Button.....</b>	<b>45</b>
<b>5</b>	<b>Device Modes and Installation .....</b>	<b>46</b>
<b>5.1</b>	<b>Device Modes .....</b>	<b>46</b>
5.1.1	LIOB-Connect Device Mode (LIOB-10x) .....	46
5.1.2	LIOB-FT Device Mode (LIOB-15x).....	46
5.1.3	LIOB-IP Device Mode (LIOB-45x/55x).....	46
5.1.4	LONMARK® Device Mode (LIOB-15x/45x).....	46
5.1.5	Non-ECS Device Mode (LIOB-15x/45x).....	46
5.1.6	BACnet Device Mode (LIOB-55x) .....	47
<b>5.2</b>	<b>Device Installation .....</b>	<b>47</b>
5.2.1	Device Installation (LIOB-Connect device mode) .....	47
5.2.2	Device Installation (LIOB-FT/IP device mode) .....	47
5.2.3	Device Installation (LONMARK® / Non-ECS device mode) .....	48
5.2.4	Device Installation (BACnet Mode).....	48
<b>5.3</b>	<b>Device Monitoring and Replacement .....</b>	<b>48</b>
5.3.1	Device Monitoring and Replacement (L-INX Mode).....	48
5.3.2	Device Monitoring and Replacement (LONMARK® Mode) .....	48
5.3.3	Device Replacement (BACnet Mode) .....	48
<b>6</b>	<b>L-IOB LCD Display .....</b>	<b>49</b>
<b>6.1</b>	<b>Main Page of LIOB-55x in BACnet Device Mode .....</b>	<b>49</b>
<b>6.2</b>	<b>Main Page of LIOB-10x/15x/45x (I/O Overview Page) .....</b>	<b>50</b>
<b>6.3</b>	<b>Manual / Quick Edit Mode .....</b>	<b>51</b>
<b>6.4</b>	<b>Device Information and Configuration (LIOB-10x/15x/45x).....</b>	<b>51</b>
<b>6.5</b>	<b>I/O Configuration .....</b>	<b>54</b>

<b>7</b>	<b>L-IOB Web Interface (LIOB-45x/55x)</b>	<b>55</b>
7.1	Device Information and Account Management	55
7.2	Device Configuration	57
7.2.1	System Configuration	57
7.2.2	Backup and Restore	58
7.2.3	Port Configuration	59
7.2.4	IP Configuration	60
7.2.5	Ethernet Switch	60
7.2.6	VNC Configuration	61
7.2.7	LIOB-IP Configuration (LIOB-IP Device Mode)	61
7.2.8	CEA-852 Device Configuration (LONMARK® Mode)	62
7.2.9	BACnet Configuration (BACnet Mode)	63
7.2.10	BACnet/IP Configuration (BACnet Mode)	64
7.2.11	Data Points and AST (BACnet Mode)	64
7.2.12	Firmware	65
7.3	Device Statistics	65
7.3.1	System Log	65
7.3.2	IP Statistics	66
7.3.3	CEA-852 Statistics (LIOB-IP or LONMARK® Mode)	66
7.3.4	Enhanced Communications Test (LIOB-IP or LONMARK® Mode)	67
7.3.5	CEA-709 Statistics (LIOB-IP or LONMARK® Mode)	68
7.3.6	BACnet Bindings Statistics (BACnet Mode)	68
7.3.7	Scheduler and Alarm Log Statistics (BACnet Mode)	69
7.4	L-IOB Page (L-INX Mode)	69
7.5	Reset, Contact, Logout	69
<b>8</b>	<b>L-IOB Host LCD Display (L-INX Mode)</b>	<b>70</b>
8.1	L-IOB Scan and Configuration Run	70
8.2	L-IOB Remote Access	70
8.3	L-IOB Data Points	71
<b>9</b>	<b>L-IOB Host Web Interface (L-INX Mode)</b>	<b>72</b>
9.1	LIOB-IP Bus (for LIOB-45x/55x)	72
9.2	L-IOB Installation Page (LIOB-Connect Bus)	73
9.2.1	L-IOB Scan and Configuration Run	73
9.3	L-IOB Installation Page (LIOB-FT/IP Bus)	75
9.4	L-IOB Device Information and Statistics	76
9.5	L-IOB Overview Page	76
9.6	L-IOB I/O Test Page	78
9.7	L-IOB Data Points	79
<b>10</b>	<b>Concepts</b>	<b>80</b>

<b>10.1</b>	<b>Technology-Independent Data Points (BACnet Mode)</b> .....	<b>80</b>
<b>10.2</b>	<b>Bus and Device Configuration</b> .....	<b>80</b>
10.2.1	Index of first Device not in Daisy Chain (LIOB-Connect device mode).	80
10.2.2	Station ID (L-INX Mode).....	80
10.2.3	Minimum Firmware Version (L-INX Mode).....	80
10.2.4	Enabled (L-INX Mode).....	81
10.2.5	Product Code.....	81
10.2.6	Device Name.....	81
10.2.7	PIN.....	81
10.2.8	Alternative Unit.....	81
10.2.9	Language.....	81
10.2.10	Group I/O Min/Max Send Times (LONMARK® Mode).....	81
10.2.11	NID.....	81
10.2.12	Translation Tables.....	81
<b>10.3</b>	<b>I/O Configuration</b> .....	<b>81</b>
10.3.1	Name.....	81
10.3.2	HardwareType.....	82
10.3.3	SignalType.....	82
10.3.4	Interpretation.....	82
10.3.5	DataType.....	85
10.3.6	SNVT.....	85
10.3.7	DeadTime for Fading and Ramping.....	85
10.3.8	IOFunc, GroupNumber, and DeadTime for Interlocked Mode.....	85
10.3.9	IOFunc, GroupNumber, and SubGroupNumber for Switch Mode.....	86
10.3.10	IOFunc, GroupNumber, and SubGroupNumber for Card Reader Mode.....	86
10.3.11	OperatingMode, OverrideValue, and DefaultValue.....	86
10.3.12	Persistent Flag.....	87
10.3.13	Invert Flag.....	87
10.3.14	AnaInvert Flag.....	87
10.3.15	Sqrt Flag.....	87
10.3.16	NoValCorr Flag.....	88
10.3.17	PulseTime Flag.....	88
10.3.18	SIUnit_OnText and USUnit_OffText.....	88
10.3.19	Resolution.....	88
10.3.20	MultUS and OffsUS.....	88
10.3.21	DisplayOnSymbol and DisplayOffSymbol.....	88
10.3.22	Offset.....	89
10.3.23	MinValue and MaxValue.....	89
10.3.24	COV and MaxSendTime.....	89

10.3.25	MinSendTime .....	89
10.3.26	TransTable .....	89
10.3.27	NTC_Rn, NTC_Tn, and NTC_B .....	90
10.3.28	HoldTime and DebounceTime .....	90
10.3.29	EventGroup Modes and Values .....	90
10.3.30	OffValue and OnValue .....	90
10.3.31	PWMPeriod .....	91
10.3.32	NominalPower .....	91
<b>10.4</b>	<b>Switch Mode (LONMARK® Mode).....</b>	<b>91</b>
10.4.1	General Function.....	91
10.4.2	Two-Input Mode .....	94
10.4.3	Examples.....	94
<b>10.5</b>	<b>STId Card Reader Mode .....</b>	<b>99</b>
10.5.1	Code Signal.....	99
10.5.2	Data Signal.....	99
10.5.3	Clock Signal.....	99
<b>10.6</b>	<b>Data Points (L-INX Mode) .....</b>	<b>100</b>
10.6.1	Bus specific Data Points .....	100
10.6.2	Device specific Data Points .....	100
10.6.3	I/O specific Data Points for Inputs .....	101
10.6.4	I/O specific Data Points for Outputs .....	102
10.6.5	Parameters.....	103
<b>10.7</b>	<b>Data Points (LONMARK® Mode) .....</b>	<b>104</b>
10.7.1	Device Global Configuration Properties .....	104
10.7.2	Node Object (UFPTnodeObject, FPT Key #0).....	104
10.7.3	Common Terminal Object (UFPTcomTerm, FPT Key #20013) .....	106
10.7.4	Input / Output / Group Mapping .....	106
10.7.5	Input Object (UFPTopenLoopSensor, FPT Key #1).....	109
10.7.6	Output Object (UFPTclosedLoopActuator, FPT Key #4) .....	112
<b>10.8</b>	<b>Data Points (BACnet Mode).....</b>	<b>115</b>
10.8.1	BACnet Technology .....	115
10.8.2	Native BACnet Objects for I/Os .....	115
<b>10.9</b>	<b>Default Configuration.....</b>	<b>118</b>
<b>11</b>	<b>The Configurator.....</b>	<b>119</b>
<b>11.1</b>	<b>Software Installation and General Settings .....</b>	<b>119</b>
<b>11.2</b>	<b>Configuring L-IOB Modules (L-INX Mode) .....</b>	<b>119</b>
11.2.1	Add L-IOB Modules .....	120
11.2.2	Configure I/Os .....	121
11.2.3	Manage L-IOB Configurations .....	122

11.2.4 Using L-IOB Data Points .....	124
11.2.5 Upgrade Firmware.....	125
11.2.6 Printing Labels .....	126
<b>11.3 Configuring L-IOB Modules (LONMARK® / Non-ECS device mode).....</b>	<b>127</b>
11.3.1 Connecting to a L-IOB Module.....	127
11.3.2 L-IOB Device Settings .....	129
11.3.3 Configure I/Os .....	130
11.3.4 Manage L-IOB Configurations.....	130
11.3.5 Up- and Download of Configurations.....	131
11.3.6 Using L-IOB Data Points .....	131
11.3.7 Upgrade Firmware.....	131
11.3.8 Backup and Restore.....	132
11.3.9 Printing Labels .....	132
<b>11.4 Configuring L-IOB Modules (BACnet Mode) .....</b>	<b>132</b>
11.4.1 Connecting to a L-IOB Module.....	132
11.4.2 Configure I/Os.....	133
11.4.3 Manage L-IOB Configurations.....	134
11.4.4 Up- and Download of Configurations.....	135
11.4.5 Using L-IOB Data Points .....	135
11.4.6 Upgrade Firmware.....	137
11.4.7 Backup and Restore.....	137
11.4.8 Printing Labels .....	137
<b>12 L-IOB Firmware Update .....</b>	<b>138</b>
12.1 Firmware Update using the Configurator .....	138
12.2 Firmware Update using LWEB-900.....	138
12.3 Firmware Update via the Web Interface (LIOB-45x/55x) .....	138
<b>13 L-IOB Device Replacement .....</b>	<b>139</b>
13.1 L-IOB Device Replacement (L-INX Mode) .....	139
13.1.1 LIOB-Connect Device Replacement with L-INX Power-Cycle .....	139
13.1.2 LIOB-Connect Device Replacement without L-INX Power-Cycle .....	139
13.1.3 LIOB-FT/IP Device Replacement .....	140
13.2 L-IOB Device Replacement (LONMARK® Mode) .....	140
13.3 L-IOB Device Replacement (BACnet Mode).....	140
<b>14 Troubleshooting.....</b>	<b>141</b>
14.1 Technical Support.....	141
<b>15 Application Notes .....</b>	<b>142</b>
15.1 External Power Supply (not using LPOW-2415A) .....	142
15.2 Physical Connection of Inputs .....	142
15.2.1 Connection of Switches .....	142



15.2.2	Connection of S0 Pulse Devices (Meters).....	143
15.2.3	Connection of Voltage Sources to Universal Inputs .....	144
15.2.4	Connection of 4-20mA Transmitters to Universal Inputs .....	144
15.2.5	Connection of Resistive Sensors .....	145
15.2.6	Connection of STId Card Readers .....	145
<b>15.3</b>	<b>Physical Connection of Outputs.....</b>	<b>146</b>
15.3.1	6A Relays on LIOB-100 (Built-in Fuse).....	146
15.3.2	6A Relays with One External Fuse .....	146
15.3.3	6A Relays on LIOB-xx2 using Separate Fuses .....	147
15.3.4	16A and 6A Relays on LIOB-xx3.....	147
15.3.5	External Relays and Inductive Loads.....	148
15.3.6	1A Triacs .....	148
15.3.7	Analog Outputs .....	149
<b>15.4</b>	<b>Redundant Ethernet (LIOB-45x/55x).....</b>	<b>149</b>
15.4.1	Ethernet Cabling Options.....	149
15.4.2	Upstream Options .....	151
15.4.3	Preconditions .....	151
15.4.4	Switch Settings.....	152
15.4.5	Testing .....	152
15.4.6	Example switch configuration.....	153
<b>16</b>	<b>Security Hardening Guide.....</b>	<b>154</b>
<b>16.1</b>	<b>Installation Instructions.....</b>	<b>154</b>
<b>16.2</b>	<b>Firmware.....</b>	<b>154</b>
<b>16.3</b>	<b>Ports .....</b>	<b>154</b>
<b>16.4</b>	<b>Services.....</b>	<b>155</b>
<b>16.5</b>	<b>Logging and Auditing .....</b>	<b>155</b>
<b>17</b>	<b>Specifications .....</b>	<b>156</b>
<b>17.1</b>	<b>I/O Specification .....</b>	<b>156</b>
17.1.1	UI - Universal Input .....	156
17.1.2	DI - Digital Input, Counter Input (S0-Pulse).....	156
17.1.3	AO - Analog Output.....	157
17.1.4	DO - Digital Output .....	157
17.1.5	PRESS - Pressure Sensor .....	157
<b>17.2</b>	<b>Internal Translation Tables.....</b>	<b>157</b>
<b>17.3</b>	<b>Maximum Number of L-IOB Devices per L-IOB Host.....</b>	<b>158</b>
<b>17.4</b>	<b>Specification for LIOB-10x Models .....</b>	<b>159</b>
<b>17.5</b>	<b>Specification for LIOB-15x Models .....</b>	<b>160</b>
<b>17.6</b>	<b>Specification for LIOB-45x Models .....</b>	<b>161</b>
<b>17.7</b>	<b>Specification for LIOB-55x Models .....</b>	<b>162</b>

**18 References ..... 163**  
**19 Revision History ..... 164**

## Abbreviations

AST .....	Alarming, Scheduling, Trending
BACnet .....	Building Automation and Control Network
CEA-709 .....	Protocol standard for LONWORKS networks
CEA-852 .....	Protocol standard for CEA-709 over IP networks
COV .....	Change-Of-Value
CP.....	Configuration Property
CS.....	Configuration Server that manages CEA-852 IP devices
DHCP.....	Dynamic Host Configuration Protocol, RFC 2131, RFC 2132
I/O .....	Input/Output
LIOB .....	LOYTEC I/O bus
MAC .....	Media Access Control
NAT .....	Network Address Translation, see Internet RFC 1631
NTC .....	Negative Temperature Coefficient (Temperature Sensor)
NV.....	Network Variable
OPC.....	Open Process Control
PTC.....	Positive Temperature Coefficient (Temperature Sensor)
SCPT.....	Standard Configuration Property Type
SNVT .....	Standard Network Variable Type
UCPT .....	User-Defined Configuration Property Type
UI.....	User Interface

Additionally, the following abbreviations are used for the L-IOB device modes:

<b>L-INX Mode</b> .....	Refers to the LIOB-Connect device mode (LIOB-10x models), the LIOB-FT device mode (LIOB-15x models), and the LIOB-IP device mode (LIOB-45x/55x models). A L-IOB host is needed (e.g. L-INX device).
<b>LONMARK® Mode</b> .....	Refers to the LONMARK® and non-ECS device modes (LIOB-15x/45x models). In these modes, the LIOB-15x/45x devices act as independent nodes on a CEA-709 network. A L-IOB host is not needed.
<b>BACnet Mode</b> .....	Refers to the BACnet device mode of the LIOB-55x models. In this mode, the LIOB-55x devices act as independent nodes on a BACnet/IP network. A L-IOB host is not needed.



# 1 Introduction

## 1.1 Overview

The L-IOB I/O modules LIOB-10x, LIOB-15x, LIOB-45x, and LIOB-55x provide physical inputs and outputs (I/Os) either through a CEA-709 connection, a BACnet/IP connection, or a direct connection to a L-IOB host (e.g. L-INX automation server). The I/Os can e.g. be used as data points in the IEC 61131 program running on the L-IOB host. The L-IOB I/O modules come in different models with different I/O configurations, including analog outputs, digital outputs, digital inputs, and universal inputs, which can be freely configured.

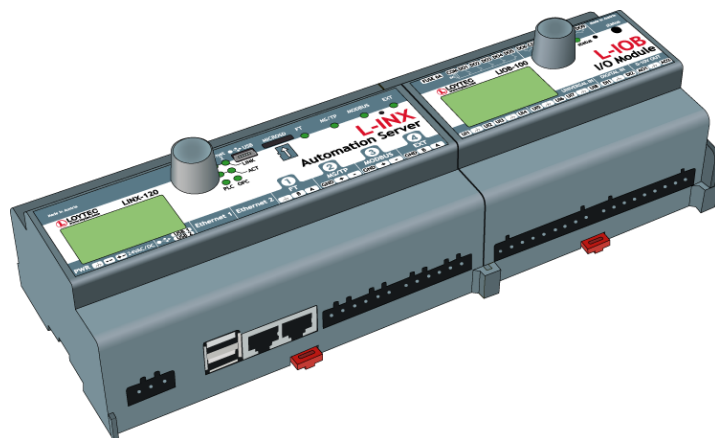

Figure 1: L-IOB installation with L-INX device

The LIOB-10x modules are added to the L-INX automation server using the LIOB-Connect system. An example is shown in Figure 1. To add a L-IOB module to the L-INX device, slide the module from the top to the bottom. The plastic fitting on the side holds the module in place and the gold contacts attach the L-IOB module to the LIOB-Connect bus. The L-IOB modules are powered through the LIOB-Connect bus. Depending on the L-INX device, up to 8 or even 24 L-IOB devices can be stacked up this way in a daisy chain.

The LIOB-15x modules are either connected over the LIOB-FT port of a L-INX device or over any CEA-709 FT network (LONMARK® / Non-ECS device modes). This allows connecting remote I/Os over standard FT cabling.

The LIOB-45x modules are either connected via the LIOB-IP protocol of a L-INX or LIOB-48x/58x device, or over any CEA-852 network (LONMARK® / Non-ECS device modes). In both cases, the physical connection is done via Ethernet/IP. Some models feature a 2-port Ethernet switch.

The LIOB-55x modules are either connected via the LIOB-IP protocol of a L-INX or LIOB-48x/58x device, or over any BACnet/IP network (BACnet device mode). In both cases, the physical connection is done via Ethernet/IP. Some models feature a 2-port Ethernet switch. All LIOB-55x models are BTL-certified B-BC devices.

Whenever a L-INX (or LIOB-48x/58x) device is needed as a L-IOB host, the L-IOB device mode is abbreviated as '**L-INX Mode**'. This covers the LIOB-Connect device mode (LIOB-10x models), the LIOB-FT device mode (LIOB-15x models), and the LIOB-IP device mode (LIOB-45x/55x models). Whenever the L-IOB devices act as independent nodes on a CEA-709 network without the need for a L-IOB host, the L-IOB device mode is abbreviated as '**LONMARK® Mode**'. This covers the LONMARK® and non-ECS device modes (LIOB-15x/45x models). Whenever the L-IOB devices act as independent nodes on a BACnet network without the need for a L-IOB host, the L-IOB device mode is abbreviated as '**BACnet Mode**'. These three abbreviations ('L-INX Mode', 'LONMARK® Mode', and 'BACnet Mode') will be used throughout this entire document, especially in headings, to point out that the following section only applies to this mode. Refer to Section 5.1 for more information about the different L-IOB device modes and Section 6.4 for information on how to setup the device mode in LIOB-15x/45x/55x models.

Initial configuration of the L-IOB modules is accomplished through the L-INX Configurator software. The parameterization of I/Os, self-test, manual modes, override values, etc. can also be operated on the L-IOB's LCD display, the Web UI of a connected L-IOB host, or the LWEB-900 tool.

---

## 1.2 Scope

This document covers LIOB-10x, LIOB-15x, LIOB-45x, and LIOB-55x modules with firmware version 5.0 (or higher), the L-INX automation server firmware version 5.0 (or higher) and the L-INX Configurator version 5.0 (or higher).

# 2 What's New

---

## 2.1 New in LIOB-10x/x5x 5.0.0

This section describes the major changes and new features in version 5.0.0. For a full list of changes refer to the Readme file.

### **New L-IOB Models**

The new models LIOB-454 and LIOB-554 with a 2-port Ethernet switch and a built-in pressure sensor are supported by the firmware. See Sections 4.4.14, 17.6, and 17.7.

### **2-Port Ethernet Switch Support**

The new firmware supports all models with a built-in 2-port Ethernet switch. See Sections 7.2.5 and 15.4.

### **Duration Mode of Digital Outputs**

Digital outputs can be configured in a “Duration” mode. In this mode, the value written to the output is interpreted as a time period, the output shall stay active. When the period ends, the output is automatically switched inactive again. See Section 10.3.5.

### **Support of State-controlled Occupancy Sensors**

The L-IOB now also supports occupancy sensors, which do not generate pulses but rather are only switched to the active state as long as occupancy is detected. See Section 10.3.28.

### **Simplified Offset Calibration in the LCD UI**

The calibrated life value is now shown next to the offset value for simplified calibration in the LCD UI. See Section 10.3.22.

### **Switching Off Detection of Disconnected Sensors**

A new flag is introduced, which allows switching off the detection of disconnected sensors so that every measured value is processed. See Section 10.3.16.

### **Firmware upgrade via Web Interface**

A new firmware upgrade menu on the Web interface allows online checking for firmware updates and upgrading by selecting a local firmware file. All this is possible without starting the Configurator.

**BACnet**

All LIOB-55x models are now BTL-certified as B-BC devices.



# 3 Quick-Start Guide

This chapter shows step-by-step instructions on how to configure the L-IOB I/O module for a simple application.

## 3.1 Quick-Start Guide (L-INX Mode)

Observe that this quick-start guide only covers the LIOB-Connect (LIOB-10x), LIOB-FT (LIOB-15x), and LIOB-IP (LIOB-45x/55x) device modes, see Section 5.1. For this guide, it is assumed that the L-IOB host is a L-INX automation server.

### 3.1.1 Hardware Installation

Depending on the L-IOB model, the L-IOB I/O modules can either be attached directly to the LIOB-Connect bus, the LIOB-FT bus of the L-INX device, or Ethernet/IP.

For LIOB-10x devices (LIOB-Connect), connect the first L-IOB device to the L-INX by sliding it from top to bottom at the right side of the L-INX (see Figure 1). The plastic fitting on the side holds the module in place and the gold contacts attach the L-IOB module to the LIOB-Connect bus. Connect further L-IOB devices the same way to the last L-IOB device already connected.

### 3.1.2 Configuration

Configuration of the L-IOB devices is achieved using the L-INX Configurator software, see the corresponding user manual [1]. The L-INX Configurator uses a separate tab to configure the L-IOB devices. The L-IOB device configuration can be done offline and is shown in the following steps.

#### To Configure L-IOB I/Os

1. Add L-IOB devices on the **L-IOB** tab from the supplied L-IOB templates using the **Add Device(s)** button  as shown in Figure 2.

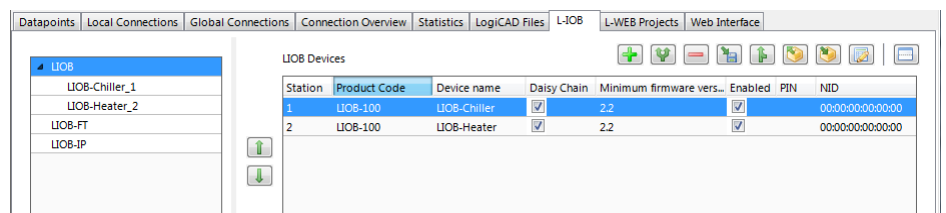
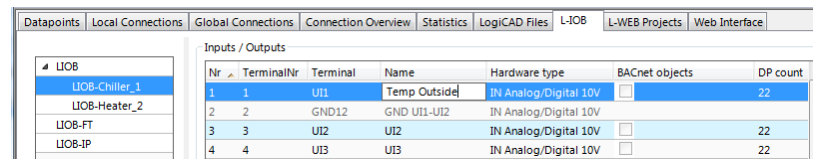

Figure 2: Add L-IOB devices to the LIOB-Connect bus

2. Select a L-IOB device in the tree on the left-hand side and enter names for the I/Os by double-clicking into the **Name** column as shown in Figure 3.



Nr.	TerminalNr	Terminal	Name	Hardware type	BACnet objects	DP count
1	1	UI1	Temp Outside	IN Analog/Digital 10V	<input type="checkbox"/>	22
2	2	GND12	GND UI1-UI2	IN Analog/Digital 10V	<input type="checkbox"/>	
3	3	UI2	UI2	IN Analog/Digital 10V	<input type="checkbox"/>	22
4	4	UI3	UI3	IN Analog/Digital 10V	<input type="checkbox"/>	22

Figure 3: Change I/O names

3. Select an I/O and change the object parameters to configure this I/O. You can multi-select I/Os and change the parameters for all selected I/Os, see Figure 4.

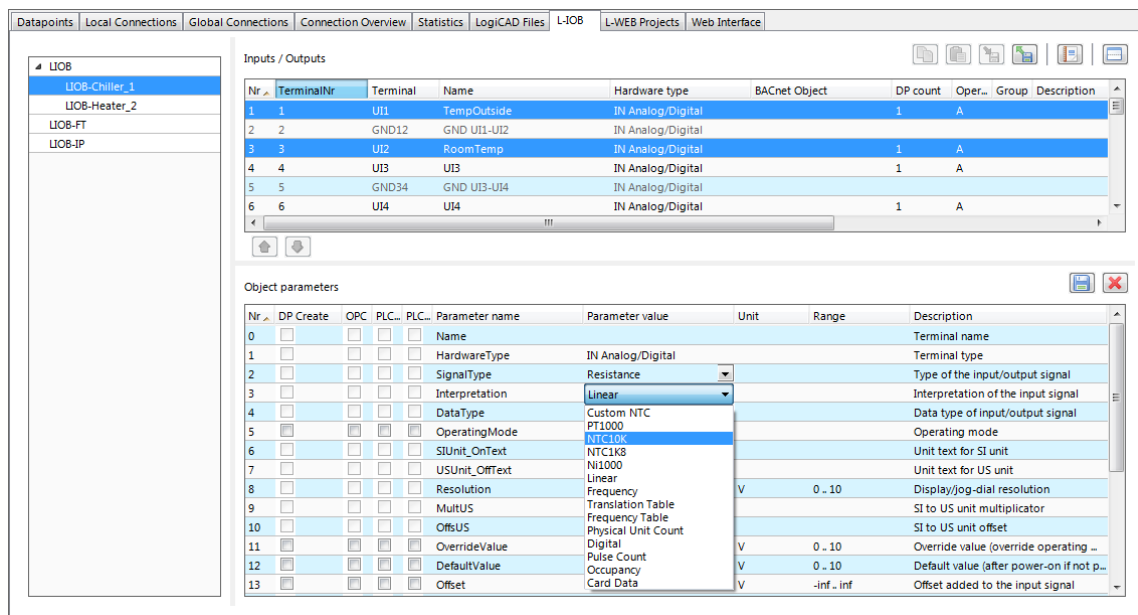

Nr.	DP Create	OPC	PLC...	PLC...	Parameter name	Parameter value	Unit	Range	Description
0	<input type="checkbox"/>	<input type="checkbox"/>	<input type="checkbox"/>	<input type="checkbox"/>	Name				Terminal name
1	<input type="checkbox"/>	<input type="checkbox"/>	<input type="checkbox"/>	<input type="checkbox"/>	HardwareType	IN Analog/Digital			Terminal type
2	<input type="checkbox"/>	<input type="checkbox"/>	<input type="checkbox"/>	<input type="checkbox"/>	SignalType	Resistance			Type of the input/output signal
3	<input type="checkbox"/>	<input type="checkbox"/>	<input type="checkbox"/>	<input type="checkbox"/>	Interpretation	Linear			Interpretation of the input signal
4	<input type="checkbox"/>	<input type="checkbox"/>	<input type="checkbox"/>	<input type="checkbox"/>	DataType	Custom NTC			Data type of input/output signal
5	<input type="checkbox"/>	<input type="checkbox"/>	<input type="checkbox"/>	<input type="checkbox"/>	OperatingMode	PT1000			Operating mode
6	<input type="checkbox"/>	<input type="checkbox"/>	<input type="checkbox"/>	<input type="checkbox"/>	SIUnit_OnText	NTC1K8			Unit text for SI unit
7	<input type="checkbox"/>	<input type="checkbox"/>	<input type="checkbox"/>	<input type="checkbox"/>	USUnit_OffText	Ni1000			Unit text for US unit
8	<input type="checkbox"/>	<input type="checkbox"/>	<input type="checkbox"/>	<input type="checkbox"/>	Resolution	Frequency	V	0..10	Display/jog-dial resolution
9	<input type="checkbox"/>	<input type="checkbox"/>	<input type="checkbox"/>	<input type="checkbox"/>	MultUS	Translation Table			SI to US unit multiplier
10	<input type="checkbox"/>	<input type="checkbox"/>	<input type="checkbox"/>	<input type="checkbox"/>	OffUS	Frequency Table			SI to US unit offset
11	<input type="checkbox"/>	<input type="checkbox"/>	<input type="checkbox"/>	<input type="checkbox"/>	OverrideValue	Physical Unit Count	V	0..10	Override value (override operating ...
12	<input type="checkbox"/>	<input type="checkbox"/>	<input type="checkbox"/>	<input type="checkbox"/>	DefaultValue	Digital	V	0..10	Default value (after power-on if not p...
13	<input type="checkbox"/>	<input type="checkbox"/>	<input type="checkbox"/>	<input type="checkbox"/>	Offset	Pulse Count	V	-inf..inf	Offset added to the input signal

Figure 4: Change L-IOB parameters for the selected I/O(s)

4. On the **Datapoints** tab, the L-IOB data points have been created. These data points can be used, e.g., in the logiCAD IEC61131 program. For physical inputs, the data point **Lx\_y\_zzz\_Input** will be used to read the input value and for physical outputs, the data point **Lx\_y\_zzz\_Output** will be used to set the output value.
5. After downloading the configuration into the L-INX device, the L-IOB inputs and outputs can be checked with the L-INX Web UI. An example is shown in Figure 5.

The screenshot shows the LIOB Overview web interface. On the left is a navigation menu with options like Device Info, Data, Config, Statistics, L-WEB, L-IOB (with sub-options Overview, Installation, I/O Test), Reset, Contact, and Logout. The main content area is titled 'LIOB Overview' and contains a table of I/O modules. Above the table are buttons for 'Reload' and 'Reset All Count Values'. The table has columns for I/O Name, Term, Type, Value, Mode, and Status. The table lists various modules including temperature sensors (NTC, PT, Ni1000, Linear), frequency sensors, and digital/analog outputs (DI, AO, DO).

I/O Name	Term	Type	Value	Mode	Status
<b>LIOB1 (Online)</b> <input type="button" value="Reload"/> <input type="button" value="Reset Count Values"/>					
<a href="#">UI_Custom_NTC</a>	UI1	IN Analog/Digital 10V	25.30 °C	Auto	OK
<a href="#">UI_PT1000</a>	UI2	IN Analog/Digital 10V	-1.12 °C	Auto	OK
<a href="#">UI_NTC10K</a>	UI3	IN Analog/Digital 10V	20.22 °C	Auto	OK
<a href="#">UI_NTC1KΩ</a>	UI4	IN Analog/Digital 10V	25.23 °C	Auto	OK
<a href="#">UI_Ni1000</a>	UI5	IN Analog/Digital 10V	-2.03 °C	Auto	OK
<a href="#">UI_Linear</a>	UI6	IN Analog/Digital 10V	28.85 °C	Auto	OK
<a href="#">UI_Frequency</a>	UI7	IN Analog/Digital 10V	0.00 Hz	Auto	OK
<a href="#">UI_Trans_Table</a>	UI8	IN Analog/Digital 10V	39.96 °C	Auto	OK
<a href="#">DI_Digital</a>	DI1	IN Digital	OPEN	Auto	OK
<a href="#">DI_Pulse_Cnt</a>	DI2	IN Digital	0.00	Auto	OK
<a href="#">AO_Digital</a>	AO1	OUT Analog 12V	OFF	Auto	OK
<a href="#">AO_Analog</a>	AO2	OUT Analog 12V	0.00 V	Auto	OK
<a href="#">DO_Digital</a>	DO1	OUT Relais 6A	OPEN	Auto	OK
<a href="#">DO_PWM</a>	DO2	OUT Relais 6A	0.00 %	Auto	OK
<a href="#">manual</a>	DO3	OUT Relais 6A	OPEN	Manual	OK
<a href="#">override</a>	DO4	OUT Relais 6A	OPEN	Override	OK
<a href="#">disabled</a>	DO5	OUT Relais 6A	OPEN	Disabled	OK
<a href="#">unused</a>	DO6	OUT Triac	OPEN	Auto	OK
<a href="#">unused</a>	DO7	OUT Triac	OPEN	Auto	OK

Figure 5: Checking L-IOB inputs and outputs on the Web UI

## 3.2 Quick-Start Guide (LONMARK® Mode)

Observe that this quick-start guide only covers the LONMARK® device mode of LIOB-15x/45x models, see Section 5.1.

### 3.2.1 Hardware Installation

A LIOB-15x I/O module in LONMARK® device mode is connected to a CEA-709 network using the FT port of the L-IOB device. A LIOB-45x I/O module in LONMARK® device mode is connected to a CEA-852 network using the Ethernet/IP port of the L-IOB device, see Chapter 5. In both cases, the device must be powered e.g. using an LPOW-2415A power supply.

### 3.2.2 Commissioning

Use the appropriate L-IOB template of your LNS™ based network management tool (e.g. NL-220™ or LonMaker™) to create and commission a L-IOB device in the database. Once the device is created, the 'Configure' function of the network management tool can be used to invoke the Configurator Software.

### 3.2.3 Configuration

Configuration of the L-IOB devices is achieved using the L-INX Configurator software, see the corresponding user manual [1]. After startup, the Configurator will show the **LIOB Device** tab as depicted in Figure 6.

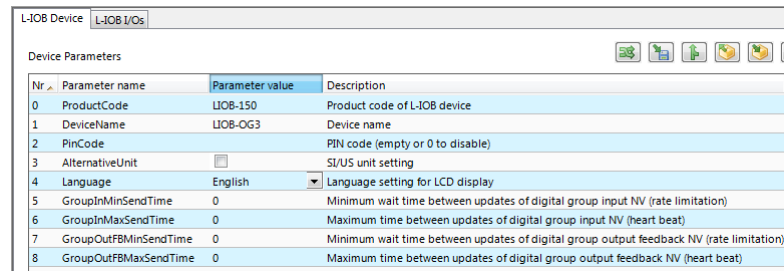

Nr.	Parameter name	Parameter value	Description
0	ProductCode	LIOB-150	Product code of L-IOB device
1	DeviceName	LIOB-OG3	Device name
2	PinCode		PIN code (empty or 0 to disable)
3	AlternativeUnit	<input type="checkbox"/>	SI/US unit setting
4	Language	English	Language setting for LCD display
5	GroupInMinSendTime	0	Minimum wait time between updates of digital group input NV (rate limitation)
6	GroupInMaxSendTime	0	Maximum time between updates of digital group input NV (heart beat)
7	GroupOutFBMinSendTime	0	Minimum wait time between updates of digital group output feedback NV (rate limitation)
8	GroupOutFBMaxSendTime	0	Maximum time between updates of digital group output feedback NV (heart beat)

Figure 6: LIOB Device Tab

In the **Device Parameters** table, the device specific configuration properties can be set.

### To Configure L-IOB I/Os

1. Select the **LIOB I/Os** tab.

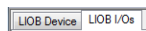

2. The **LIOB I/Os** tab displays the I/Os available on that L-IOB device in the **Inputs / Outputs** list.

Inputs / Outputs

Nr.	TerminalNr	Terminal	Name	Hardware type
1	1	UI1	UI1	IN Analog/Digital
2	2	GND12	GND UI1-UI2	IN Analog/Digital
3	3	UI2	UI2	IN Analog/Digital
4	4	UI3	UI3	IN Analog/Digital

3. To adapt the I/O name, double-click the name in the **Name** column and edit it, e.g., 'RoomTemp'.

Nr.	TerminalNr	Terminal	Name	Hardware type
1	1	UI1	RoomTemp	IN Analog/Digital

4. Select (or multi-select) an I/O in the **Inputs/Outputs** list and observe the **Object parameters** list below. These parameters can be used to configure the I/O.

Object parameters

Nr.	Parameter name	Parameter value	Unit	Range	Description
0	Name	RoomTemp			Terminal name
1	HardwareType	IN Analog/Digital			Terminal type
2	SignalType	Voltage 0-10V			Type of the input/output signal

5. Once the L-IOB configuration is finished, it can be downloaded into the connected L-IOB device using **Tools / Download Configuration**.
6. The data points of the L-IOB device are represented as network variables (NVs) and configuration properties (CPs). The NVs can now be polled or bound in the network management tool.

## 3.3 Quick-Start Guide (BACnet Mode)

Observe that this quick-start guide only covers the BACnet device mode of LIOB-55x models, see Section 5.1.

### 3.3.1 Hardware Installation

A LIOB-55x I/O module in BACnet device mode is connected to a BACnet/IP network using the Ethernet/IP port of the L-IOB device, see Chapter 5. The device must be powered e.g. using an LPOW-2415A power supply.

### 3.3.2 BACnet/IP Setup

Before the device can be used in the BACnet/IP network, the initial IP and BACnet setup must be done in the LCD UI (see Section 6.1) or Web UI (see Section 7.2).

### 3.3.3 Configuration

Configuration of the L-IOB devices is achieved using the L-INX Configurator software, see the corresponding user manual [1]. After startup of the Configurator, select the **L-IOB** tab as depicted in Figure 6.

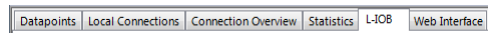
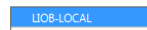

Figure 7: L-IOB Tab

#### To Configure L-IOB I/Os

1. Select 'LIOB-LOCAL' at the left side of the **L-IOB** tab.



2. The I/Os available on that L-IOB device are displayed in the **Inputs / Outputs** list.

Inputs / Outputs

Nr	TerminalNr	Terminal	Name	Hardware type
1	1	UI1	UI1	IN Analog/Digital
2	2	GND12	GND UI1-UI2	IN Analog/Digital
3	3	UI2	UI2	IN Analog/Digital
4	4	UI3	UI3	IN Analog/Digital

3. To adapt the I/O name, double-click the name in the **Name** column and edit it, e.g., 'RoomTemp'.

Nr	TerminalNr	Terminal	Name	Hardware type
1	1	UI1	RoomTemp	IN Analog/Digital

4. Select (or multi-select) an I/O in the **Inputs/Outputs** list and observe the **Object parameters** list below. These parameters can be used to configure the I/O.

Object parameters

Nr	DP Create	OPC	PLC In	PLC Out	Parameter name	Parameter value	Unit	Range	Description
0	<input type="checkbox"/>	<input type="checkbox"/>	<input type="checkbox"/>	<input type="checkbox"/>	Name	RoomTemp			Terminal name
1	<input type="checkbox"/>	<input type="checkbox"/>	<input type="checkbox"/>	<input type="checkbox"/>	HardwareType	IN Analog/Digital			Terminal type
2	<input type="checkbox"/>	<input type="checkbox"/>	<input type="checkbox"/>	<input type="checkbox"/>	SignalType	Voltage 0-10V			Type of the input/output signal

5. Once the L-IOB configuration is finished, it can be downloaded into the connected L-IOB device using **Tools / Download Configuration**.
6. The data points of the L-IOB device are represented as BACnet input or output server objects of the appropriate type according to the I/O configuration.

# 4 Hardware Installation

## 4.1 Enclosure

The L-IOB enclosures are 107 mm wide for DIN rail mounting, following DIN 43 880. Figure 8 shows the LIOB-100 enclosure as an example.

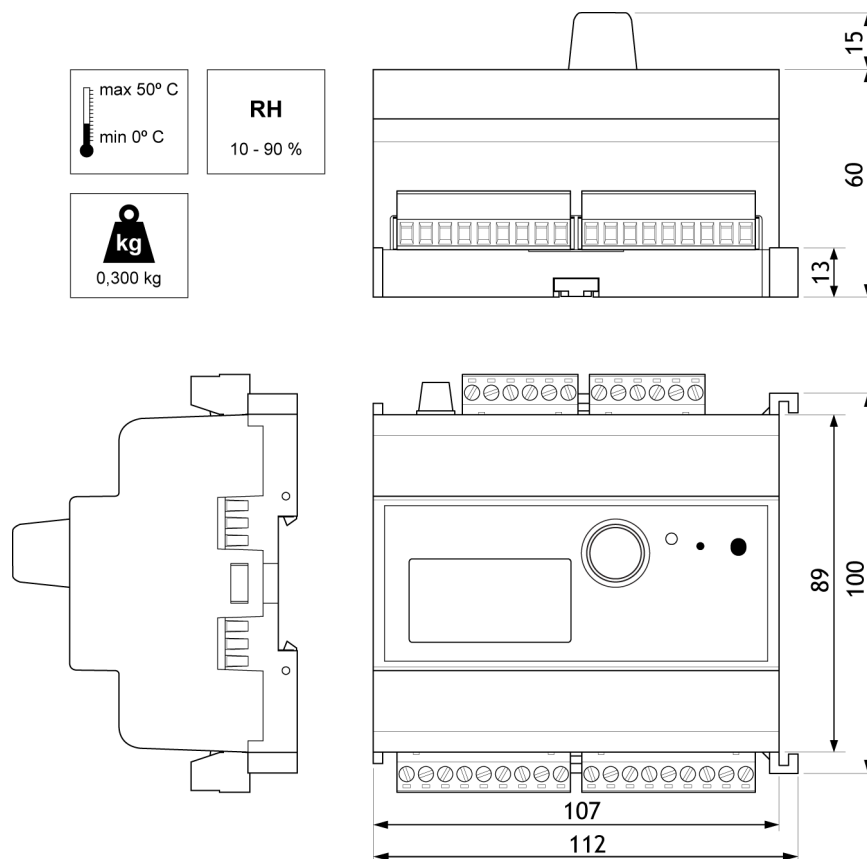

Figure 8: LIOB-100 Enclosure (dimensions in mm)

## 4.2 Product Label

The product label on the side of the L-IOB I/O module contains the following information (see Figure 9):

- L-IOB order number (e.g.: LIOB-100, LIOB-150, etc.),

- Date Code, which defines the production week and year,
- Serial number with bar-code (SER#),
- Node ID of the device. Models with an Ethernet/IP interface additionally contain the MAC address on the label.

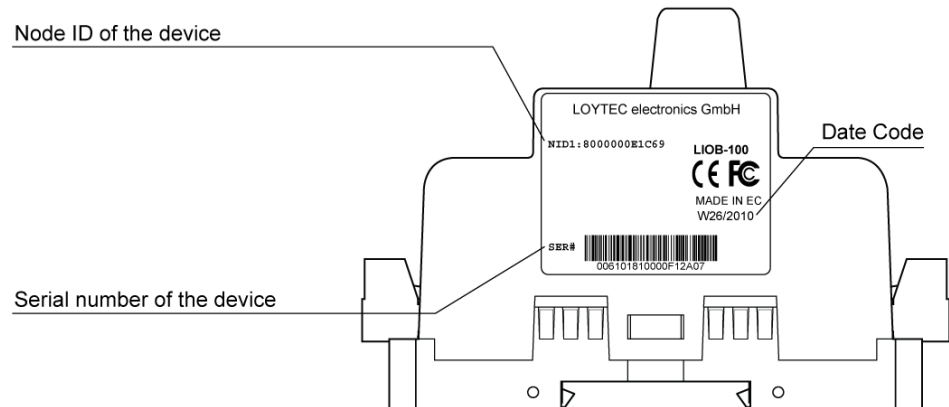

Figure 9: L-IOB product label

Unless stated otherwise, all bar codes are encoded using “Code 128”. An additional label is also supplied with the L-IOB for documentation purposes.

---

## 4.3 Mounting

All L-IOB devices come prepared for mounting on DIN rails following DIN EN 50 022. The devices can be mounted in any position. However, an installation place with proper airflow must be selected to ensure that the L-IOB’s temperature does not exceed the specified range (see Section 17.4).

---

## 4.4 Terminal Layout

The L-IOB device provides pluggable screw terminals to connect to sensor and actuator hardware. The screw terminals can be used for wires of a maximum thickness of 2.5 mm<sup>2</sup>/AWG13. Refer to Section 17.1 for the specification of all I/O hardware types. The next sections show the terminal layouts for the different L-IOB models.

### 4.4.1 LIOB-100

The LIOB-100 is connected to the L-INX via the LIOB-Connect bus. The terminal layout of the LIOB-100 is shown in Figure 10.

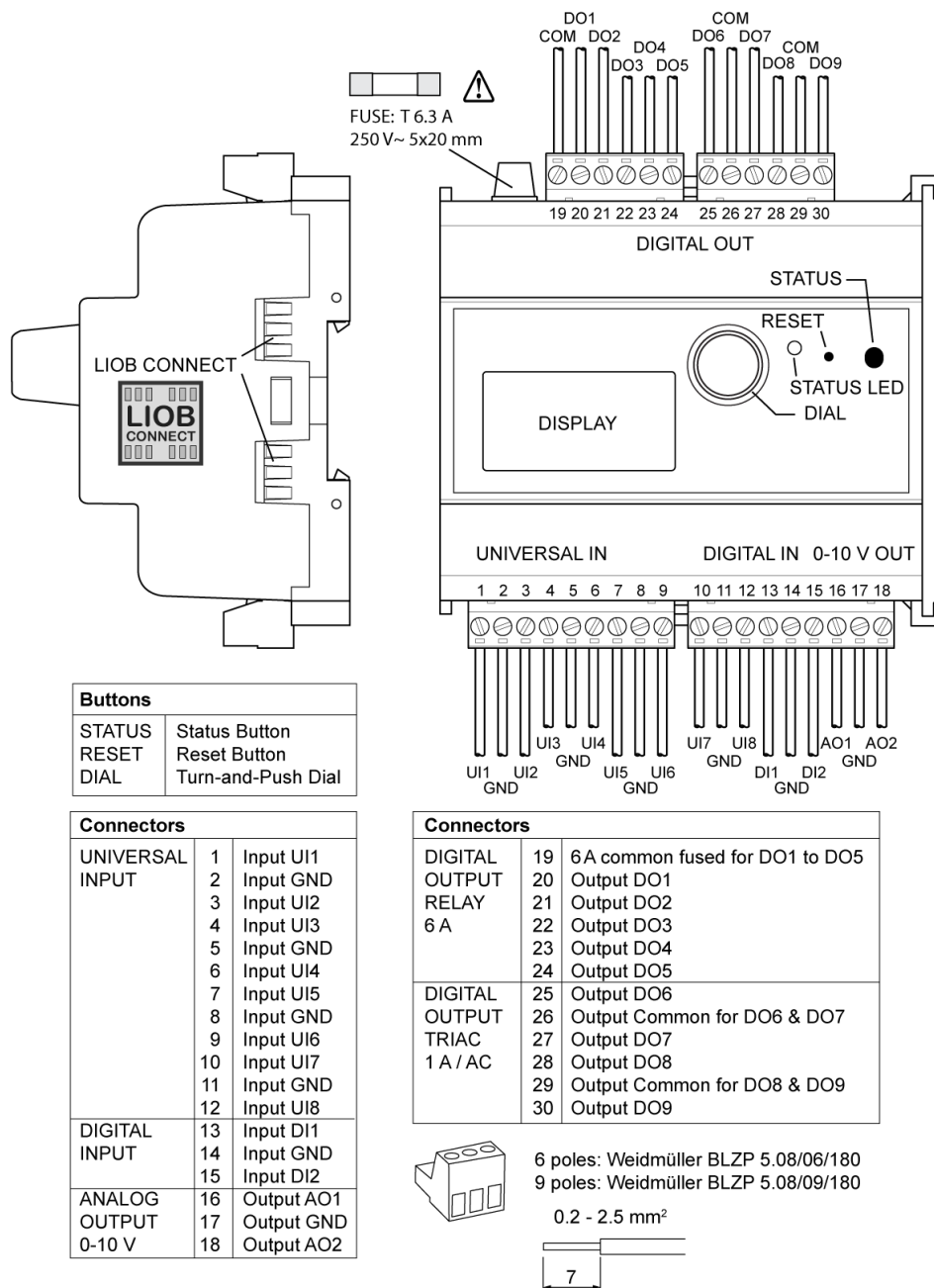

Figure 10: LIOB-100 terminal layout



### 4.4.2 LIOB-101

The LIOB-101 is connected to the L-INX via the LIOB-Connect bus. The terminal layout of the LIOB-101 is shown in Figure 11.

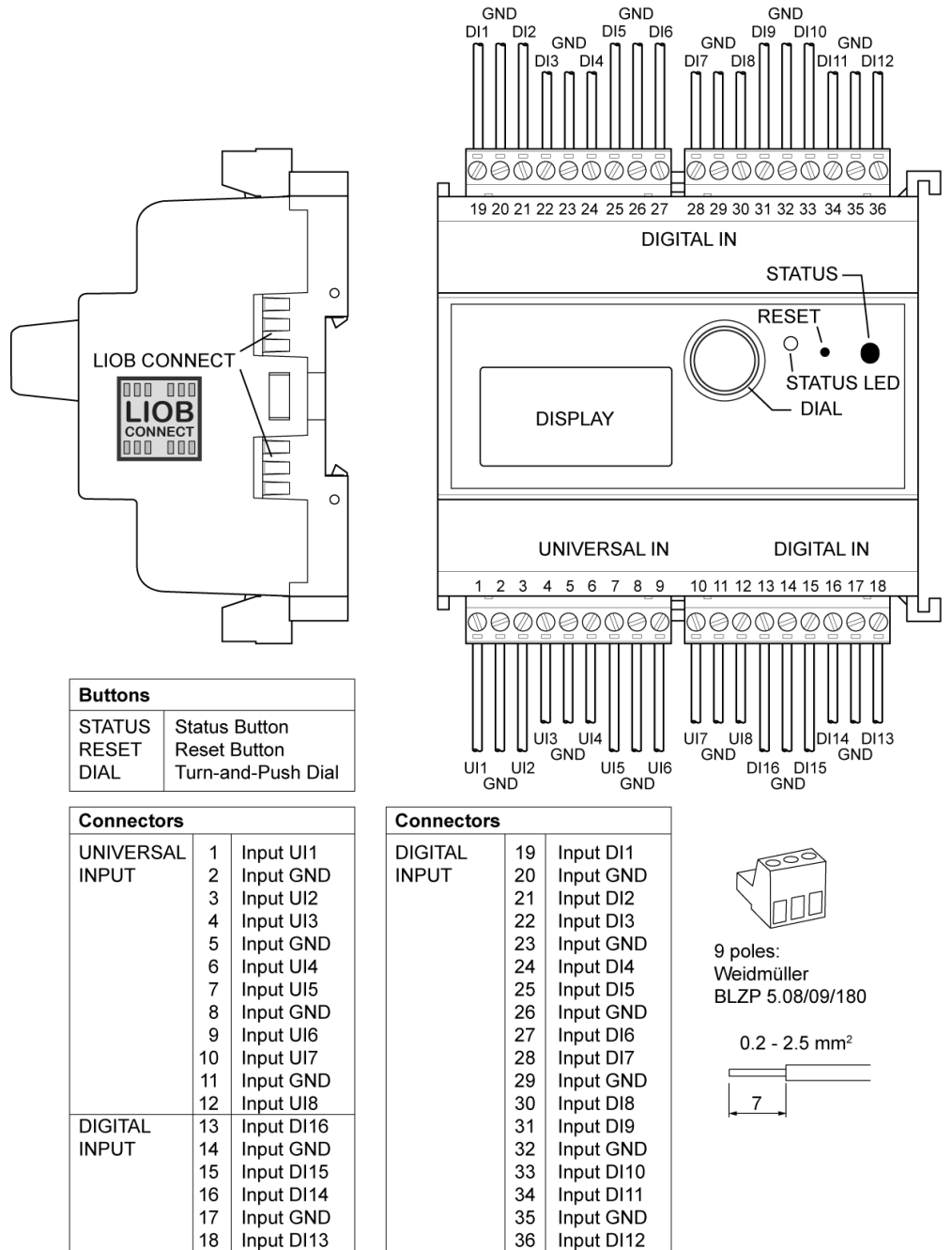

Figure 11: LIOB-101 terminal layout

### 4.4.3 LIOB-102

The LIOB-102 is connected to the L-INX via the LIOB-Connect bus. The terminal layout of the LIOB-102 is shown in Figure 12.

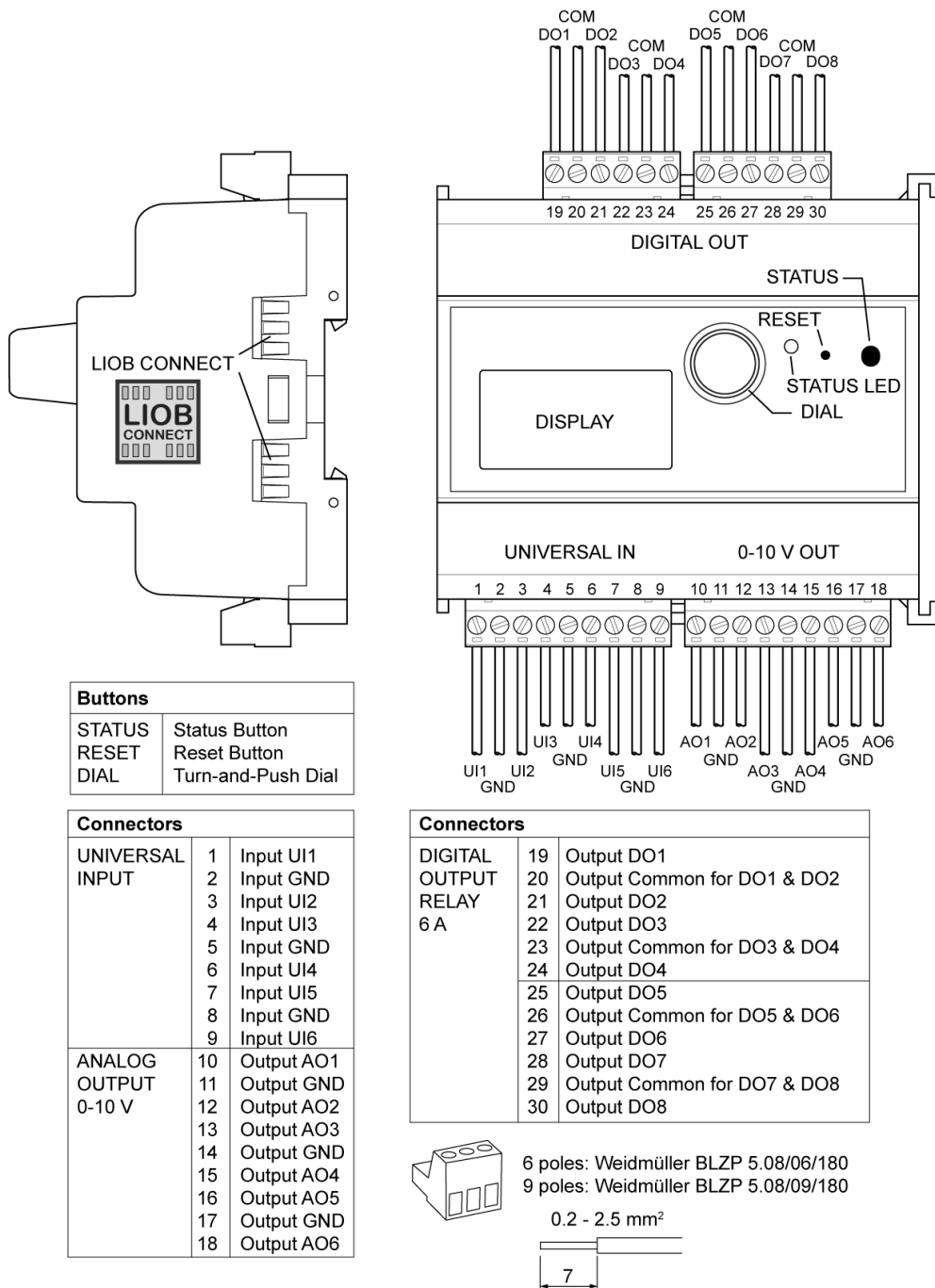

Figure 12: LIOB-102 terminal layout

### 4.4.4 LIOB-103

The LIOB-103 is connected to the L-INX via the LIOB-Connect bus. The terminal layout of the LIOB-103 is shown in Figure 13.

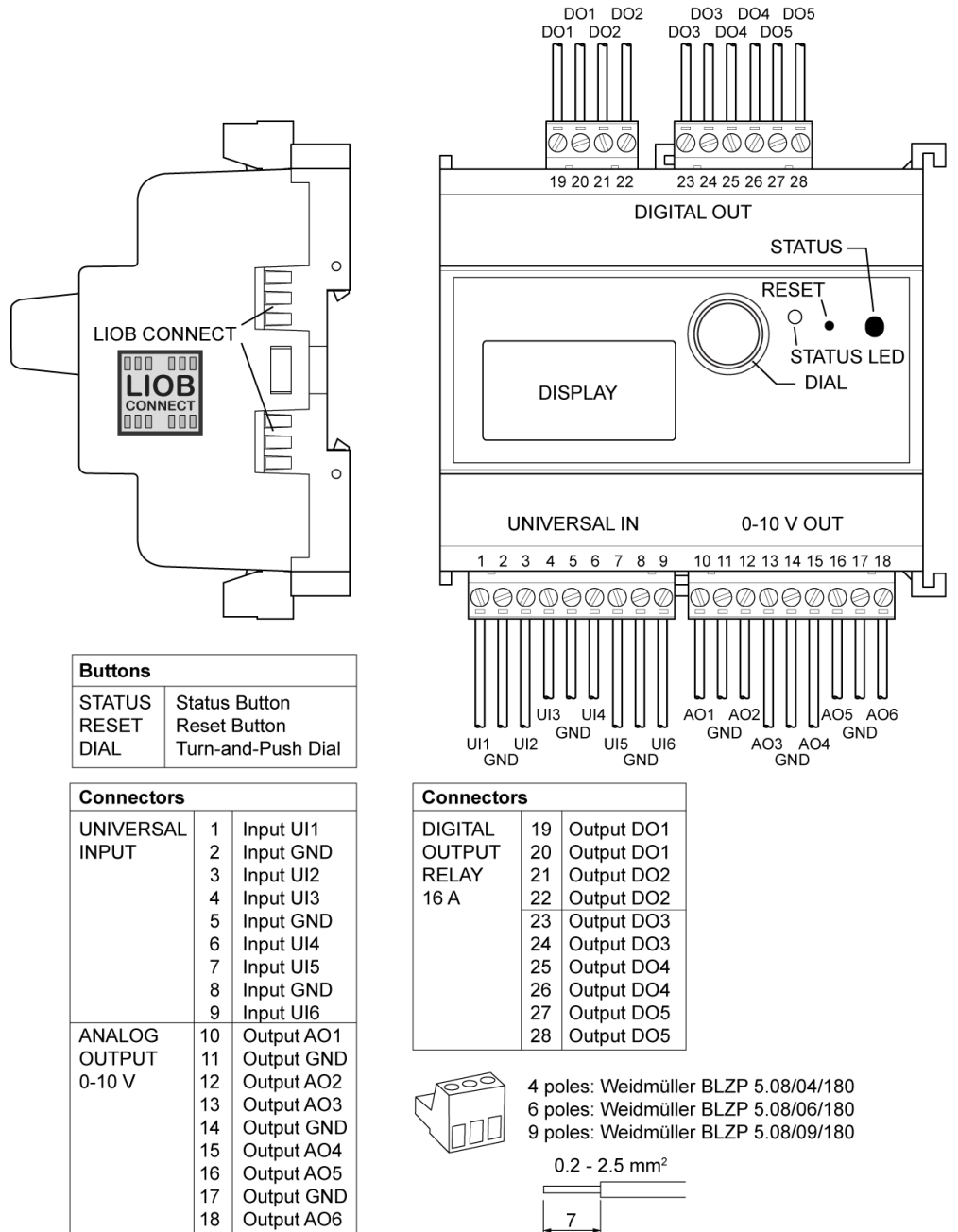

Figure 13: LIOB-103 terminal layout

### 4.4.5 LIOB-150

The LIOB-150 is either connected to the L-INX via the LIOB-FT bus (LIOB-FT device mode) or to any CEA-709 FT network (LONMARK® / Non-ECS device modes). The terminal layout of the LIOB-150 is shown in Figure 14.

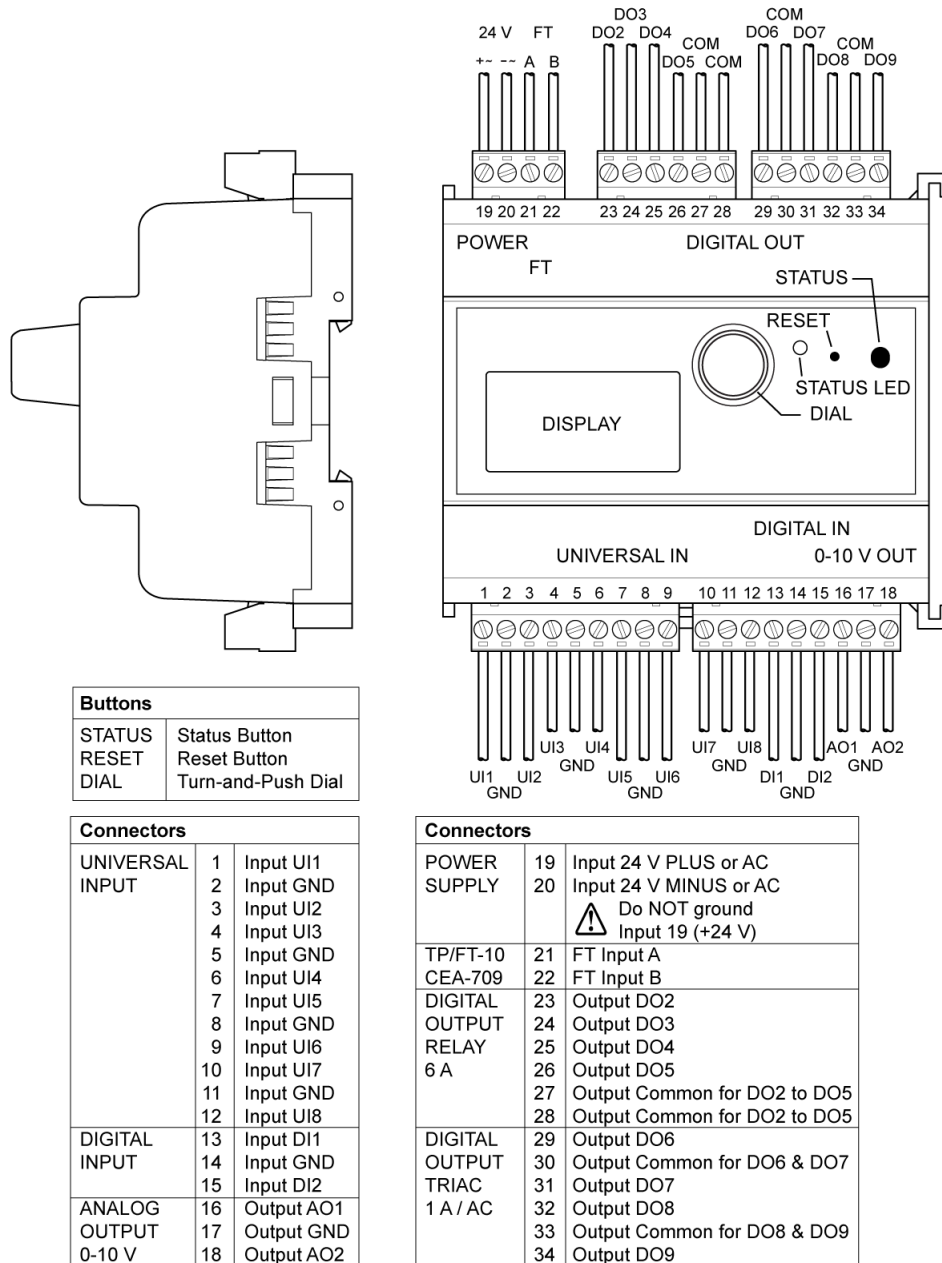

Figure 14: LIOB-150 terminal layout

### 4.4.6 LIOB-151

The LIOB-151 is either connected to the L-INX via the LIOB-FT bus (LIOB-FT device mode) or to any CEA-709 FT network (LONMARK® / Non-ECS device modes). The terminal layout of the LIOB-151 is shown in Figure 15.

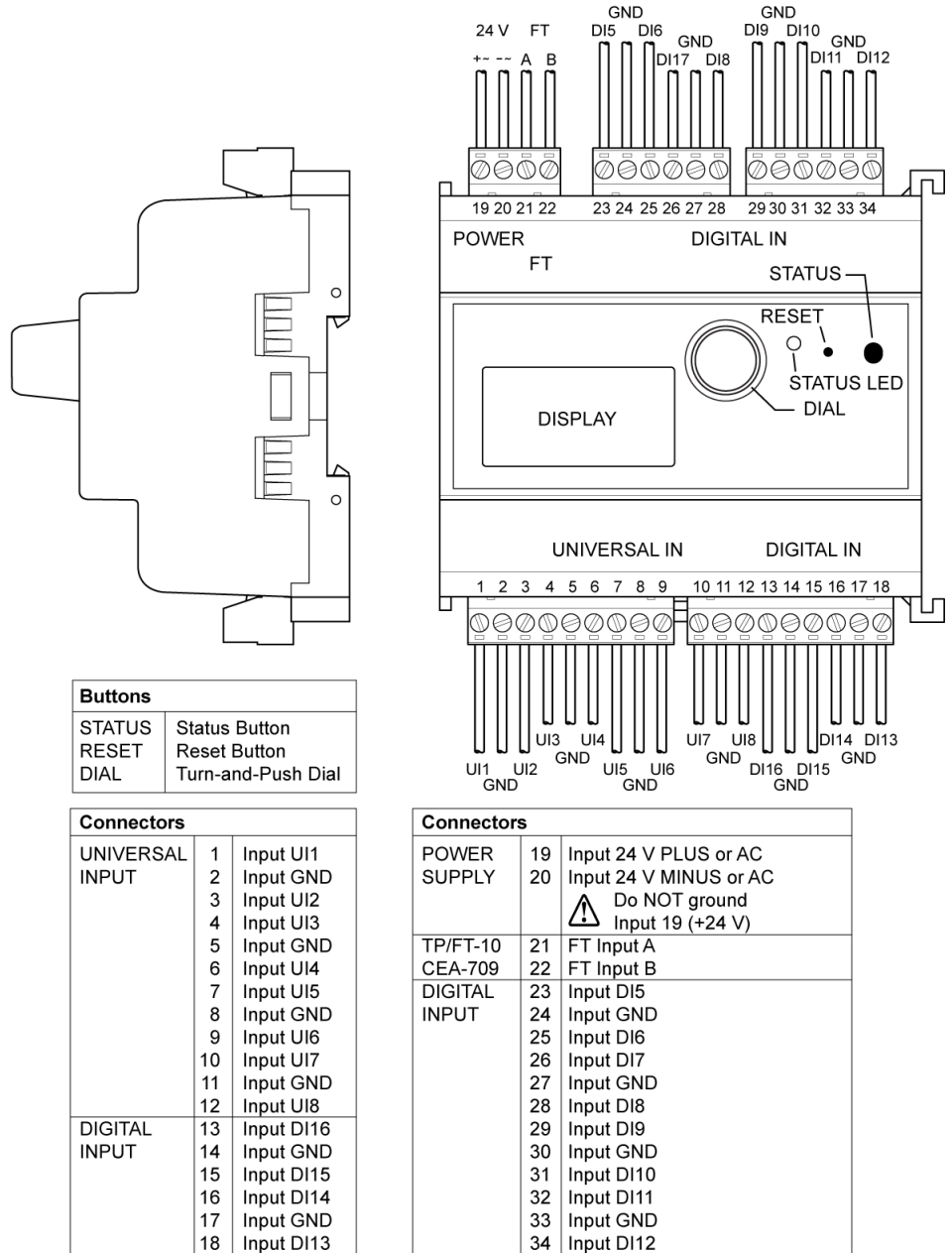

Figure 15: LIOB-151 terminal layout

### 4.4.7 LIOB-152

The LIOB-152 is either connected to the L-INX via the LIOB-FT bus (LIOB-FT device mode) or to any CEA-709 network (LONMARK® / Non-ECS device modes). The terminal layout of the LIOB-152 is shown in Figure 16.

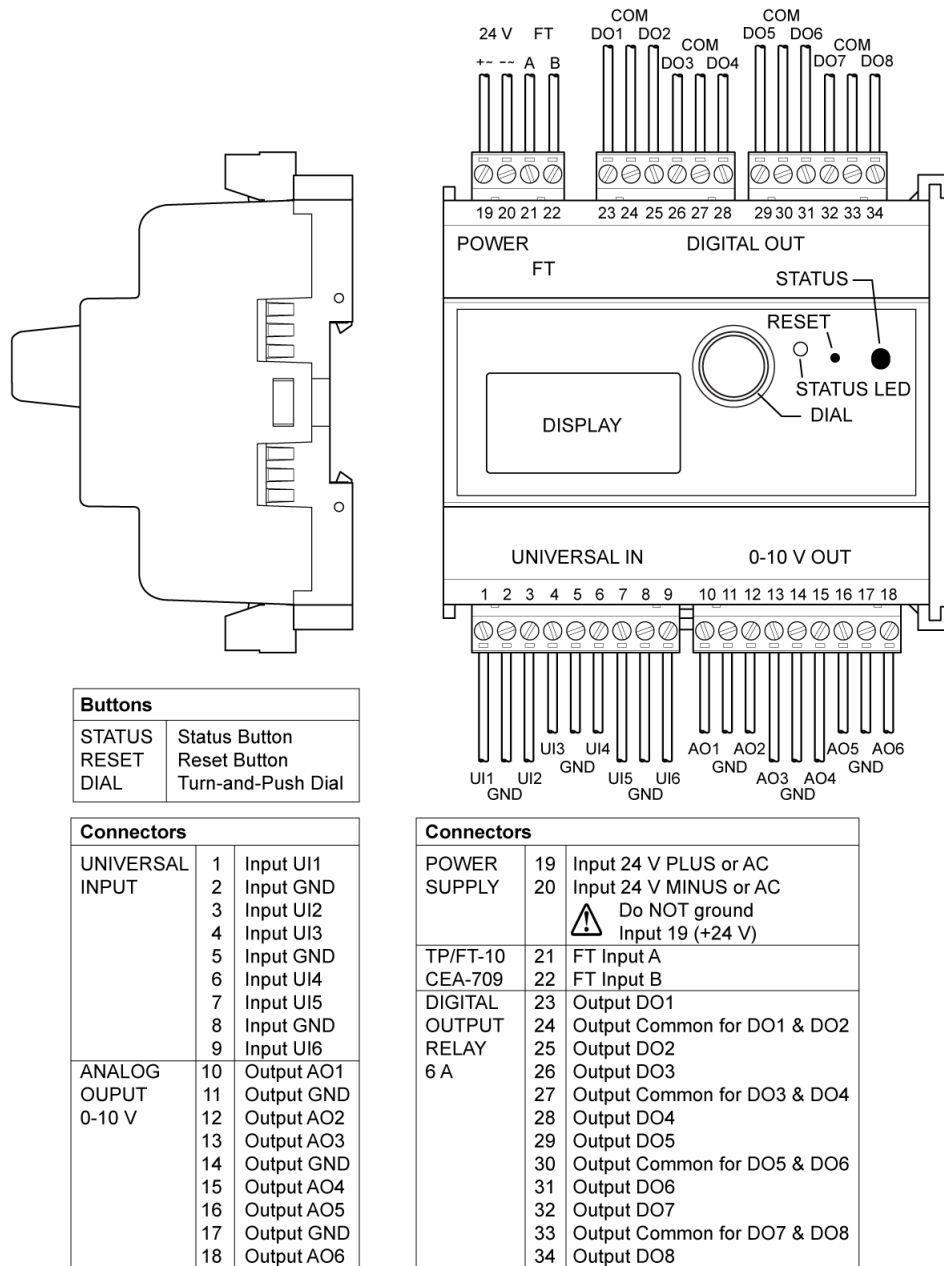

Figure 16: LIOB-152 terminal layout

### 4.4.8 LIOB-153

The LIOB-153 is either connected to the L-INX via the LIOB-FT bus (LIOB-FT device mode) or to any CEA-709 network (LONMARK® / Non-ECS device modes). The terminal layout of the LIOB-153 is shown in Figure 17.

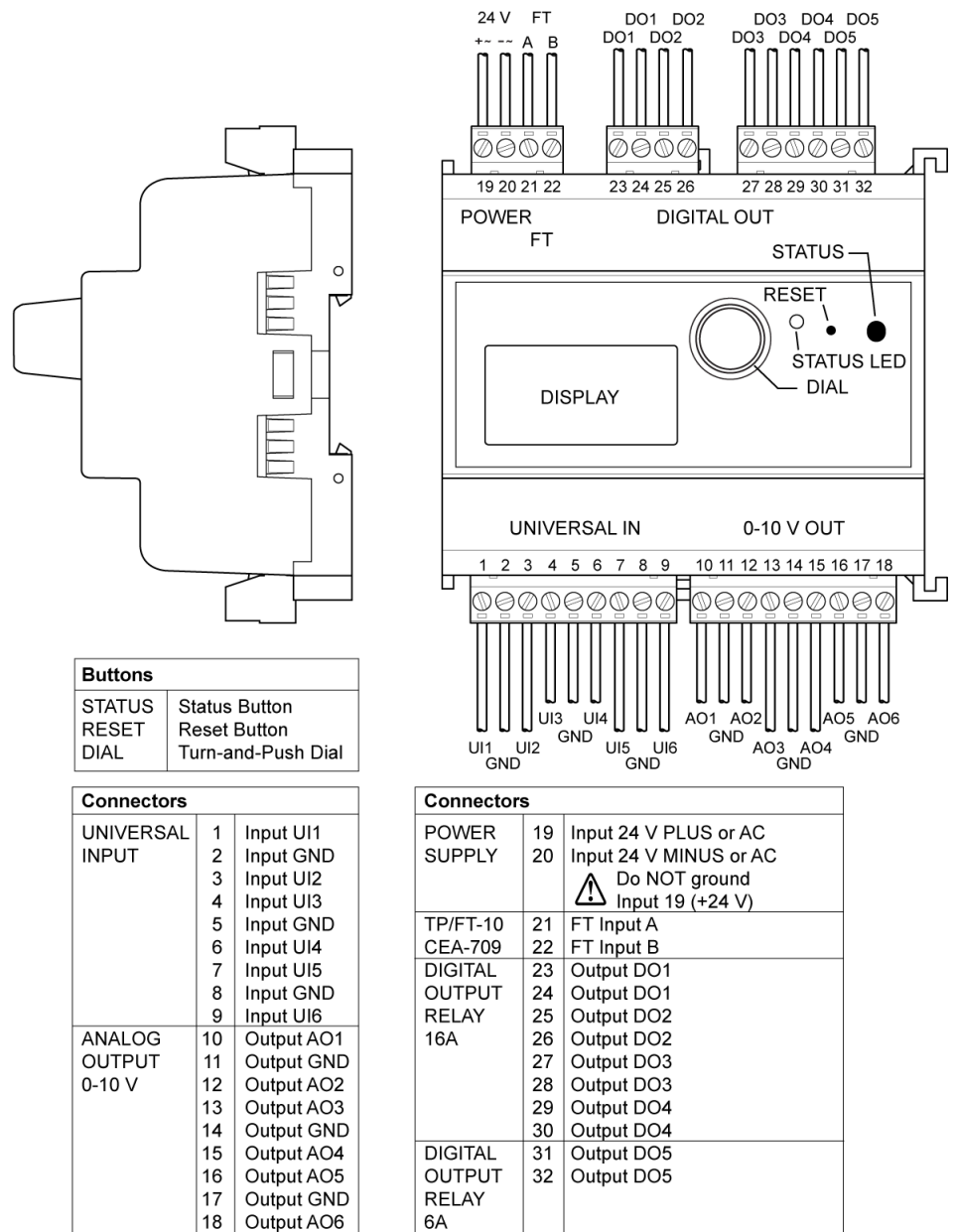

Figure 17: LIOB-153 terminal layout

### 4.4.9 LIQB-154

The LIQB-154 is either connected to the L-INX via the LIQB-FT bus (LIQB-FT device mode) or to any CEA-709 network (LONMARK® / Non-ECS device modes). The terminal layout of the LIQB-154 is shown in Figure 18.

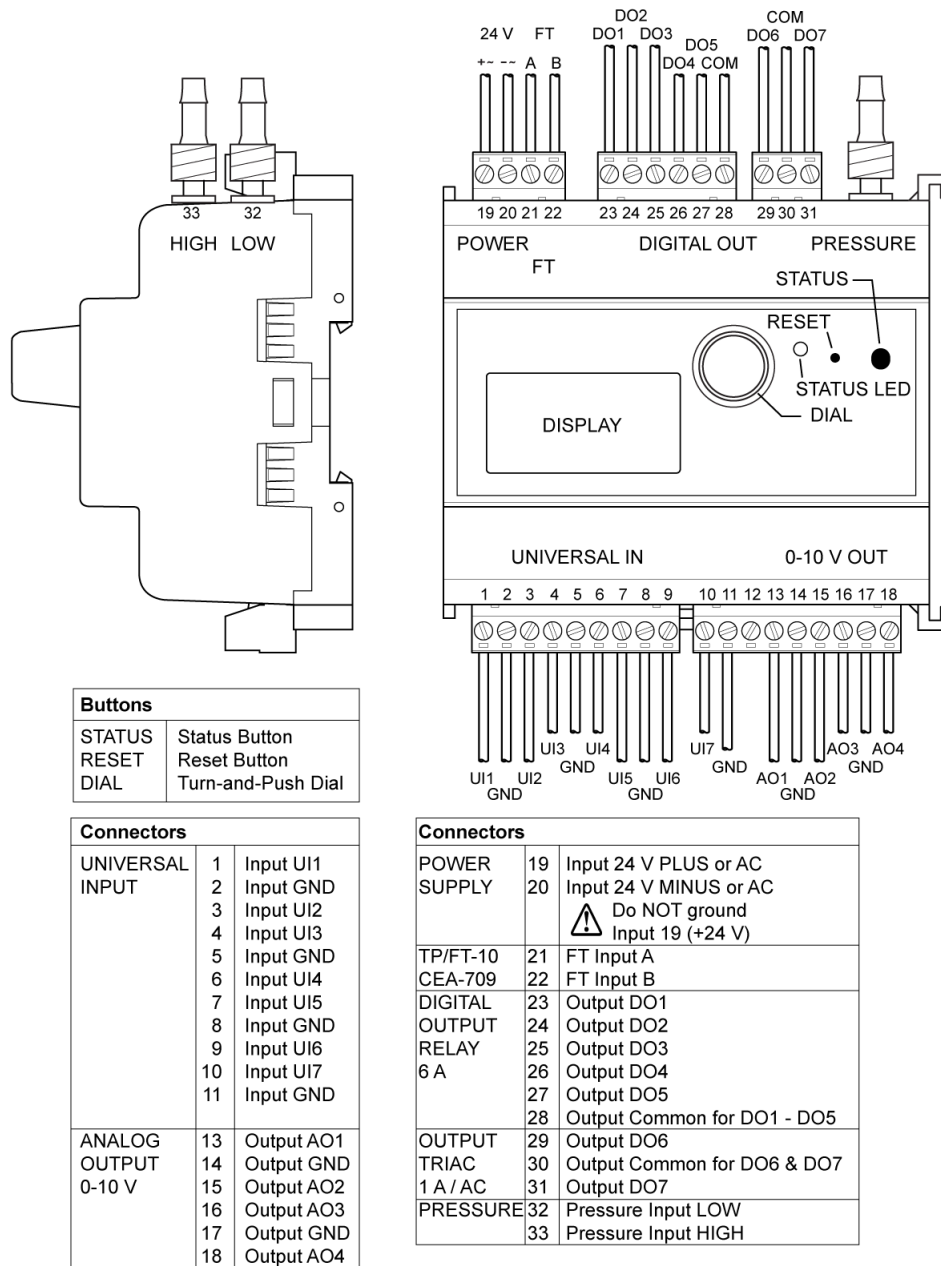

Figure 18: LIQB-154 terminal layout



### 4.4.10 LIOB-450/550

The LIOB-450/550 is either connected to the L-IOB host via the LIOB-IP protocol (LIOB-IP device mode), directly to a CEA-852 network (LONMARK® / Non-ECS device modes of LIOB-450), or to a BACnet/IP network (BACnet device mode of LIOB-550). In all cases, the physical connection is done via Ethernet/IP. The terminal layout of the LIOB-450/550 is shown in Figure 19.

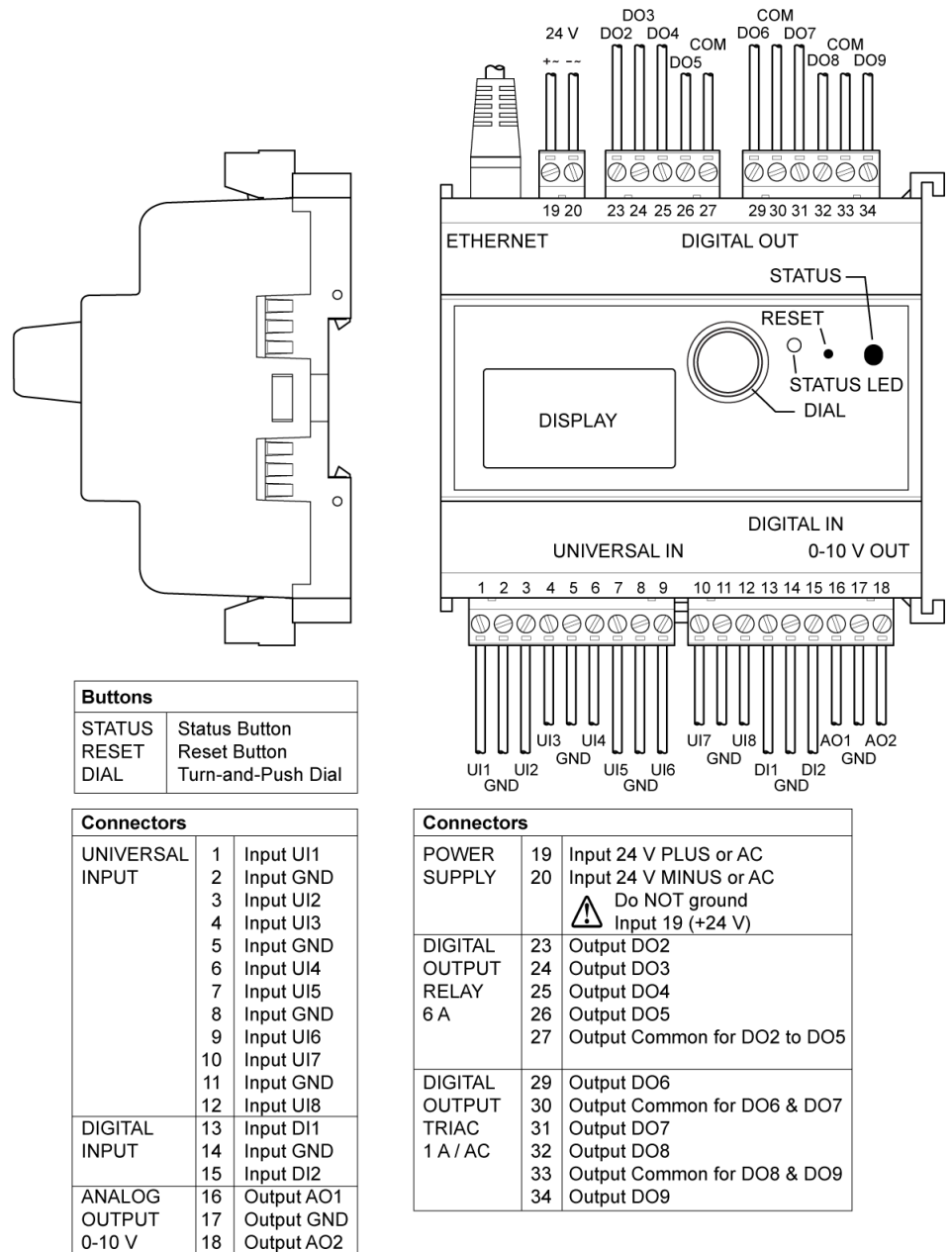

Figure 19: LIOB-450/550 terminal layout

### 4.4.11 LIOB-451/551

The LIOB-451/551 is either connected to the L-IOB host via the L-IOB-IP protocol (LIOB-IP device mode), directly to a CEA-852 network (LONMARK® / Non-ECS device modes of LIOB-451), or to a BACnet/IP network (BACnet device mode of LIOB-551). In all cases, the physical connection is done via Ethernet/IP. The terminal layout of the LIOB-451/551 is shown in Figure 20.

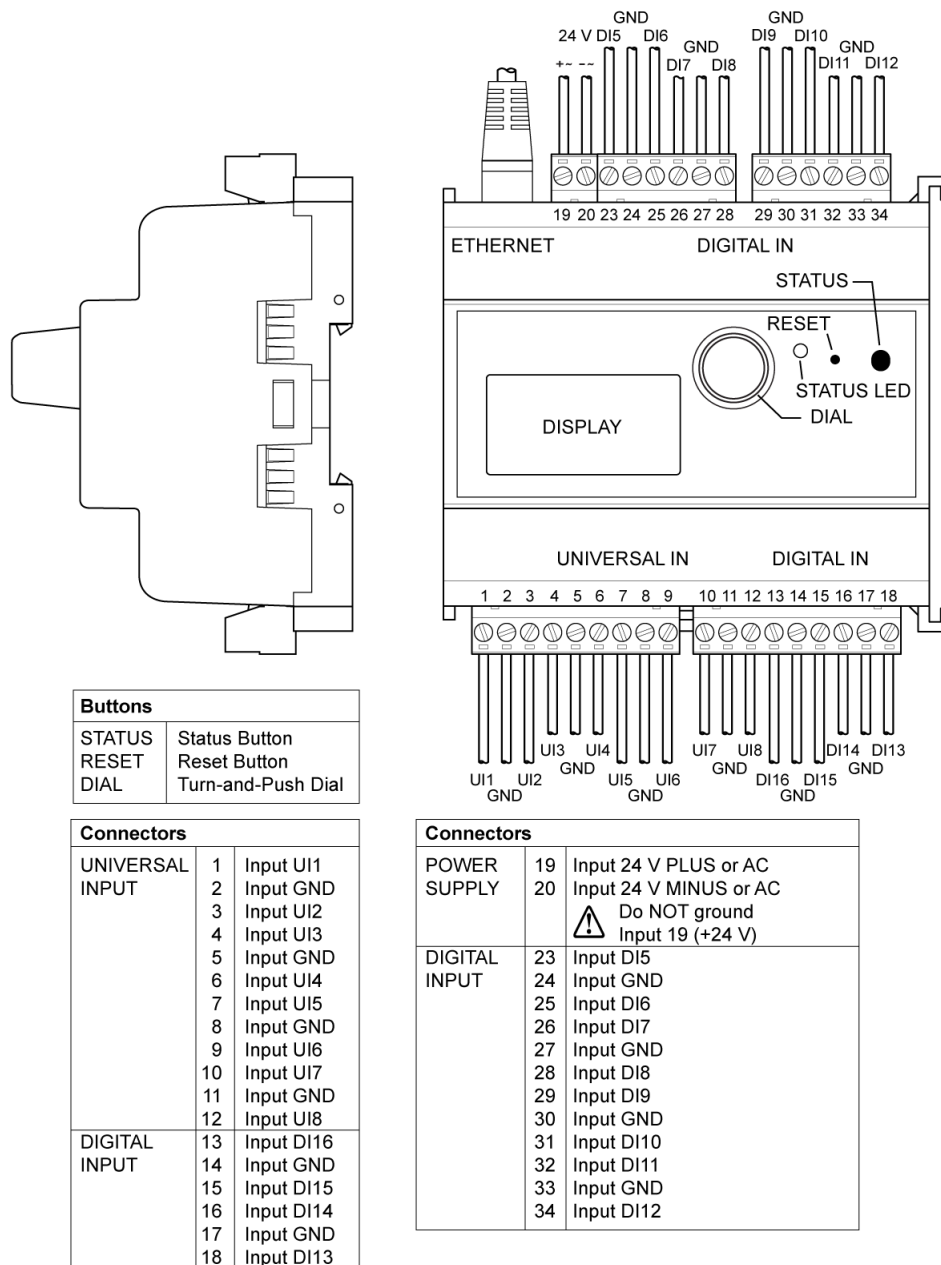

Figure 20: LIOB-451/551 terminal layout

### 4.4.12 LIOB-452/552

The LIOB-452/552 is either connected to the L-IOB host via the LIOB-IP protocol (LIOB-IP device mode), directly to a CEA-852 network (LONMARK® / Non-ECS device modes of LIOB-452), or to a BACnet/IP network (BACnet device mode of LIOB-552). In all cases, the physical connection is done via Ethernet/IP. The terminal layout of the LIOB-452/552 is shown in Figure 21.

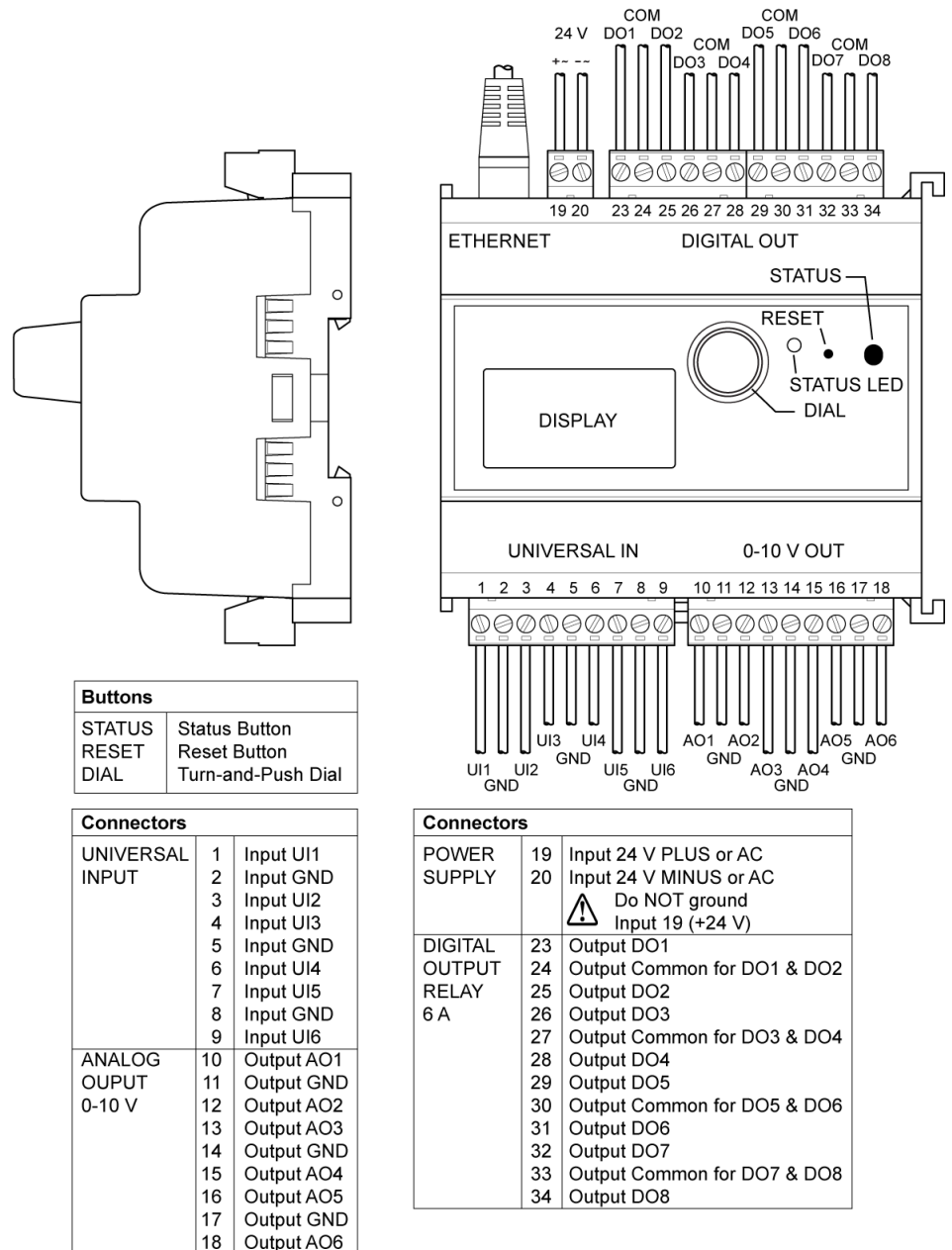

Figure 21: LIOB-452/552 terminal layout

### 4.4.13 LIOB-453/553

The LIOB-453/553 is either connected to the L-IOB host via the L-IOB protocol (LIOB-IP device mode), directly to a CEA-852 network (LONMARK® / Non-ECS device modes of LIOB-453), or to a BACnet/IP network (BACnet device mode of LIOB-553). In all cases, the physical connection is done via Ethernet/IP. The terminal layout of the LIOB-453/553 is shown in Figure 22.

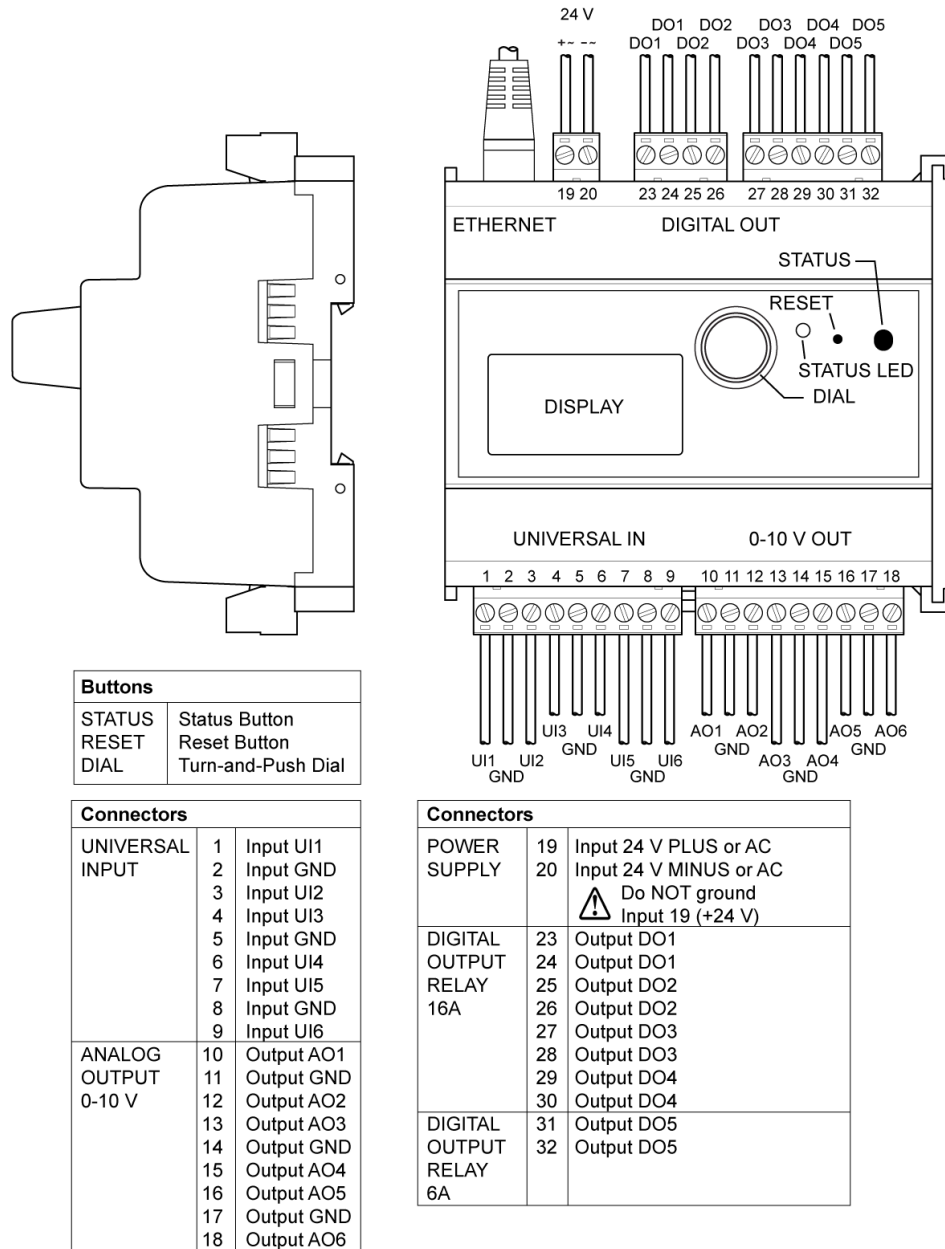

Figure 22: LIOB-453/553 terminal layout

**4.4.14 LIOB-454/554**

The LIOB-454/554 is either connected to the L-IOB host via the LIOB-IP protocol (LIOB-IP device mode), directly to a CEA-852 network (LONMARK® / Non-ECS device modes of LIOB-454), or to a BACnet/IP network (BACnet device mode of LIOB-554). In all cases, the physical connection is done via Ethernet/IP. The terminal layout of the LIOB-454/554 is shown in Figure 23.

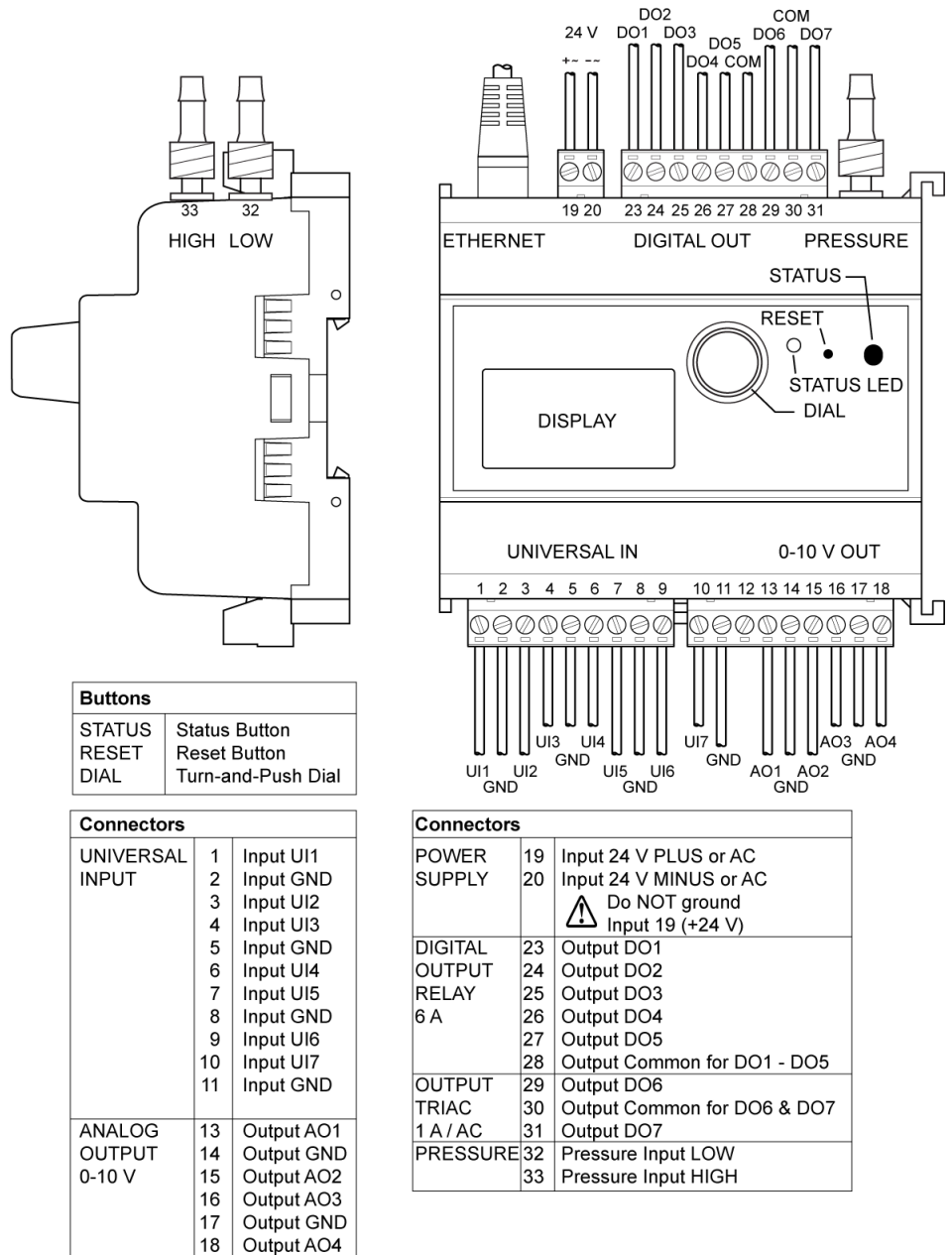

Figure 23: LIOB-454/554 terminal layout

#### 4.4.15 LIOB-A2

The LIOB-A2 adapter can be used to extend the LIOB-Connect bus and to connect an external power supply. Figure 24 shows the front view of the LIOB-A2.



Figure 24: LIOB-A2 front view

On the “24 VDC INPUT” terminal, a 24 VDC power supply can optionally be connected to supply L-IOB devices with power when not using an L-POW power supply. 3<sup>rd</sup> party devices (up to 200 mA in total), which also need a 24 VDC power supply, can be connected to the “24 VDC / 200mA OUTPUT”.

At the bottom of the LIOB-A2, a 4-wire cable (“SEL”, “GND”, “A”, “B”) can be connected to extend the LIOB-Connect bus as shown in Figure 25. When the cable is longer than 1 m, it is necessary to terminate the LIOB-Connect bus at the end. This is achieved by using another LIOB-A2 and connecting the “B” with the “TERM” terminal, as shown at the bottom right of Figure 25.

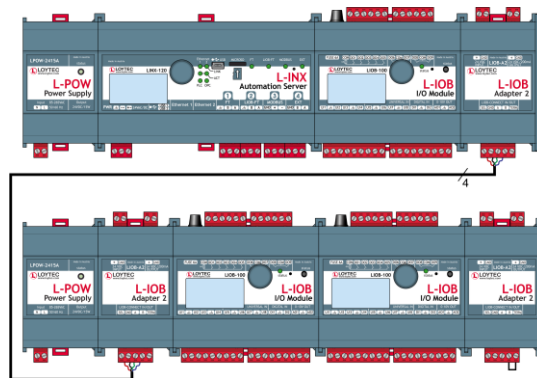

Figure 25: Using the LIOB-A2 adapter to extend the LIOB-Connect bus

More information about LIOB-Connect wiring can be found in Section 4.5.

## 4.5 Power Supply and Wiring

Please refer to Section 17.3 on how many L-IOB devices can be connected to a L-IOB host. There are six ways of connecting L-IOB devices:

- to the LIOB-Connect port of a L-IOB host (LIOB-10x),

- to the LIOB-FT port of a L-IOB host (LIOB-15x in LIOB-FT device mode),
- to a CEA-709 network (LIOB-15x in LONMARK® or Non-ECS device mode),
- to the LIOB-IP bus of a L-IOB host (LIOB-45x/55x in LIOB-IP device mode),
- to a CEA-852 network (LIOB-45x in LONMARK® or Non-ECS device mode),
- to a BACnet/IP network (LIOB-55x in BACnet device mode).

**The LIOB-Connect port** of a L-IOB host provides a means for connecting LIOB-10x modules, including power supply and communication, without further cabling needs. The gold contacts at the side of the enclosure attach the modules in a daisy chain. Up to 24 L-IOB devices can be connected to the LIOB-Connect port. The LIOB devices are physically and logically organized in a daisy chain. This means that the L-IOB host is able to automatically enumerate the connected I/O modules to match the order defined in the Configurator.

**The LIOB-FT port** of a L-IOB host is used to overcome longer distances between the L-IOB host and the L-IOB I/O modules (LIOB-15x models in LIOB-FT device mode). Depending on the L-IOB host, up to 8 or 24 L-IOB devices can be attached over LIOB-FT. The cable type, topology, and length are in accordance with the TP/FT-10 specification. The LIOB-FT modules need additional setup (Station ID), as explained in Chapter 5.

**The CEA-709 Network Connection** is available for the LIOB-15x models in LONMARK® or Non-ECS device mode. The number of connectable devices, cable type, topology and length follow the TP/FT-10 specification. All rules of CEA-709 / LONMARK® devices regarding network installation, management, and maintenance apply. A L-IOB host is not required.

**The LIOB-IP port** of a L-IOB host is used to connect L-IOB devices over Ethernet/IP (LIOB-45x/55x models in LIOB-IP device mode). Depending on the L-IOB host, up to 8 or 24 L-IOB devices can be attached over LIOB-IP. The LIOB-IP modules need additional setup (e.g. IP address, Station ID), as explained in Chapter 5.

**The CEA-852 Network Connection** is available for the LIOB-45x models in LONMARK® or Non-ECS device mode. All rules of CEA-852 / LONMARK® devices regarding network installation, management, and maintenance apply. A L-IOB host is not required.

**The BACnet/IP Network Connection** is available for the LIOB-55x models in BACnet device mode. All rules of BACnet devices regarding network installation, management, and maintenance apply. A L-IOB host is not required.

Please refer to Section 6.4 for setting up the correct device mode in LIOB-15x/45x/55x models. For using external (non-LOYTEC) power supplies, please refer to Section 15.1. For connecting sensors and actuators to the L-IOB I/Os, please refer to Sections 15.2 and 15.3. The next Sections describe the different power supply and cabling variants in detail, depending on the connection method.

#### 4.5.1 LIOB-Connect without Extension

Up to 4 L-IOB devices can be directly connected to the L-INX device in a physical daisy chain as depicted in Figure 26.

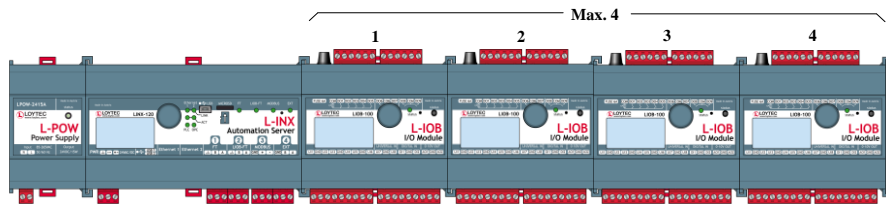

Figure 26: LIOB-Connect Daisy Chain

The LPOW-2415A power supply to the left is equipped with a LIOB-Connect port and can be attached to the L-INX for powering both the L-INX and the L-IOB I/O modules.

### 4.5.2 LIOB-Connect with Extension

For space considerations or if the power supply is not sufficient for all connected L-IOB devices (more than 4), the LIOB-Connect chain can be split into two (or more) segments of modules using LIOB-A2 adapters and a 4-wire cable (“SEL”, “GND”, “A”, “B”) as depicted in Figure 27.

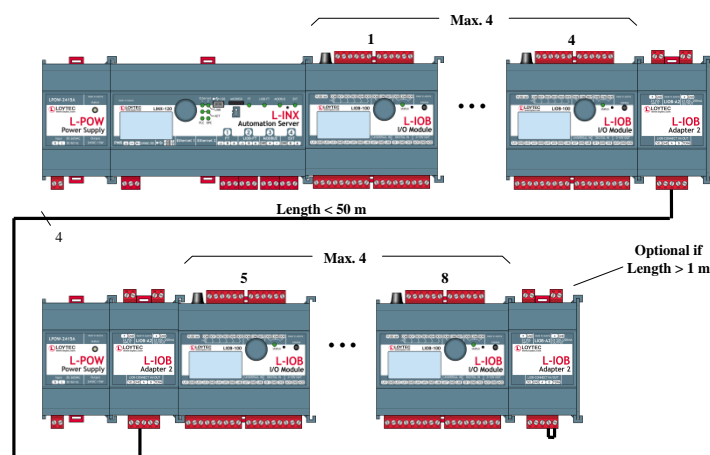

Figure 27: LIOB-Connect Extension

The total length of the extension cable must be smaller than 50 meters. If the length exceeds 1 meter, a LIOB-A2 adapter must be used at the end of the last segment as a termination, with terminals “B” and “TERM” connected, as depicted in the bottom right of Figure 27. Observe that the extension must be done exactly as depicted in Figure 27, even if it is just used for providing sufficient power supply and not to overcome space issues.

### 4.5.3 LIOB-FT in Free Topology

Figure 28 shows the connection of LIOB-15x modules (LIOB-FT device mode) to the LIOB-FT port of a L-INX device in free topology, which can be used for cable lengths of up to 500 m between any two devices.



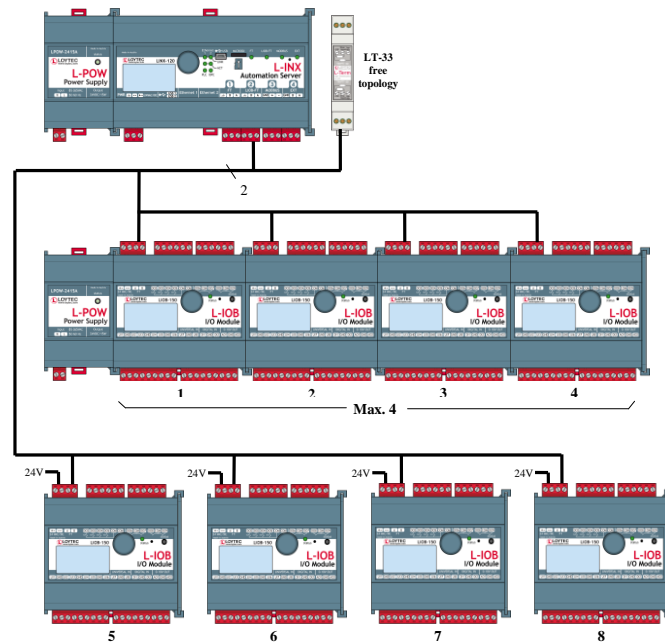

Figure 28: LIOB-FT Free Topology

The L-IOB devices can either be powered by L-POWs (middle part of Figure 28) or other 24 V power supplies (bottom part of Figure 28). The LIOB-FT port of the L-INX (terminals “A” and “B”) must be connected to all LIOB-15x devices. One LT-33 terminator (free topology terminals) must be placed somewhere in the network.

#### 4.5.4 LIOB-FT in Bus Topology

Figure 29 shows the connection of LIOB-15x modules (LIOB-FT device mode) to the LIOB-FT port of a L-INX device in bus topology, which must be used for a cable length of above 500 m. The L-IOB devices can either be powered by L-POWs (middle part of Figure 29) or other 24 V power supplies (bottom part of Figure 29). The LIOB-FT port of the L-INX (terminals “A” and “B”) must be connected to all LIOB-15x devices, forming a physical bus. An LT-33 terminator (bus topology terminals) must be placed at both ends of the bus.

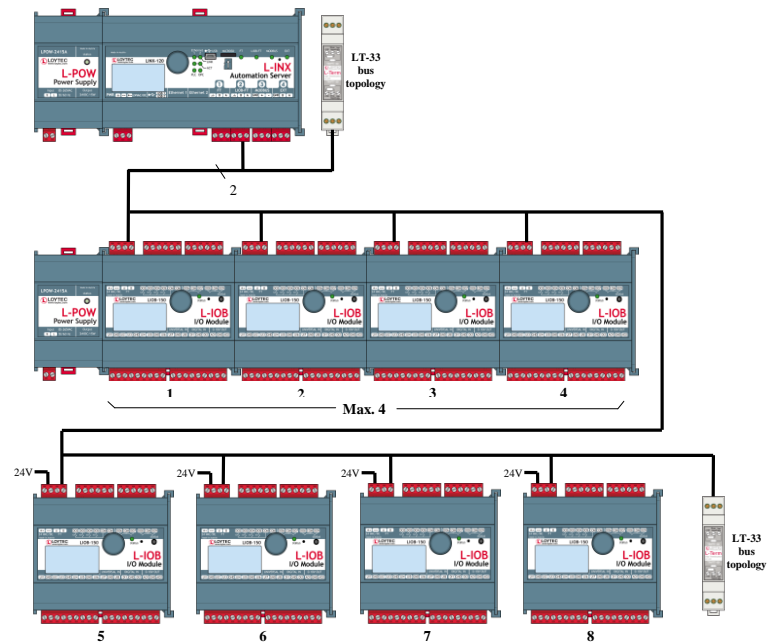

Figure 29: LIOB-FT Bus Topology

#### 4.5.5 CEA-709 Network Connection in Free Topology or Bus Topology

The connection of LIOB-15x devices in LONMARK® or Non-ECS device mode works exactly like in LIOB-FT device mode, refer to Sections 4.5.3 and 4.5.4. The only difference is that instead of the connection to the LIOB-FT port of a L-INX device, the L-IOB devices are directly connected to a CEA-709 network.

#### 4.5.6 LIOB-IP Connection

Figure 30 shows the connection of LIOB-45x/55x modules (LIOB-IP device mode) to a L-INX. Observe that communication over NAT routers is not supported for the LIOB-IP bus. The L-IOB devices can either be powered by L-POWs (middle part of Figure 30) or other 24 V power supplies (bottom part of Figure 30).

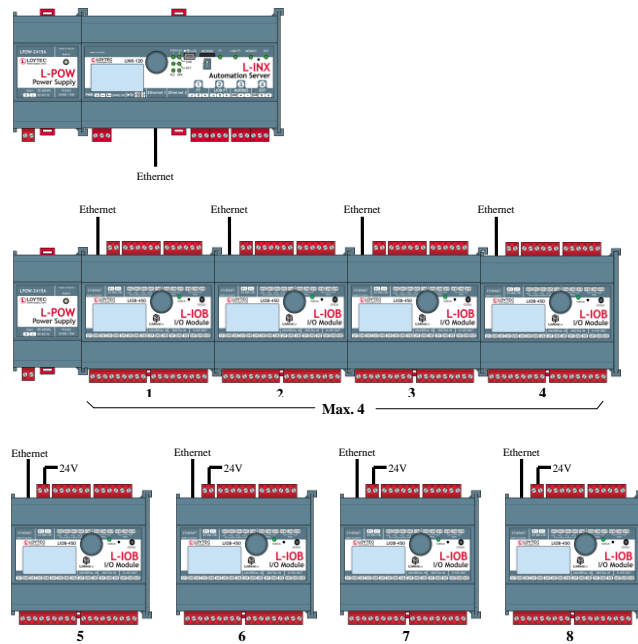

Figure 30: LIOB-IP Connection

#### 4.5.7 CEA-852 Network Connection

The connection of LIOB-45x devices in LONMARK® or Non-ECS device mode works exactly like in LIOB-IP device mode, refer to Section 4.5.6. A L-IOB host is not needed in this case. There could still be e.g. a L-INX device in the network acting as the CEA-852 configuration server though.

#### 4.5.8 BACnet/IP Network Connection

The connection of LIOB-55x devices in BACnet device mode works exactly like in LIOB-IP device mode, refer to Section 4.5.6. A L-IOB host is not needed in this case.

## 4.6 LED signals

The L-IOB device is equipped with a three-color status LED (see Figure 10) which indicates the current state of the L-IOB device.

#### 4.6.1 Status LED (L-INX Mode)

The meaning of the LED signals for the LIOB-10x models, the LIOB-15x models in LIOB-FT device mode, and the LIOB-45x/55x models in LIOB-IP device mode is listed in Table 1.

Behavior	Description	Comment
OFF	Unconfigured / Offline	The L-IOB device is either not connected to a L-IOB host or not yet set online.
GREEN	Normal Operation	The L-IOB device is connected to a L-IOB host and online. No I/O is in manual mode.
ORANGE	Manual Mode	At least one I/O is in manual mode.
RED	Error	An error has occurred (e.g. a sensor is disconnected or signals an error).
Flickering	Traffic	Indicates traffic between the L-IOB host and the L-IOB device.
RED flashing at 0.5 Hz	Fallback Override	The primary firmware image is corrupt and the L-IOB has booted the fallback image. In this case, the firmware must be upgraded again.

Table 1: Status LED Patterns in LIOB-Connect / LIOB-FT / LIOB-IP device mode

#### 4.6.2 Status LED (LonMARK® Mode)

The meaning of the LED signals for the LIOB-15x/45x models in LONMARK® or Non-ECS device mode is listed in Table 2.

Behavior	Description	Comment
OFF	Online	The L-IOB device is configured online.
Flickering	Traffic	The L-IOB device receives or transmits NV or CP values.
ORANGE	Manual Mode	At least one I/O is in manual mode.
RED	Error	An error has occurred (e.g. a sensor is disconnected or signals an error).
GREEN flashing at 0.5 Hz	Offline	The L-IOB device is offline.
RED flashing at 0.5 Hz	Fallback Override	The primary firmware image is corrupt and the L-IOB has booted the fallback image. In this case, the firmware must be upgraded again.

Table 2: Status LED Patterns in LONMARK® / Non-ECS device mode

#### 4.6.3 Status LED (BACnet Mode)

The meaning of the LED signals for the LIOB-55x models in BACnet device mode is listed in Table 3.

Behavior	Description	Comment
OFF	No Traffic	No packets are received or transmitted.
Flickering GREEN	Traffic	The L-IOB device receives or transmits packets.
ORANGE	Manual Mode	At least one I/O is in manual mode.
RED	Error	An error has occurred (e.g. a sensor is disconnected).
RED flashing at 0.5 Hz and "LIOB Fallback" shown in LCD UI	Fallback Override	The primary firmware image is corrupt and the L-IOB has booted the fallback image. In this case, the firmware must be upgraded again.

Table 3: Status LED Patterns in BACnet device mode

## 4.7 Status Button

The L-IOB device is equipped with a status button (see Figure 10). When pressing the status button shortly during normal operation of the device, a service pin message (LIOB-15x/45x) or I-Am message (LIOB-55x) is sent out, the LCD is reset, and the LCD backlight is switched on.

The status button can also be used to switch the device back to factory default state. Press the button and power-cycle the device. Keep the button pressed until the Status LED illuminates orange permanently. Release the button within five seconds from that time on to reset the device to factory defaults.

# 5 Device Modes and Installation

After physically installing and connecting the L-IOB devices, they must be configured to be able to communicate with each other resp. with the L-IOB host. The necessary steps depend on the used device mode. The available device modes and resulting installation steps as well as some remarks about device monitoring and replacement are documented in the next sections.

---

## 5.1 Device Modes

There are six different device modes available for L-IOB devices which are explained in the following sections. For LIOB-15x/45x/55x models, the device mode can be changed on the LCD Display, see Section 6.4. Observe that the LIOB-Connect / LIOB-FT / LIOB-IP device modes are abbreviated as '**L-INX Mode**', the LONMARK® / Non-ECS device modes are abbreviated as '**LONMARK® Mode**', and the BACnet device mode is abbreviated as '**BACnet Mode**'.

### 5.1.1 LIOB-Connect Device Mode (LIOB-10x)

This is the only available device mode for LIOB-10x devices. It requires a L-IOB host. The L-IOB devices are directly connected to the host as described in Section 4.5.

### 5.1.2 LIOB-FT Device Mode (LIOB-15x)

This mode is similar to the LIOB-Connect device mode of LIOB-10x devices. It also requires a L-IOB host. The difference is that the connection between the LIOB host and the L-IOB devices is done over the LIOB-FT port instead of the LIOB-Connect port as explained in Section 4.5.

### 5.1.3 LIOB-IP Device Mode (LIOB-45x/55x)

This mode is similar to the LIOB-FT device mode of LIOB-15x devices. The only difference is that the connection between the L-IOB host and the L-IOB devices is done over the LIOB-IP bus instead of the LIOB-FT port.

### 5.1.4 LONMARK® Device Mode (LIOB-15x/45x)

This is the standard device mode for LIOB-15x/45x devices. The L-IOB devices behave as independent nodes on a CEA-709 network. They are LONMARK® certified and support all current CEA-709 technologies such as the Enhanced Command Set (ECS) and a large number of network address table entries (512). A L-IOB host is not needed.

### 5.1.5 Non-ECS Device Mode (LIOB-15x/45x)

This mode is similar to the LONMARK® Device Mode with the exception that the Enhanced Command Set (ECS) is not supported and thus the L-IOB device only supports 15 address

table entries. This mode must be set when using network management tools which do not support ECS.

### 5.1.6 BACnet Device Mode (LIOB-55x)

This is the standard device mode for LIOB-55x devices. The L-IOB devices behave as independent nodes on a BACnet/IP network. A L-IOB host is not needed.

---

## 5.2 Device Installation

Depending on the device mode, device installation works as explained in the following sections.

### 5.2.1 Device Installation (LIOB-Connect device mode)

Whenever a new configuration is downloaded into a L-INX device (with connected LIOB-10x devices), as well as whenever the user manually scans for devices or starts a configuration run in the L-INX UI, the L-IOB devices are detected, commissioned, and configured. This is done in the following steps:

1. All L-IOB devices directly connected over the LIOB-Connect bus or over a LIOB-A2 adapter using a 4-wire cable (see Section 4.5) are detected. The devices are automatically enumerated according to their position in the physical daisy chain.
2. All devices are configured and set online. At this point, the L-IOB data points are available in the L-INX application.

### 5.2.2 Device Installation (LIOB-FT/IP device mode)

The first step after hardware installation is to setup the LIOB-FT/IP device mode, since LIOB-15x/45x/55x devices are in LONMARK® or BACnet device mode by default. See Section 6.4 for setting up the LIOB-FT/IP device mode in LIOB-15x/45x devices. See Section 6.1 for setting up the LIOB-IP device mode in LIOB-55x devices.

For LIOB-45x/55x devices in LIOB-IP device mode, the next step is the activation of the LIOB-IP channel in the L-IOB host, see Section 9.1. After that, the IP and host setup must be done in all LIOB-45x/55x devices, see Section 6.4 or Sections 7.2.4 and 7.2.7.

---

*Note:* Older L-IOB hosts must be upgraded to firmware version 4.8 or higher. After upgrading, the LIOB-IP support must be enabled in the Web-UI of the L-IOB host (menu "L-IOB / Upgrade")

---

For both LIOB-15x devices in LIOB-FT device mode and LIOB-45x/55x devices in LIOB-IP device mode, the user must then manually setup a unique Station-ID in each L-IOB device via the LCD UI (see Section 6.4). Alternatively, one can also setup the Node-IDs of all attached L-IOB devices in the L-IOB host's Web UI and start a configuration run (see Section 9.3). In this case, the L-IOB Station-IDs are automatically set by the L-IOB host during the configuration run.

Whenever a new configuration is downloaded into a L-IOB host (with connected LIOB-15x/45x/55x devices), as well as whenever the user manually scans for devices or starts a configuration run in the L-IOB host, the L-IOB devices are detected, commissioned, and configured. This is done in the following steps:

1. All L-IOB devices connected over the LIOB-FT/IP bus are detected. Enumeration is achieved via the Station-ID.

2. All devices are configured and set online. At this point, the L-IOB data points are available in the L-IOB host application.

### 5.2.3 Device Installation (LONMARK® / Non-ECS device mode)

For LIOB-45x devices in LONMARK® or Non-ECS device mode, the first step after hardware installation and IP setup is to add them to a CEA-852 channel, see Section 6.4 or Sections 7.2.4 and 7.2.8.

Both LIOB-15x and LIOB-45x devices in LONMARK® or Non-ECS device mode must then be installed and commissioned like any other CEA-709 / LONMARK® node. Please consult the documentation of your CEA-709 network management tool on how to perform these tasks.

For LNS™ based network management tools, the LOYTEC L-INX Configurator Software acts as an LNS™ plug-in to configure the L-IOB devices. It also installs the needed templates for all LIOB-15x/45x models when it is registered as a plug-in in the network management software. Both off- and online installation of the L-IOB devices is supported.

For Non- LNS™ network management tools, a LOYTEC NIC such as the NIC-USB100 or NIC852 is needed for configuration. The devices must be configured (using the CEA-709 Connection method of the Configurator Software) before installing and commissioning them in the network management tool. Afterwards, the device templates must always be created online from the L-IOB devices if the network management tool does not support changeable network variables. If the network management tool does support changeable network variables, the L-IOB devices can also be created from the corresponding L-IOB XIF files shipped with the L-INX Configurator software (folder 'XIF').

### 5.2.4 Device Installation (BACnet Mode)

Before the device can be used in the BACnet/IP network, the initial IP and BACnet setup must be done in the LCD UI (see Section 6.1) or Web UI (see Section 7.2).

---

## 5.3 Device Monitoring and Replacement

### 5.3.1 Device Monitoring and Replacement (L-INX Mode)

Whenever a L-IOB device loses communication with the L-IOB host, the host automatically detects the missing L-IOB and starts to poll the L-IOB device until it is detected again. Refer to Chapter 13 for more information on L-IOB device replacement.

### 5.3.2 Device Monitoring and Replacement (LONMARK® Mode)

Device monitoring and replacement works like with any other CEA-709 / LONMARK® node. Please consult the documentation of your CEA-709 network management tool on how to perform these tasks. If a device needs to be physically replaced (e.g. because it is defective), please use the 'replace' method of your network management tool. For Non-LNS™ based tools, either download the old configuration in the new device beforehand (using the CEA-709 Connection method of the Configurator Software) or use the restore function of the Configurator if you have a recent backup of the original L-IOB device available.

### 5.3.3 Device Replacement (BACnet Mode)

For replacing a LIOB-55x device, use the restore function of the Configurator (or LWEB-900 tool) with a recent backup of the original L-IOB device.



## 6 L-IOB LCD Display

The L-IOB device is equipped with an LCD display and jog dial for monitoring, testing, and configuration purposes. The LCD backlight is automatically switched off after 30 minutes of idle time (no jog dial or status button activity).

### 6.1 Main Page of LIOB-55x in BACnet Device Mode

The LCD main page of the LIOB-55x I/O modules in BACnet device mode is shown in Figure 31. It is different from the other I/O modules, since it is derived from the main page of the LIOB-58x I/O controller, see [2]. Observe that when in LIOB-IP device mode, the LIOB-55x has the same LCD UI as the LIOB-45x.

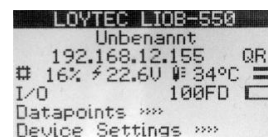

Figure 31: Main Screen of the LIOB-55x LCD in BACnet device mode

The main page displays (from top to bottom) the device name, project name, IP address, QR code menu item (shows QR code of IP address), CPU load, supply voltage, system temperature, language setting (flag symbol), local I/O menu, Ethernet connection status (e.g. “100FD” for single Ethernet devices or “Link12” for dual Ethernet devices), Ethernet traffic indicator, Datapoints menu and Device Settings menu. Observe that some settings require a reboot.

Turn the jog dial to navigate between menu items and press to enter a menu or go into selection mode. When in selection mode, turn the jog dial to alter the value and press again to quit the selection. The **I/O >>>** menu is described in Sections 6.2, 6.3, and 6.5. The **Datapoints >>>** menu allows browsing through the data points on the device.

The **Device Settings >>>** menu allows configuring basic device settings. Navigate e.g. to the **Device Management >>>** sub-menu, which is displayed in Figure 32.



Figure 32: Device Management Menu on the LIOB-55x LCD in BACnet device mode

This menu gives you e.g. the following options for basic device configuration:

- **TCP/IP Setup:** IP Configuration page (IP-Address, etc.).
- **Send ID messages:** send out an I-Am message.
- **Reboot system:** By choosing this item, the device performs a full reboot.
- **Clear DP config:** By choosing this item, the user can clear the device's entire data point configuration.
- **Factory Defaults:** By choosing this item, the user can reset the entire device to its factory default.
- **PIN:** Alter the default PIN to any 4-digit number to protect certain operations on the LCD UI. The user will be prompted to enter the PIN on protected areas.
- **Contrast:** changes the display contrast.
- **Language:** changes the LCD language. Observe that this requires a device reboot.
- **Reset I/O counters:** resets all I/O counters like pulse count values.
- **LIOB-IP Device Mode:** the LIOB-55x device switches to LIOB-IP device mode. Observe that changing the device mode will clear all configuration data except for the basic IP configuration.

## 6.2 Main Page of LIOB-10x/15x/45x (I/O Overview Page)

The main LCD page of the LIOB-10x/15x/45x models (and LIOB-55x in LIOB-IP device mode) is shown in Figure 33. The LIOB-55x models in BACnet device mode also contain this I/O overview page, but not as the main page. The top and bottom rows show the direction, state, and operating mode (without a letter = Auto, **M** = Manual, **O** = Override, **D** = Disabled) of all I/Os.



Figure 33: L-IOB LCD Display Main Page

The I/O state is shown as one of the following icons:

- **Switch Icon:** used for I/Os which generate a digital value as well as Inputs in Switch Mode,
- **Bar Icon:** used for I/Os which generate an analog value,
- **Pulse Icon:** used for pulse count inputs,
- **House Icon:** used for occupancy inputs,
- **Exclamation Mark:** shown for disconnected sensors or sensors which indicate an error,
- **Check Icon:** shown for sensors which indicate correct operation,

- **COM Icon:** used for all common terminals of relays and triacs.
- **CD Icon:** used for STId card reader code signals.
- **DT Icon:** used for STId card reader data signals.
- **CK Icon:** used for STId card reader clock signals.

Refer to Section 10.3 for details on I/O types, configuration, and operating modes.

When an I/O is selected, the middle part of the main page shows the I/O name, current value, terminal name, and terminal number. To the right, the device configuration icon (toothed wheel icon, see Section 6.4) and the device state icon is shown. When the device configuration icon is selected, the middle of the main page shows the device name, device state (offline, online, etc.), and station ID. The device state icon shows an exclamation mark if at least one I/O shows an exclamation mark. Otherwise it shows the checked icon to indicate that all I/Os are operating correctly. For LIOB-55x Models in BACnet device mode, the toothed wheel icon is replaced by an exit icon, which is used to exit the I/O overview page.

By turning the jog dial, the user can cycle through all I/Os (resp. to the device configuration icon, see Section 6.4). This can be used to get a quick overview of all I/O states as well as the device state. Observe that the common terminal icons (COM) only show the name and information of that terminal. No further configuration is possible for common terminals.

---

## 6.3 Manual / Quick Edit Mode

If the jog dial is pushed shortly on an I/O in manual mode (**M**), the quick edit mode is entered, which allows changing the I/O value by turning the jog dial. By pushing the jog dial shortly again, the quick edit mode is left. When pushing the jog dial shortly on an I/O in auto mode (normal mode without special letter), one can quickly switch to both manual mode *and* quick edit mode by turning to the jog dial. The manual mode (along with the quick edit mode) can be left again by pushing the jog dial for at least one second.

The manual mode can also be setup in the corresponding I/O configuration page (see Section 6.5) or for all I/Os in the device configuration page (see Section 6.4).

If an input is in manual mode, the physical input from the connected sensor is ignored and the user can setup a simulated input value to be used in the L-IOB host application or receiving node. This can be used e.g. to test the behavior of the application in the L-IOB host or receiving node depending on certain input values. If an output is in manual mode, the value coming from the L-IOB host or sending node is ignored and the user can set the value for the actuator connected to the physical output. This can be used to physically test the connected actuator.

It is possible that changing the manual value is restricted via a PIN code. In this case, the user will be requested to enter a pin code before the value can be changed. The pin code only needs to be entered once except when the device is not operated manually for more than 30 minutes.

---

## 6.4 Device Information and Configuration (LIOB-10x/15x/45x)

This page is available for the LIOB-10x/15x/45x models as well as the LIOB-55x models in LIOB-IP device mode. If the jog dial is pushed when the device configuration icon (toothed wheel icon to the right) is selected, the L-IOB device information and configuration page is entered, which allows viewing and changing device specific properties. If the jog dial is

pushed shortly on a device property, the edit mode is entered, which allows changing the property by turning the jog dial. By pushing the jog dial again, the edit mode is left. Following is a list of all device properties:

- **Remote LCD Access (L-INX Mode):** here the user can exit the remote LCD access. This option is only available if the L-IOB device is remotely accessed via the L-IOB host's LCD Display, see Section 8.2.
- **Pin Code Access:** here the user can explicitly log in and out with PIN code. This option is only available if a PIN code is set for the device.
- **Operating Mode:** here the user can change the operating mode of all I/Os except for disabled I/Os, which can only be changed via the I/O configuration page of that specific I/O.
- **Display Contrast:** here the user can setup the LCD display contrast.
- **DHCP, IP Address/Mask/Gateway (LIOB-45x/55x models):** here the user can configure the IP settings of the device. Observe that they must be confirmed with 'Save IP Settings' (see below).
- **IP Addr. LIOB Host (LIOB-IP device mode):** here the user can configure the IP address of the L-IOB host, the L-IOB device in LIOB-IP device mode shall be integrated with. Observe that NAT routers are not supported.
- **Config Server Addr. (LONMARK® Mode of LIOB-45x):** here the user can configure the IP Address of the CEA-852 Configuration Server, the LIOB-45x device in LONMARK® device mode shall become a member of. All further CEA-852 settings can be made in the L-IOB Web UI, see Section 7.2.8.
- **Save IP Settings (LIOB-45x/55x models):** here the user can confirm the IP settings. A device reboot will be performed automatically.
- **Ethernet Status (LIOB-45x/55x models):** shows the current Ethernet link status and connection speed.
- **Station ID (L-INX Mode):** shows the station ID (1-24) within the logical daisy chain of L-IOB devices on this L-IOB bus. For LIOB-FT/IP devices (LIOB-15x/45x/55x models), the user can edit this field to setup the order of L-IOB devices.
- **Configure (LIOB-FT/IP device mode):** here the user can request a fast device configuration or a complete bus configuration run (for all connected devices) from the L-IOB host. At the end of the configuration process, the L-IOB device will either be set online or an error message will be displayed (e.g. if no configuration is available for the requested station ID or the ID is already taken).
- **Domain Length, Domain, Subnet, Node, Set CEA709 Mode (LONMARK® Mode):** with these properties, the user can get a LIOB-15x/45x device online on a CEA-709 network without the need for a network management tool.
- **Device Name:** name of the L-IOB device.
- **Product Code:** L-IOB model (e.g. LIOB-100).
- **Device Status:** shows the current status of the L-IOB device (offline, online, in configuration, configured).

- **Firmware Image:** shows if the L-IOB device has booted the primary or fallback image (should always be primary).
- **Firmware Version:** version of L-IOB primary firmware image.
- **Firmware Build:** firmware build timestamp.
- **Serial Number:** serial number of the L-IOB device.
- **Node ID:** world-wide unique node ID of the L-IOB device.
- **CPU Load:** current CPU load on the L-IOB device.
- **System Temperature:** current L-IOB system temperature.
- **Supply Voltage:** current supply voltage of the L-IOB device.
- **Last Fatal Error:** shows the last detected fatal error.
- **Last Reset (L-INX Mode):** timestamp of last reset resp. power cycle of the L-IOB device. This is only set correctly if the L-IOB device is connected to a L-IOB host.
- **Current Date/Time:** shows the current date and time of the L-IOB. This is only set correctly if the L-IOB device is connected to a L-IOB host or time server.
- **Name of LIOB Host (L-INX Mode):** shows the name of the L-IOB host (e.g. L-INX device).
- **Host Project File (L-INX Mode):** shows the file name of the L-IOB host project.
- **Host Project Name (L-INX Mode):** shows the name of the L-IOB host project.
- **Host Project Date (L-INX Mode):** shows the creation date and time of the L-IOB host project.
- **Reset Count Values:** here the user can set back all count values (counting inputs and the run hours and energy count of all outputs).
- **Reset Device:** here the user can reset the device or set back the device to factory defaults. Observe that in the latter case, the device mode might change too.
- **Device Mode (LIOB-15x/45x/55x models):** here the user can change the device mode of a LIOB-15x/45x/55x device between LONMARK®, Non-ECS, LIOB-FT/IP, and BACnet (LIOB-55x). Observe that changing the device mode will clear all configuration data except for the basic IP configuration.
- **Model Number (LONMARK® Mode):** shows the model number (last byte of the Program ID) and version number of the corresponding XIF file.
- **Language:** here the user can setup the language (English or German) of the LCD display.

It is possible that changing the device configuration is restricted via a PIN code. In this case, the user will be requested to enter a pin code before a value can be changed. The pin code only needs to be entered once except when the device is not operated manually for more than 30 minutes or the user logs out explicitly.

## 6.5 I/O Configuration

If the jog dial is pushed for at least one second on any I/O, the configuration page for that I/O is entered, which allows viewing and changing configuration properties of the I/O. The properties which can be changed are enclosed by angle brackets (“<”, “>”). By turning the jog dial, the user can cycle through the configuration properties. If the jog dial is pushed shortly on a property, the edit mode is entered, which allows changing the property by turning the jog dial. By pushing the jog dial again, the edit mode is left.

It is possible that changing properties is restricted via a PIN code. In this case, the user will be requested to enter a pin code before a value can be changed. The pin code only needs to be entered once except when the device is not operated manually for more than 30 minutes.

To leave the configuration page, the user must turn the jog dial until the title line (I/O name) is selected and then push the jog dial. Alternatively, the jog dial can also be pushed anywhere on the page for at least 1 second.

Observe that depending on the hardware type, signal type, and interpretation of an I/O, the list of configuration properties varies. Refer to Section 10.3 for detailed information on the different configuration properties. In addition to the configuration properties described there, for some I/Os, a “RawValue” property will be displayed. It shows the physical measured value for inputs (e.g. the resistance of an NTC) resp. the physical value for outputs (e.g. the actual voltage for analog outputs). Note that this information can be used for debugging sensors or actuators but is not available in the form of data points on the LIOB host.

For counting inputs, two additional configuration options are available: ‘Pulse Count Reset’ and ‘Count Start Value’. Using ‘Pulse Count Reset’, the counter can either be reset to 0 or to the value set in ‘Count Start Value’.

# 7 L-IOB Web Interface (LIOB-45x/55x)

The LIOB-45x/55x models come with a built-in Web server and a Web interface to configure the device and extract statistics information. The Web interface allows configuring the IP settings, CEA-852, BACnet, and other settings.

---

## 7.1 Device Information and Account Management

In a Web browser, enter the default IP address 192.168.1.254 of the device. Note that if your PC has an IP address in a subnet other than 192.168.1.xxx, you must open a command tool and enter the following route command to add a route to the device.

### To Add a Route to the Device

1. Windows **START** → **Run**
2. Enter 'cmd' and click **OK**.
3. In the command window enter the command line

```
route add 192.168.1.254 %COMPUTERNAME%
```

In Windows 7 or Windows 8 replace %COMPUTERNAME% with the PC's actual IP address.

4. Then open your Web browser and type in the default IP address '192.168.1.254'.
5. The device information page should appear as shown in Figure 34.

The device information page shows information about the device and the current firmware version. Below, it shows operational parameters, such as free memory, CPU load, system temperature and supply voltage. The next part of the page shows the L-IOB device mode, device status, and host IP address (in L-INX mode).

The page also includes the unique node ID ("Neuron IDs") of the CEA-709 network interfaces. This page can also be used to send the CEA-709 service pin messages. This is a useful feature when commissioning the device (LONMARK® Mode), since it is not necessary to be on-site to press the status button.

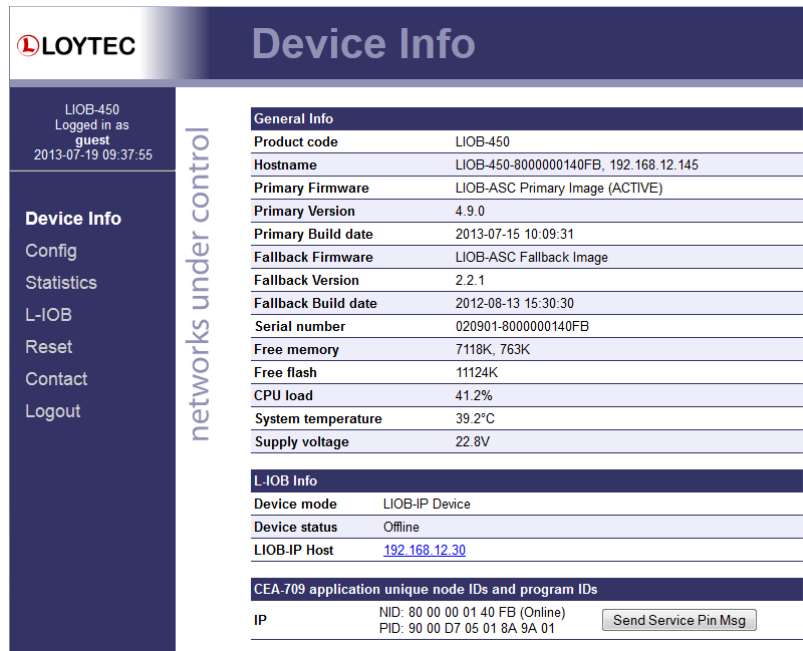

Figure 34: Device Information Page

Click through the menus on the left hand side to become familiar with the different screens. If you click on **Config** in the left menu, you will be asked to enter the administrator password in order to make changes to the settings as shown in Figure 35. Enter the default administrator password 'loytec4u' and select **Login**.

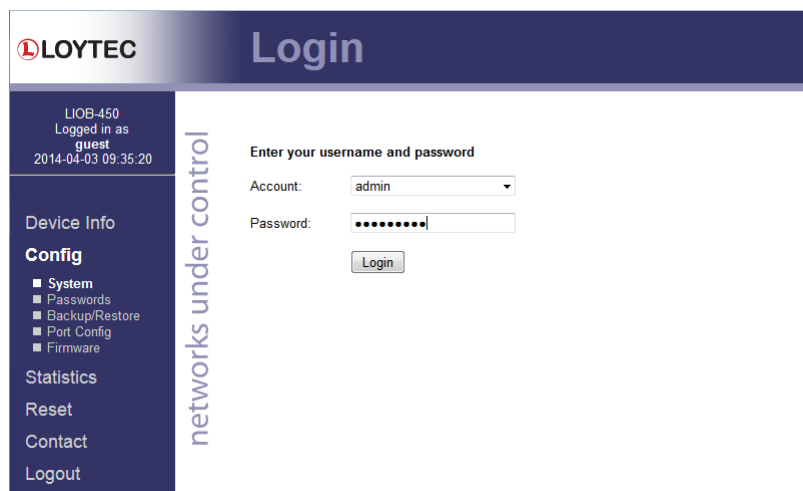

Figure 35: Enter 'loytec4u' as the default administrator password.

The Config menu opens. Click on **Passwords** in the Config menu, which opens the password configuration page as shown in Figure 36. The device has three user accounts: (1) **guest** allows the user to view certain information only, e.g., the device info page. By default the guest user has no password. (2) **operator** is able to read more sensible information such as calendar data. (3) **admin** has full access to the device and can make changes to its configuration. Note that the user accounts are also used to log on to the FTP and Telnet server.



Figure 36: Password Configuration Screen.

Please change the administrator password in order to protect yourself from unwanted configuration changes by anyone else. To do so, select the **admin** account in the drop-down box and enter the new password. If the administrator password is left empty, password protection is turned off and everyone can access the device without entering a password. Click on **Change password** to activate the change.

## 7.2 Device Configuration

The device configuration pages allow viewing and changing the device settings. Here are some general rules for setting IP addresses, port numbers, and time values:

- An empty IP address field disables the entry.
- An empty port number field sets the default port number.
- An empty time value field disables the time setting.

### 7.2.1 System Configuration

The system configuration page is shown in Figure 37. This page allows configuring the device's system time and other system settings. The **TCP/IP Configuration** link is a shortcut to the Ethernet port configuration. Follow that link to change the IP settings of the device.

The time sync source can be set to **auto**, **manual**, **NTP**, **BACnet** (LIOB-55x) or **LonMark** (LIOB-45x). In the **auto** mode, the device switches to the first external time source that is discovered. Possible external time sources are NTP, BACnet, or LonMark. The option **manual** allows setting the time manually in the fields **Local Time** and **Local Date**. In **manual** mode, the device does not switch to an external time source. Note, that if **NTP** is selected, the NTP servers have to be configured on the IP Configuration page (see Section 7.2.4).

In order to use BACnet as the time source, a BACnet device (time master) must be configured to distribute time synchronization. For doing so, the BACnet address of the devices, which shall be synchronized, must be added to the device object of the BACnet time master. The device synchronizes automatically as soon as it is contacted by the BACnet time master.

The time zone offset must be defined independently of the time source. It is specified as the offset to GMT in hours and minutes (e.g., Vienna/Austria is +01:00, New York/USA is -06:00). For setting the daylight saving time (DST) predefined choices are offered for

Europe and USA/Canada. DST can be switched off completely by choosing **none** or set manually for other regions. In that case, start and end date of DST must be entered in the fields below.

The screenshot shows the LOYTEC Config System interface. The top header includes the LOYTEC logo and the title 'Config System'. On the left, there is a navigation menu with options like 'Device Info', 'Config', 'Statistics', 'Reset', 'Contact', and 'Logout'. The main content area is titled 'networks under control' and contains several configuration sections:

- Date/Time:** Includes fields for Time sync source (set to 'auto'), Local Date (2014-04-03), Local Time (09:36:47), UTC Date/Time (2014-04-03 09:36:47), Timezone offset (00:00), Daylight saving time (DST) (set to 'None'), DST start (1st Su Jan 00:00), and DST end (1st Su Jan 00:00). Buttons for 'Save Date/Time' and 'Get Date/Time' are present.
- Earth Position:** Includes fields for Latitude (48° 13' 14" N), Longitude (16° 20' 05" E), and Altitude (200 m). Buttons for 'Save Earth Position' and 'Get Earth Position' are present.
- System Parameters:** Includes fields for Display units (set to 'Primary'), CSV delimiter (set to ','), and Automatic logout (checked). Buttons for 'Save System Parameters' and 'Get System Parameters' are present.
- Remote Configuration:** Includes a field for Request remote config (set to 'Disabled'). Buttons for 'Save Remote Config.' and 'Get Remote Config.' are present.

Figure 37: System Configuration Page, e.g., for Vienna, Austria.

The next section on the page allows configuring the device's earth position. This setting defines the longitude, latitude and elevation of the device. The latitude and longitude are entered as degrees, minutes, and seconds. The altitude is entered in meters height above sea level. This setting is used for an astronomical clock. For fixed locations such as a building, the position can be entered on this page.

For generating CSV files for trend logs, alarm logs, etc., the delimiter for those CSV files can be configured. This setting can be changed between a comma ',' and a semi-colon ';'. The change takes effect immediately for all files generated by the device.

For an automatic restore from LWEB-900, the 'Request remote config.' option must be enabled.

## 7.2.2 Backup and Restore

A configuration backup of the device can be downloaded via the Web interface. Press the backup link as shown in Figure 38 to start the download. The device assembles a single file including all required files. A file requestor dialog allows specifying the location where the backup file shall be stored.

To restore the device settings, simply select a previously generated backup file in the **Restore Configuration** section of the page by clicking the button next to the **Filename** field. Then press the **Restore** button.

The backed up configuration data consists of:

- Device settings (Passwords, IP settings, e-mail config, etc.),

- Data point configuration,
- CEA-709 binding information,
- BACnet server objects and client mappings,
- LIOB configuration and parameters,
- AST settings.

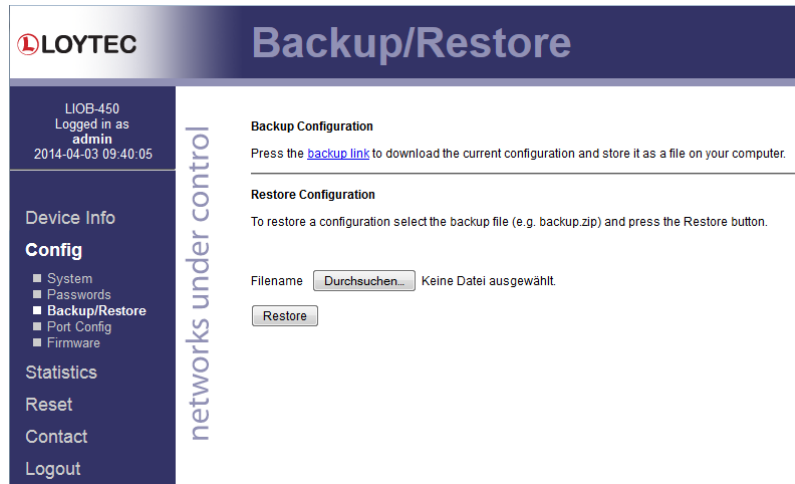

Figure 38: Backup/Restore page.

### 7.2.3 Port Configuration

This menu allows configuring the device's communications ports. For the Ethernet communication port, a configuration tab is provided by the Web UI, as shown in Figure 39.

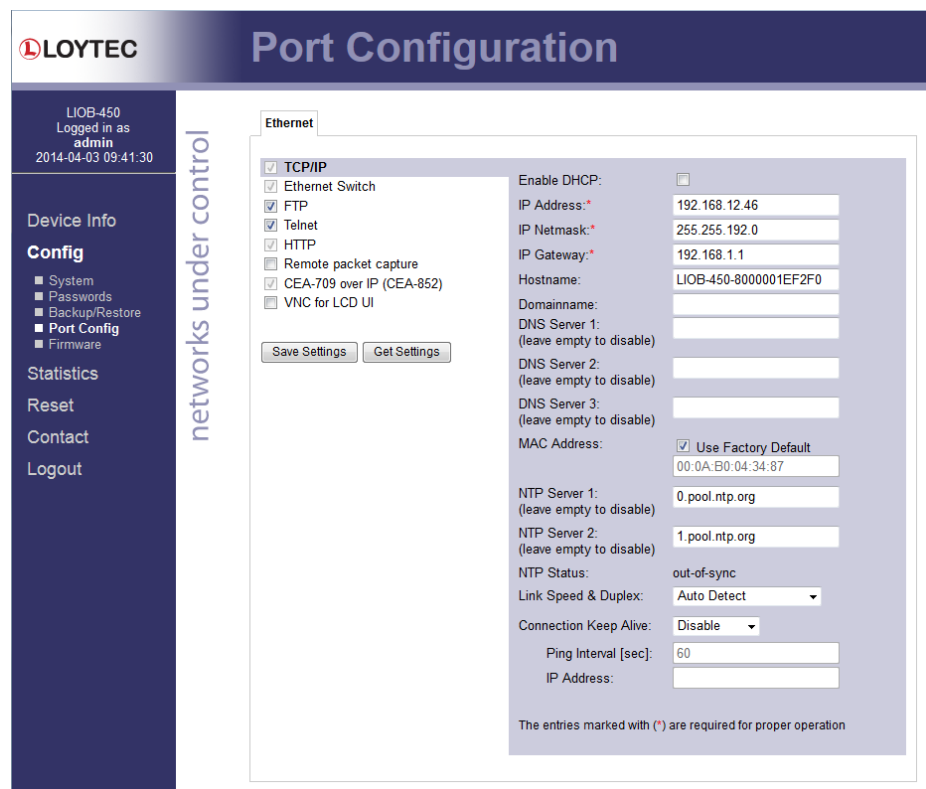

Figure 39: Port Configuration Page.

It contains a selection of available communication protocols. By selecting a checkbox or radio button the various protocols can be enabled or disabled on the communication port.

When selecting a protocol, the protocol's communication parameters are displayed in a box on the right-hand side. To save the settings of the currently opened protocol, click the **Save Settings** button. Pressing **Get Settings** retrieves the current settings from the device.

## 7.2.4 IP Configuration

The TCP/IP configuration is shown in Figure 39. The mandatory IP settings, which are needed to operate the device, are marked with a red asterisk (IP address, netmask, gateway). The **Enable DHCP** checkbox switches between manual entry of the IP address, netmask, and gateway address, and automatic configuration from a DHCP server.

**Hostname** and **Domainname** are optional entries and can be left empty. For some DHCP configurations it may be necessary to enter a hostname. Please contact your system administrator on how to configure DHCP to acquire an IP address. Further, you can configure up to 3 Domain Name Servers.

The device comes configured with a unique MAC address. This address can be changed in order to clone the MAC address of another device. Please contact your system administrator to avoid MAC address conflicts.

The device can be configured to synchronize its clock with NTP time. Enter the IP address of a primary and, optionally, a secondary NTP server. The device will use NTP as a time source if the time sync source in the system configuration page is set to **NTP** (see Section 7.2.1). The field **NTP status** below the NTP server settings displays the current NTP synchronization status (**out-of-sync**, or **in-sync**).

If the device is operated with a 10 Mbit/s-only hub, the link speed should be switched from **Auto Detect** to **10Mbps/Half-Duplex**. With modern 100/10 Mbit/s switches, this setting can be left at its default.

Other standard protocols that are bound to the Ethernet interface are FTP, Telnet, and HTTP (Web server). By deselecting the checkbox, those protocols can be individually disabled. The standard UDP/TCP ports can be changed in the respective protocol settings. An example for the FTP server is shown for FTP in Figure 40. The FTP server is used for instance to update the firmware. Note that HTTP for the Web server can only be disabled using the device configuration of the Configurator.

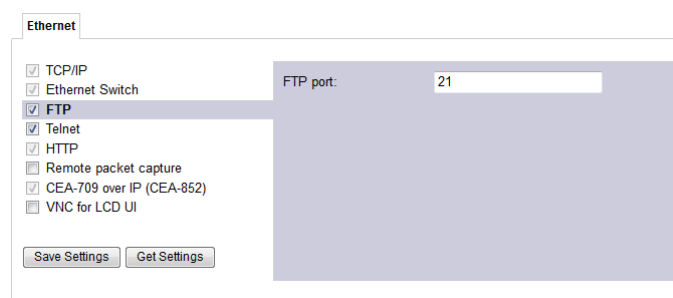

Figure 40: FTP server configuration on the Ethernet port.

## 7.2.5 Ethernet Switch

The L-IOB models, which provide a built-in Ethernet switch/hub, can configure the switch to forward traffic to one of the two ports. This allows connecting a laptop computer to the second Ethernet port and running a packet sniffer (e.g., Wireshark) on the device. To activate the sniffer mode, select the **Ethernet Switch** item as shown in Figure 41. In the

settings box select the Ethernet port, on which the network traffic shall be forwarded to (e.g., forward all traffic to Ethernet 2). Note that a reboot will reset this setting.

It is also possible to permanently disable any of the two Ethernet ports. This setting remains intact after a reboot.

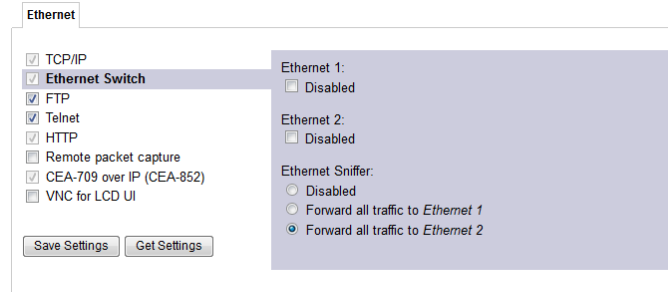

Figure 41: Activating the Ethernet Sniffer.

## 7.2.6 VNC Configuration

LIOB-45x/55x devices also provide remote access over Ethernet to the LCD display. The VNC protocol is used for this purpose and the device implements a VNC server for exposing the display. The VNC server is by default disabled on the device. On the PC a VNC client needs to be installed. Using the default settings, the VNC client connects to port 5900 of the device. The password is 'loytec4u'.

The VNC server can be configured on the **Ethernet** tab of the port configuration. To turn on the VNC server, enable the **VNC for LCD UI** checkbox. The VNC protocol settings are displayed in the settings box on the right-hand side as shown in Figure 42. The **VNC port** and **VNC password** can be changed. As a default, only one VNC client may connect. This limit may be increased in **Max VNC clients**. In order to protect changes made on the LCD UI over VNC with a PIN code, the **Admin PIN code** can be configured. To disable PIN protection, enter '0000'.

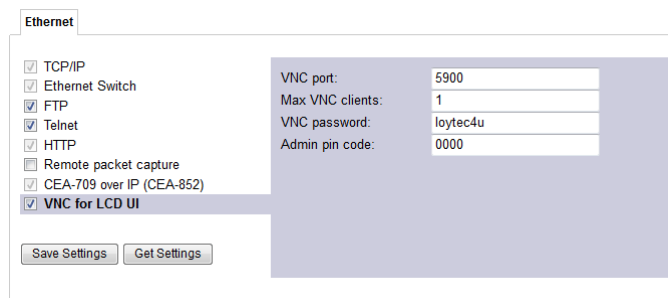

Figure 42: VNC Configuration.

## 7.2.7 LIOB-IP Configuration (LIOB-IP Device Mode)

As in the LCD UI (see Section 6.4), the IP Address of the L-IOB Host, which provides the LIOB-IP channel, can be setup here, see Figure 43. When the address is changed, the L-IOB device is automatically deleted from the old host and added to the LIOB-IP channel of the new host.

Protocol	Enabled
TCP/IP	<input checked="" type="checkbox"/>
Ethernet Switch	<input checked="" type="checkbox"/>
FTP	<input checked="" type="checkbox"/>
Telnet	<input checked="" type="checkbox"/>
HTTP	<input checked="" type="checkbox"/>
Remote packet capture	<input type="checkbox"/>
<b>LIOB-IP</b>	<input checked="" type="checkbox"/>
VNC for LCD UI	<input type="checkbox"/>

IP address of LIOB host:	192.168.12.30
Port of LIOB host:	16029
Local LIOB port:	1628
LIOB name:	

Figure 43: LIOB-IP Configuration.

## 7.2.8 CEA-852 Device Configuration (LONMARK® Mode)

For LIOB-45x devices in LONMARK® Mode, the **CEA-709 over IP (CEA-852)** protocol is enabled by default, since it is the only means to communicate in a control network. The CEA-852 protocol settings are displayed in the settings box on the right-hand side as shown in Figure 44. Typically, the device is added to an IP channel by entering the relevant information on a configuration server. The configuration server then contacts the CEA-852 unit of the L-IOB device and sends its configuration.

Protocol	Enabled
TCP/IP	<input checked="" type="checkbox"/>
Ethernet Switch	<input checked="" type="checkbox"/>
FTP	<input checked="" type="checkbox"/>
Telnet	<input checked="" type="checkbox"/>
HTTP	<input checked="" type="checkbox"/>
Remote packet capture	<input type="checkbox"/>
<b>CEA-709 over IP (CEA-852)</b>	<input checked="" type="checkbox"/>
VNC for LCD UI	<input type="checkbox"/>

Config server address:	192.168.12.30
Config server port:	1629
Config client port:	1628
Device name:	
Channel mode:	Standard
Pri. SNTP server:	<unset>
Sec. SNTP server:	<unset>
Channel timeout [ms]:	off
Escrow timeout [ms]: (leave empty to disable)	64
Aggregation timeout [ms]: (leave empty to disable)	16
MD5 authentication:	off
<small>Warning: This internet connection is insecure. All data will be transmitted in clear text. Use the console interface to change the MD5 secret in a secure way.</small>	
MD5 secret (16 bytes, hex)	
Location string	
NAT Address: (leave empty to disable)	<input checked="" type="checkbox"/> Automatic NAT
Multicast Address: (leave empty to disable)	

Figure 44: CEA-852 Device Configuration Page.

The field **Config server address** and **Config server port** display the IP address and port of the configuration server, which manages the L-IOB device and the IP channel. The field **Config client port** represents the IP port of the L-IOB's CEA-852 device. This setting should be left at its default (1628) unless there are more than one CEA-852 devices operating behind a single NAT router. Please refer to the L-IP User Manual to learn more about NAT configuration.

In the field **Device name** the user can enter a descriptive name for the L-IOB, which will appear in the IP channel to identify this device. You can enter a device name with up to 15 characters. It is recommended to use unique device names throughout the IP channel.

The **Channel mode** field reflects the current channel mode of the CEA-852 unit. It is configured by the configuration server. If there are any two devices in the channel which use the same IP address but different ports (e.g., multiple devices behind one NAT router) the channel switches to **Extended NAT mode**. Please refer to the L-IP User Manual to learn more about configuring the Extended NAT mode in the configuration server.

The configuration server sets the **SNTP server** addresses and the **Channel timeout**.

The field **Escrow timeout** defines how long the CEA-852 unit on the L-IOB waits for out-of-sequence CEA-852 data packets before they are discarded. Please enter the time in ms or '0' to disable escrowing. The maximum time is 255 ms.

The field **Aggregation timeout** defines the time interval in which multiple CEA-709 packets are combined into a single CEA-852 data packet. Please enter the time in ms or '0' to disable aggregation. The maximum time is 255 ms. Note that disabling aggregation will negatively affect the performance of the CEA-852 device of the L-IOB.

The field **MD5 authentication** enables or disables MD5 authentication. Note that MD5 authentication cannot be used together with the Echelon's *i.LON 1000* since the *i.LON 1000* is not fully compliant with the CEA-852 authentication method. MD5 can be used with the *i.LON 600*. In the following field **MD5 secret** enter the 16-byte MD5 secret. Note that for security purposes the active MD5 secret is not displayed. You may enter the 16 bytes as one string or with spaces between each byte, e.g., 00 11 22 33 44 55 66 77 88 99 AA BB CC DD EE FF.

Also note that entering the MD5 secret on the Web interface may pose a security risk. Since the information is transmitted over the network it can be subject for eavesdroppers on the line. It is recommended to use a cross-over cable.

In the field **Location string** the user can enter a descriptive text which identifies the physical location of the device. A location string can have a maximum length of 255 characters. This is optional and for informational purposes only.

If the CEA-852 unit on the L-IOB is used behind a NAT router, the public IP address of the NAT router or firewall must be known. To automatically detect the NAT address leave the **Auto-NAT** checkmark enabled.

The **Multicast Address** field allows the user to add the CEA-852 unit of the L-IOB into a multi-cast group for the CEA-852 IP channel. Enter the channel's IP multi-cast address here. Please contact your system administrator on how to obtain a valid multi-cast address. To learn when it is beneficial to use multi-cast addresses in your channel please refer to the L-IP User Manual.

### 7.2.9 BACnet Configuration (BACnet Mode)

Figure 45 shows the BACnet device configuration page of a LIOB-55x in BACnet Mode. This configuration page allows setting the **Device ID**, which is the instance part of the Object\_Identifier property of the BACnet Device object. The field **Device name** holds the name of the BACnet device object (property Object\_Name).

---

**Important!**      *The device ID and device name must be unique within the BACnet inter-network.*

---

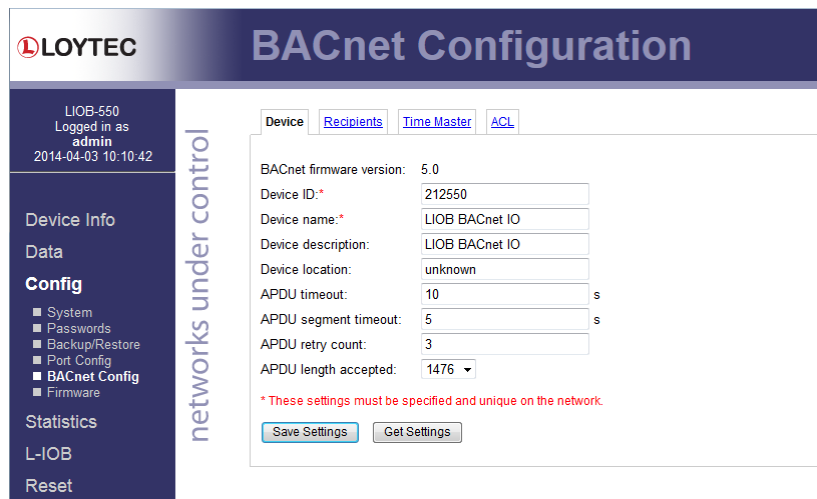

Figure 45: BACnet Device Configuration

Further, the description and location can be configured. These configuration items correspond to the properties Description, and Location respectively of the BACnet Device object. For tuning BACnet application timing parameters, set **APDU timeout**, **APDU segment timeout**, and **APDU retry count**. The timeout values are entered in seconds allowing decimal notation, e.g. "7.5".

---

*Note:* If this page displays the message "Device communication is disabled via BACnet network!" the device has been externally disabled. Reboot the device to activate communication again.

---

### 7.2.10 BACnet/IP Configuration (BACnet Mode)

For LIOB-55x devices in BACnet Mode, the **BACnet/IP** protocol is enabled by default, since it is the only means to communicate in a control network. The protocol is available on the Ethernet port. The BACnet/IP protocol settings are displayed in the settings box on the right-hand side as shown in Figure 46. If the BACnet/IP network uses a non-default UDP port number other than 47808/0xBAC0, enter this port in the **BACnet/IP port** field. Enter '0' in this field for switching back to the default setting.

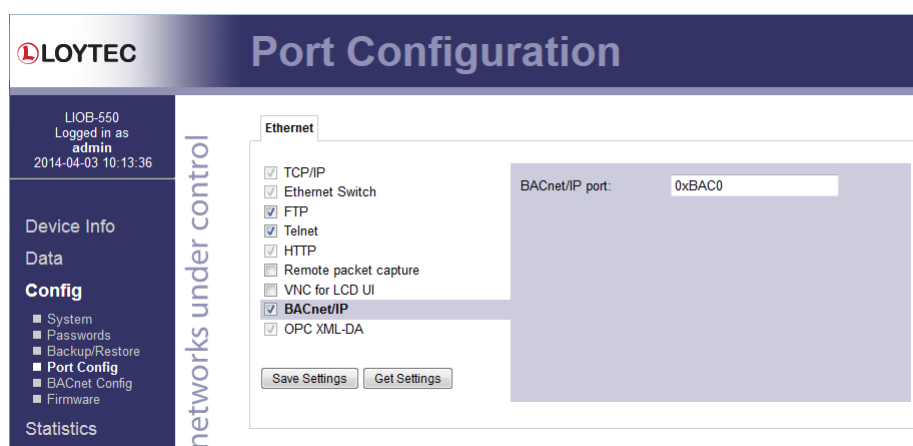

Figure 46: BACnet/IP Configuration

### 7.2.11 Data Points and AST (BACnet Mode)

The LIOB-55x I/O modules in BACnet Mode support internal, technology independent data points as well as alarming, scheduling, and trending (AST) similar to the LIOB I/O



controllers. The corresponding Web UI device configuration items are located in the main menu 'Data' and are named 'Data Points', 'Trend', 'Scheduler', 'Calendar', and 'Alarm'. Since the main purpose of LIOB I/O modules is to directly expose I/Os to the control network (CEA-852 or BACnet/IP), these function will usually not be required. For more information on technology independent data points and AST, please refer to the L-INX user manual [1] or LIOB-x8x user manual [2].

## 7.2.12 Firmware

The firmware page allows upgrading the device's firmware over the Web interface. It offers two options:

- **Web Update:** With Web update the device searches for the latest available firmware on the LOYTEC server. Click on the refresh symbol, if no latest version is displayed. Please note, that the device must have a DNS server configured to find the LOYTEC server. Click on the **Install** button to upgrade your device.
- **Local file:** Update the device from a local disk file. For doing so, choose a .dl file on you hard drive and then click on the **Start Update** button.



Figure 47: Firmware upgrade over the Web interface.

## 7.3 Device Statistics

The device statistics pages provide advanced statistics information about the CEA-709 device, the CEA-852 device, the system log, and the Ethernet interface.

### 7.3.1 System Log

The System Log page prints all messages stored in the system log of the device. An example is shown in Figure 48. This log data is important for trouble-shooting. It contains log entries for reboots and abnormal operating conditions. When contacting LOYTEC support, please have a copy of this log ready.

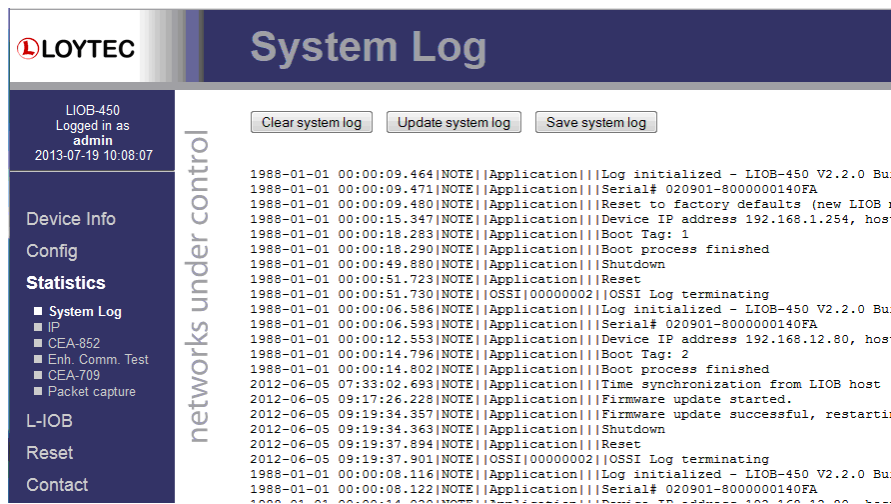

Figure 48: System Log Page.

### 7.3.2 IP Statistics

Figure 49 shows the IP statistics page. It allows finding possible problems related to the IP communication. Specifically, any detected IP address conflicts are displayed (if the device’s IP address conflicts with a different device on the network).

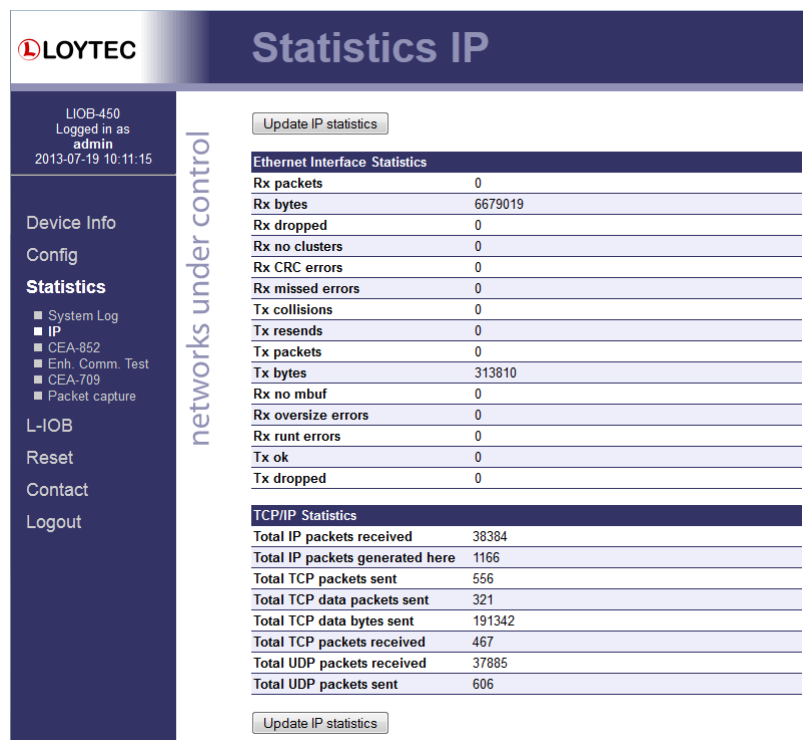

Figure 49: IP Statistics Page.

### 7.3.3 CEA-852 Statistics (LIOB-IP or LONMARK® Mode)

The CEA-852 statistics page displays the statistics data of the CEA-852 unit on the device. The upper part of the CEA-852 statistics page is depicted in Figure 50. To update the statistics data, press the button **Update all CEA-852 statistics**. To reset all statistics counters to zero, click on the button **Clear all CEA-852 statistics**. The field **Date/Time of clear** will reflect the time of the last counter reset.

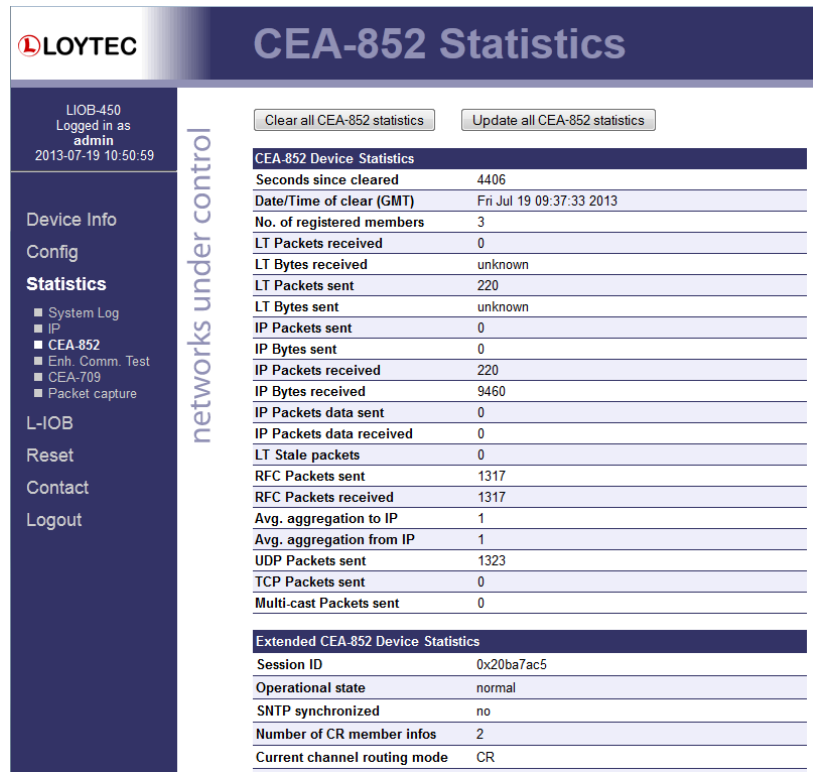

Figure 50: Part of the CEA-852 Statistics Page.

### 7.3.4 Enhanced Communications Test (LIOB-IP or LONMARK® Mode)

The Enhanced Communications Test allows testing the CEA-852 communication path between the CEA-852 unit on the L-IOB device and other CEA-852 devices as well as the configuration server. The test thoroughly diagnoses the paths between individual members of the IP channel and the configuration server in each direction. Port-forwarding problems are recognized. For older devices or devices by other manufacturers, which do not support the enhanced test features, the test passes as soon as a device is reachable, but adds a comment, that the return path could not be tested. A typical output is shown in Figure 51.

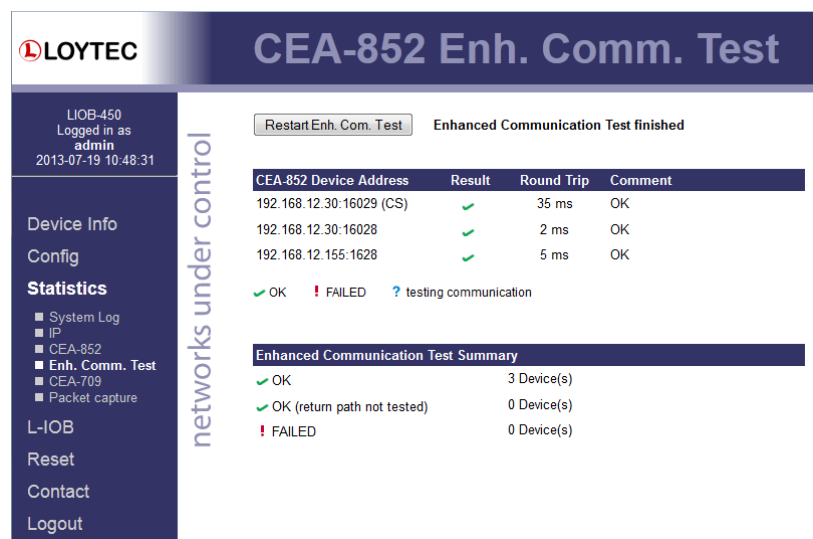

Figure 51: Enhanced Communication Test Output.

The Round Trip Time (RTT) is measured as the time a packet sent to the peer device needs to be routed back to the device. It is a measure for general network delay. If the test to a

specific member fails, a text is displayed to describe the possible source of the problem. The reasons for failure are summarized in Table 4.

Text displayed (Web icon)	Meaning
OK, Return path not tested (green checkmark)	Displayed for a device which is reachable but which does not support the feature to test the return path (device sending to this CEA-852 device). Therefore a potential NAT router configuration error cannot be detected. If the tested device is an L-IP, it is recommended to upgrade this L-IP to 3.0 or higher.
Not reachable/not supported (red exclamation)	This is displayed for the CS if it is not reachable or the CS does not support this test. To remove this uncertainty it is recommended to upgrade the L-IP to 3.0 or higher.
Local NAT config. Error (red exclamation)	This is displayed if the CEA-852 device is located behind a NAT router or firewall, and the port-forwarding in the NAT-Router (usually 1628) or the filter table of the firewall is incorrect.
Peer not reachable (red exclamation)	Displayed for a device, if it is not reachable. No RTT is displayed. The device is either not online, not connected to the network, has no IP address, or is not reachable behind its NAT router. Execute this test on the suspicious device to determine any NAT configuration problem.

Table 4: Possible Communication Problems.

### 7.3.5 CEA-709 Statistics (LIQB-IP or LonMARK® Mode)

The CEA-709 statistics page displays statistics data of the CEA-709 port on the device as shown in Figure 52. This data can be used to troubleshoot networking problems. To update the data, click on the button **Update CEA-709 statistics**.

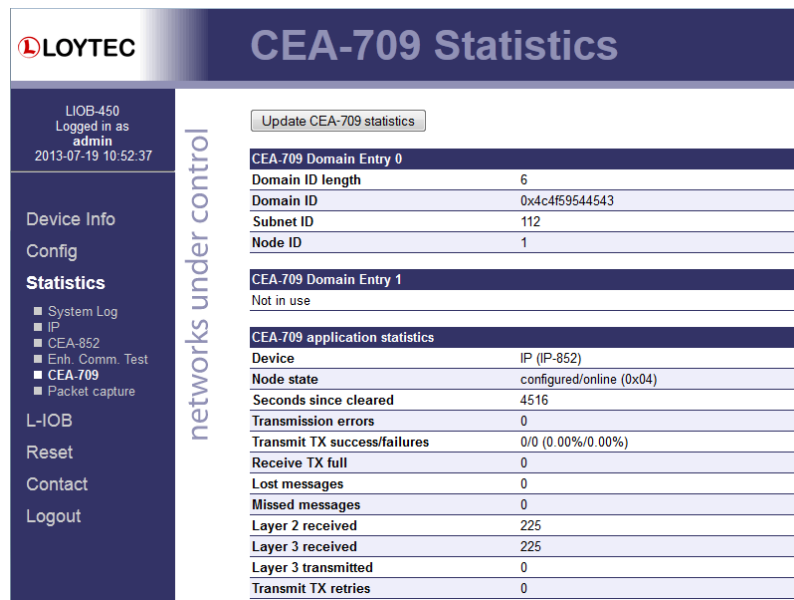
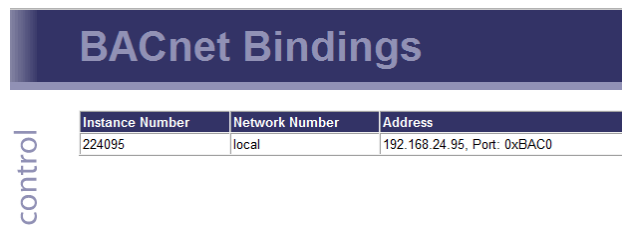

Figure 52: CEA-709 Statistics Page.

### 7.3.6 BACnet Bindings Statistics (BACnet Mode)

The BACnet bindings statistics page displays a list of all currently active address bindings. This list can be used for troubleshooting to see, which BACnet device instance numbers could be resolved and to what BACnet network number and MAC address. See Figure 53 for an example list. In this case the device instance 224095 has been resolved to the local network and MAC address 192.168.24.95:BAC0.



Instance Number	Network Number	Address
224095	local	192.168.24.95, Port: 0xBAC0

Figure 53: BACnet bindings statistics page

### 7.3.7 Scheduler and Alarm Log Statistics (BACnet Mode)

The LIOB-55x I/O modules in BACnet Mode support scheduling and alarming similar to the LIOB I/O controllers. The corresponding Web UI statistics items are named ‘Scheduler’ and ‘Alarm Log’. Since the main purpose of LIOB I/O modules is to directly expose I/Os to the control network (CEA-852 or BACnet/IP), these function will usually not be required. For more information on scheduling and alarming, please refer to the L-INX user manual [1] or LIOB-x8x user manual [2].

---

## 7.4 L-IOB Page (L-INX Mode)

This page just provides a link to the I/O overview page of the L-IOB host (see Section 9.5), since the L-IOB device itself does not have such an I/O overview page.

---

## 7.5 Reset, Contact, Logout

- The menu item **Reset** allows rebooting the device from a remote location.
- The **Contact** item provides contact information and a link to the latest user manual and the latest firmware version.
- The **Logout** item closes the current session.

# 8 L-IOB Host LCD Display (L-INX Mode)

This chapter only applies to LIOB-10x models, LIOB-15x models in LIOB-FT device mode, and LIOB-45x/55x models in LIOB-IP device mode.

The L-IOB host (L-INX or LIOB-48x/58x) provides an LCD interface to configure, operate, and test the connected L-IOB devices. Refer to the L-INX user manual [1] for general information on the L-INX LCD interface. Refer to the LIOB-x8x user manual [2] for general information on the LIOB-48x/58x LCD interface.

---

## 8.1 L-IOB Scan and Configuration Run

Even without any configuration, the L-IOB bus can be scanned to check which L-IOB devices are connected to the L-IOB host. In the menu **Device Settings** »» **LIOB** »», **LIOB-FT** »», or **LIOB-IP** »», select the item **Scan LIOB bus** to scan for attached L-IOB devices. During the scan process, the status of the currently configured L-IOB device is shown in the LCD. At the end, the LCD will show all detected L-IOB devices and their status resp. error state. By pushing the jog dial on a certain L-IOB device, some configuration properties of the device are displayed. Refer to Section 10.2 for information on these properties.

If a configuration is downloaded to the L-IOB host using the Configurator software (see Chapter 11), a configuration run is started automatically and if the configuration matches the physically attached L-IOB devices, all L-IOB devices should go online. The configuration run can also be started manually at any time by selecting **Configure LIOBs** in the menu **Device Settings** »» **LIOB** »», **LIOB-FT** »», or **LIOB-IP** »». This is required e.g. when a L-IOB device is replaced without power-cycling the L-IOB host, see Section 13.1.2.

L-IOB Devices can be enabled and disabled by pushing the jog dial on the corresponding device in **Device Settings** »» **LIOB** »», **LIOB-FT** »», or **LIOB-IP** »» and choosing **Enable** or **Disable**. To activate the new setting, a configuration run must be started afterwards by choosing **Configure LIOBs** as described above.

---

## 8.2 L-IOB Remote Access

The LCD Display of a connected L-IOB device can be remotely accessed by pushing the jog dial on the corresponding device in menu **Device Settings** »» **LIOB** »», **LIOB-FT** »», or **LIOB-IP** »» and choosing **Remote Display**. To leave the remote display mode again, either push and hold the jog dial for at least 10s and then release it or exit via the **Remote LCD Access** menu item in the device configuration page of the L-IOB device (see Section 6.4).

### 8.3 L-IOB Data Points

The L-IOB data points can be accessed in the menus **Datapoints** »» **LIOB** »», **LIOB-FT** »», and **LIOB-IP** »». Please refer to Section 10.6 for a detailed description of all L-IOB data points at bus, device, and I/O level.

# 9 L-IOB Host Web Interface (L-INX Mode)

This chapter only applies to LIOB-10x models, LIOB-15x models in LIOB-FT device mode, and LIOB-45x/55x models in LIOB-IP device mode.

The L-IOB host (L-INX or LIOB-48x/58x) provides a Web interface to configure, operate, and test the connected L-IOB devices. It also provides statistics information about the L-IOBs. Refer to the L-INX user manual [1] for general information on the L-INX Web interface. Refer to the LIOB-x8x user manual [2] for general information on the LIOB-48x/58x Web interface.

## 9.1 LIOB-IP Bus (for LIOB-45x/55x)

To be able to connect LIOB-45x/55x devices over the LIOB-IP bus, the firmware version of the L-IOB host must be 4.8 or higher.

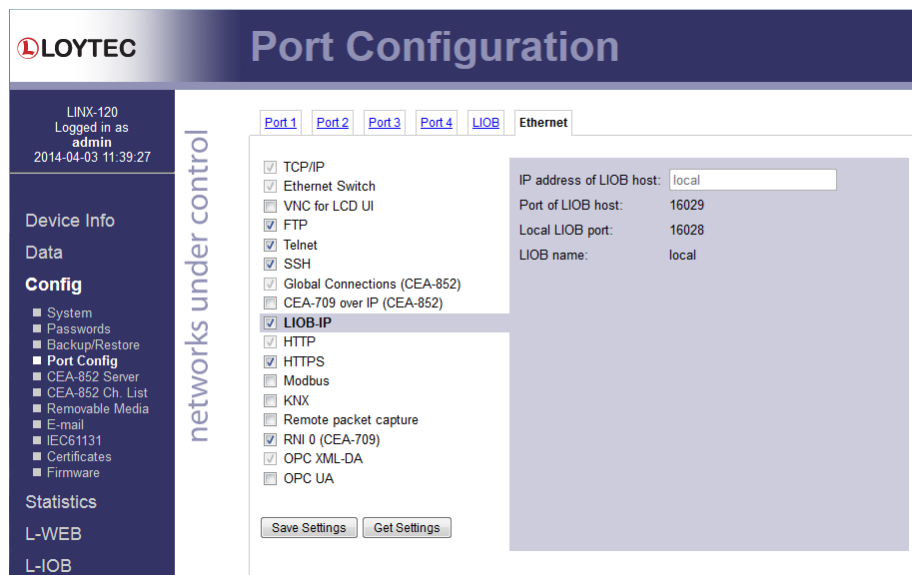

Figure 54: LIOB-IP Bus

After a firmware upgrade, the LIOB-IP support must be enabled in the Web-UI (menu “L-IOB / Upgrade”). The LIOB-IP bus will then be enabled by default, as shown in Figure 54. It is possible to disable the LIOB-IP bus entirely by un-checking the **LIOB-IP** checkbox. The corresponding UDP/TCP ports 16028 and 16029 will then not be open



anymore on the L-IOB host. Observe that the LIOB-IP bus only acts as a virtual medium, connecting the L-IOB host with the LIOB-45x/55x devices over Ethernet/IP. The rest of the configuration (device enumeration, etc.) must still be done as for LIOB-15x devices, see Section 9.3.

## 9.2 L-IOB Installation Page (LIOB-Connect Bus)

The **LIOB Installation** page for the LIOB-Connect bus without a configuration is shown in Figure 55.

LIOB Type	Name	Node ID	Status	Enable
1	LIOB-100	80:00:00:0E:1C:20	Not configured	
2	LIOB-100	80:00:00:0E:1C:73	Not configured	
3	LIOB-100	80:00:00:0E:1C:69	Not configured	
4	LIOB-101	80:00:00:0D:28:D5	Not configured	
5	LIOB-101	80:00:00:0D:28:8A	Not configured	
6	No LIOB device present			
7	No LIOB device present			
8	No LIOB device present			
9	No LIOB device present			
10	No LIOB device present			
11	No LIOB device present			
12	No LIOB device present			
13	No LIOB device present			
14	No LIOB device present			
15	No LIOB device present			
16	No LIOB device present			
17	No LIOB device present			
18	No LIOB device present			
19	No LIOB device present			
20	No LIOB device present			
21	No LIOB device present			
22	No LIOB device present			
23	No LIOB device present			
24	No LIOB device present			

Figure 55: LIOB-Connect Device Installation and Scan

### 9.2.1 L-IOB Scan and Configuration Run

Even without any configuration, the L-IOB bus can be scanned to check which L-IOB devices are connected to the L-IOB host. This can be done by clicking **Scan**. During the scan process, the status of the connected L-IOB devices is shown in the web page. At the end, the page should e.g. look like Figure 55. In this case, 3 LIOB-100 devices and two LIOB-101 devices have been found. For all shown L-IOB devices, the **Name** is blank and the **Status** is “**Not configured**” since the L-IOB host does not have a configuration downloaded yet.

If a configuration is downloaded to the L-IOB host using the Configurator software (see Chapter 11), a configuration run is started automatically and, if the configuration matches the physically attached L-IOB devices, all L-IOB devices should go online. The configuration run can also be started manually at any time by clicking **Save Settings**. This is required e.g. when a L-IOB device is replaced without power-cycling the L-IOB host, see Section 13.1.2. Figure 56 shows the LIOB installation page after clicking **Save Settings**.

Figure 56: LIOB Configuration Run

The LIOB Installation page will also show configuration errors. In Figure 57 e.g. the last L-IOB device could not be detected.

Figure 57: Missing L-IOB Device

This could be caused by a communication problem or by a physically missing L-IOB device. In case it is OK that this device is missing, it must be disabled in the Web UI by un-checking the corresponding **Enable** checkbox and clicking **Save Settings** again, see Figure 58.



Figure 58: Disabled L-IOB Device

### 9.3 L-IOB Installation Page (LIOB-FT/IP Bus)

The **LIOB Installation** page for the LIOB-FT or LIOB-IP bus is shown in Figure 59. It works similar to the Installation page of the LIOB-Connect bus with a few differences:

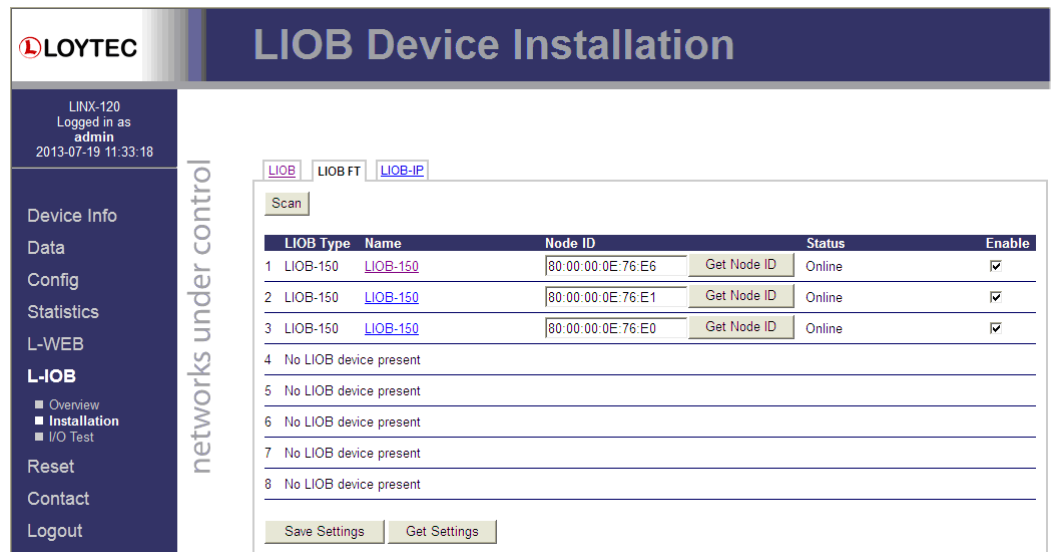

Figure 59: LIOB-FT/IP Device Installation and Scan

Since the LIOB-FT/IP bus does not have a mechanism to automatically enumerate connected L-IOB devices, the user must determine the order manually. This is done either by setting the Station IDs in the LCD UI of the L-IOB devices (see Section 6.4) or by entering the Node IDs of the connected L-IOBs as shown in Figure 59 and clicking **Save Settings**. By clicking **Scan**, the order as currently configured in the L-IOB devices will be detected and displayed. The Node IDs can also be setup by clicking **Get Node ID** and then pressing the status button (see Section 4.6.3) of the corresponding L-IOB device. Whenever changes have been made in the Web UI, in the end the **Save Settings** button must be clicked to configure the connected L-IOB devices accordingly.

## 9.4 L-IOB Device Information and Statistics

By clicking on one of the L-IOB device links in the **Name** column of the LIOB Installation page, the L-IOB device information and statistics page can be shown for that device, see Figure 60. Using the buttons **Reboot device** and **Reset to factory defaults**, the L-IOB device can be rebooted or reset to factory defaults.

The **Device information** part shows device specific configuration properties (see Section 10.2) and some live values of the device (CPU load, System temperature & voltage). The system log of the L-IOB device can be displayed by clicking on **system log**.

The **LIOB communication statistics** part shows statistics information of the communication bus. These values are mainly used for support and debugging.

Device information		Reload
Product code	LIOB-100	
Device name	LIOB1	
Pin code	0000	Save
Firmware version	4.9.0.0	
Build date	2013-07-15 06:58:01	
Serial number	014502-8000000E1C80	
Node ID	80:00:00:0E:1C:80	
CPU load	33.4%	
System temperature	38.4°C	
Supply voltage	22.7V	
Last reset	2013-07-17 08:01:19	
Status	Online, View <a href="#">system log</a>	

LIOB communication statistics		Update statistics
Seconds since cleared	44	
Transmission errors	0	
Transmit TX success/failures	1509/0 (100.00%/0.00%)	
Receive TX full	0	
Lost messages	0	
Missed messages	0	
Layer 2 received	16226	
Layer 3 received	16226	
Layer 3 transmitted	38886	
Transmit TX retries	0	
Backlog overflows	611	
Late acknowledgments	0	
Collisions	0	
Out buffers used	0	
In buffers used	0	
TCL active	0/1	
TSPs used	1	
TSPs deleted	0	

Figure 60: L-IOB Device Information and Statistics

Observe that if the L-IOB device is unconfigured (not part of the L-IOB host configuration), the LIOB communication statistics table as well as some information in the Device information table cannot be displayed.

## 9.5 L-IOB Overview Page

The **LIOB Overview** page provides a quick overview of all L-IOB devices and their I/Os. This page is also available for the local I/Os of a L-IOB host (LIOB-48x/58x). Figure 61 shows the Overview page for the first L-IOB device of a LIOB-Connect bus. With **Reset All Count Values**, the counter inputs as well as the run hours and energy count values of all outputs can be reset. This can also be done for each L-IOB device individually by clicking the **Reset Count Values** button of the device.

networks under control

LIQB | [LIQB-FT](#) | [LIQB-IP](#)

Reload | Reset All Count Values

I/O Name	Term	Type	Value	Mode	Status
<b>LIQB1 (Online)</b>	Reload	Reset Count Values			
<a href="#">UI_Custom_NTC</a>	UI1	IN Analog/Digital 10V	25.30 °C	Auto	OK
<a href="#">UI_PT1000</a>	UI2	IN Analog/Digital 10V	-1.12 °C	Auto	OK
<a href="#">UI_NTC10K</a>	UI3	IN Analog/Digital 10V	20.22 °C	Auto	OK
<a href="#">UI_NTC1KΩ</a>	UI4	IN Analog/Digital 10V	25.23 °C	Auto	OK
<a href="#">UI_Ni1000</a>	UI5	IN Analog/Digital 10V	-2.03 °C	Auto	OK
<a href="#">UI_Linear</a>	UI6	IN Analog/Digital 10V	28.85 °C	Auto	OK
<a href="#">UI_Frequency</a>	UI7	IN Analog/Digital 10V	0.00 Hz	Auto	OK
<a href="#">UI_Trans_Table</a>	UI8	IN Analog/Digital 10V	39.96 °C	Auto	OK
<a href="#">DI_Digital</a>	DI1	IN Digital	OPEN	Auto	OK
<a href="#">DI_Pulse_Cnt</a>	DI2	IN Digital	0.00	Auto	OK
<a href="#">AO_Digital</a>	AO1	OUT Analog 12V	OFF	Auto	OK
<a href="#">AO_Analog</a>	AO2	OUT Analog 12V	0.00 V	Auto	OK
<a href="#">DO_Digital</a>	DO1	OUT Relais 6A	OPEN	Auto	OK
<a href="#">DO_PWM</a>	DO2	OUT Relais 6A	0.00 %	Auto	OK
<a href="#">manual</a>	DO3	OUT Relais 6A	OPEN	Manual	OK
<a href="#">override</a>	DO4	OUT Relais 6A	OPEN	Override	OK
<a href="#">disabled</a>	DO5	OUT Relais 6A	OPEN	Disabled	OK
<a href="#">unused</a>	DO6	OUT Triac	OPEN	Auto	OK
<a href="#">unused</a>	DO7	OUT Triac	OPEN	Auto	OK

Figure 61: LIOB Overview

Further L-IOB devices can be displayed by scrolling down. The live value and a few properties are shown for each I/O of the L-IOB devices. The operating mode of each I/O can be changed in the **Mode** column. The **Value** column always shows the corresponding effective value (e.g. the override value in override mode). In case of manual operating mode (see Section 10.3.11), the manual value is displayed and can be changed in the **Value** column.

By clicking on the link in the **I/O Name** column, a detailed view of each I/O can be invoked, see Figure 62. Please refer to Section 10.3 for a detailed description of all I/O properties. After changing configuration properties, the user must click **Save Settings** to activate the new configuration in the L-IOB device.

LIOB1, Terminal UI1	
Name	UI1
Input	0.08 V
HardwareType	IN Analog/Digital
SignalType	Voltage 0-10V
Interpretation	Linear
OperatingMode	Auto
AnalInvert	<input type="checkbox"/>
Sqrt	<input type="checkbox"/>
SIUnit_OnText	V
USUnit_OffText	V
Resolution	0.10 V
MultUS	1.00
OffsUS	0.00
OverrideValue	0.00 V
DefaultValue	0.00 V
Offset	0.00 V
MinValue	0.00 V
MaxValue	10.00 V
COV	0.10 V
MinSendTime	0.00 s
MaxSendTime	10.00 s
IOStatus	OK
ManualValue	0.00 V

Figure 62: L-IOB I/O Details

## 9.6 L-IOB I/O Test Page

The **LIOB I/O Test** page provides the possibility of documenting tests of the connected actuators and sensors. This page is available for all L-IOB devices connected to the L-IOB host as well as the local I/Os of the host (LIOB-48x/58x). Figure 63 shows the L-IOB I/O test page of a connected L-IOB device.

# LIOB I/O Test

networks under control

LIOB
LIOB-FT
LIOB-IP

I/O Name	Terminal	Test Result	Test Date	Test Comment
LIOB1 (Offline)				
UI_Custom_NTC	UI1	Not Tested	2012-12-13 22:43:15	No sensor available yet
UI_PT1000	UI2	Not Tested	2012-12-13 22:43:19	No sensor available yet
UI_NTC10K	UI3	OK	2012-12-13 22:43:22	Was tested with actual sensor
UI_NTC1K8	UI4	OK	2012-12-13 22:43:26	Was tested with actual sensor
UI_Ni1000	UI5	OK	2012-12-13 22:43:28	Was tested with actual sensor
UI_Linear	UI6	Not Tested	2012-12-13 22:43:31	No sensor available yet
UI_Frequency	UI7	NOT OK	2012-12-13 22:43:35	Sensor defect

Figure 63: L-IOB I/O Test

For each I/O, a **Test Result** (Not Tested, OK, NOT OK) can be chosen. The **Test Date** will then be set automatically but can be manually changed afterwards. An additional **Test Comment** can be entered. This data will be stored persistently in the L-IOB host until it is explicitly cleared or the type of the connected L-IOB device changes because of a new host

configuration. To explicitly clear the test information, the buttons **Clear Tests** or **Clear All Tests** are used. The test information can also be exported to a CSV file by using **Export Device (CSV)** or **Export All (CSV)**.

## 9.7 L-IOB Data Points

The L-IOB data points are located in the folders **LIOB**, **LIOB-FT**, and **LIOB-IP** of the L-IOB host data points. Figure 64 e.g. shows the data points of the first I/O of LIOB1. Please refer to Section 10.6 for a detailed description of all L-IOB data points at bus, device, and I/O level.

The screenshot shows the LOYTEC Data Points web interface. On the left is a navigation menu with options like Device Info, Data, Config, Statistics, L-WEB, L-IOB, ekey, Reset, Contact, and Logout. The main area displays a tree view of data points under the heading 'networks under control'. The tree is expanded to show the 'LIOB-100\_1' folder, which contains a sub-folder 'UI1 (Custom\_NTC)'. Below the tree, a table lists the data points for UI1.

Name	Dir.	Type	State	Value
L1_1_UI1_Input	input	analog	normal	25.08807 °C
L1_1_UI1_IOStatus	input	multistate	normal	OK
L1_1_UI1_ManualValue	value	analog	normal	0 °C
L1_1_UI1_OperatingMode	value	multistate	normal	Auto
L1_1_UI1_OverrideValue	value	analog	normal	0 °C
L1_1_UI1_DefaultValue	value	analog	normal	0 °C
L1_1_UI1_Offset	value	analog	normal	0 °C
L1_1_UI1_MinValue	value	analog	normal	0 °C
L1_1_UI1_MaxValue	value	analog	normal	50 °C

Figure 64: L-IOB Data Points in Web UI

# 10 Concepts

This chapter describes the basic concepts behind the configuration and data points of L-IOB devices. These concepts apply to the L-IOB part of the Configurator software (Chapter 11), the L-IOB host Web UI (Chapter 9), the L-IOB Web UI (Chapter 7), the L-IOB host LCD UI (Chapter 8), and the L-IOB LCD UI (Chapter 6). Observe that not all properties and data points will be available in all configuration instances. Some properties e.g. can only be seen or setup at configuration time, others only at run time.

---

## 10.1 Technology-Independent Data Points (BACnet Mode)

The LIOB-55x I/O modules in BACnet Mode support internal, technology independent data points as well as other advanced features such as alarming, scheduling, and trending (AST) similar to the LIOB I/O controllers. Since the main purpose of LIOB I/O modules is to directly expose I/Os to the control network (CEA-852 or BACnet/IP), these function will usually not be required. For more information on technology independent data points and AST, please refer to the L-INX user manual [1] or LIOB-x8x user manual [2].

---

## 10.2 Bus and Device Configuration

Each L-IOB device has certain configuration properties which are global to the whole bus (LIOB-Connect or LIOB-FT/IP device modes) or one device. The following sections describe these properties.

### 10.2.1 Index of first Device not in Daisy Chain (LIOB-Connect device mode)

This is a property which is only available for the LIOB-Connect port. It is only required if the LIOB-Connect bus is extended with a 3-wire cable (without select signal) instead of a 4-wire cable. In this case the property specifies the first device after the 3-wire cable

### 10.2.2 Station ID (L-INX Mode)

Each L-IOB device is assigned a station ID (1-24), unique to the L-IOB bus. The station ID represents the position of the L-IOB device in the L-IOB host configuration. In case of LIOB-Connect, it also represents the physical position in the daisy chain, see Chapter 5.

### 10.2.3 Minimum Firmware Version (L-INX Mode)

This property can be used to specify a minimum for the required firmware version of the connected L-IOB devices, e.g. to enable advanced functions in the Configurator which are only available from a certain L-IOB firmware version on.



### 10.2.4 Enabled (L-INX Mode)

The enabled flag can be used to disable certain L-IOB devices which are part of a common L-IOB host project but not part of a certain L-IOB host installation where this project shall be used. One could e.g. create a common L-IOB host project for 10 rooms where in some rooms, one or more L-IOB devices (resp. their data points) are not needed. In this case, the unneeded L-IOB devices can be disabled and the corresponding L-IOB units do not have to be physically installed.

### 10.2.5 Product Code

The product code is the model name of the L-IOB device, e.g. "LIOB-100"

### 10.2.6 Device Name

The device name is the user defined name of the L-IOB device.

### 10.2.7 PIN

The PIN code can be used to restrict manual access to the L-IOB LCD UI (See Chapter 6). Values can only be changed after the user enters the pin code using the jog dial of the L-IOB device.

### 10.2.8 Alternative Unit

This is a flag which is set if this device shows US units (instead of SI units).

### 10.2.9 Language

This is the language setting of the L-IOB LCD Display (English or German).

### 10.2.10 Group I/O Min/Max Send Times (LONMARK® Mode)

These are parameters to setup a minimum wait time and maximum time between updates of the digital group network variables in LONMARK® Mode.

### 10.2.11 NID

The NID (worldwide unique Node ID of each L-IOB device) is a standard requirement for each CEA-709 device. In L-INX Mode, it is used by the L-IOB host to detect L-IOB devices after a reboot and also to automatically enumerate L-IOB devices.

### 10.2.12 Translation Tables

Translation tables are used to translate a physical input value (resistance, voltage, current, or frequency) to the actual value, the sensor is supposed to measure (e.g. temperature). The configuration of translation tables is explained at the end of Section 11.2.3.

---

## 10.3 I/O Configuration

Each I/O in a L-IOB device has certain configuration properties which are specific to that I/O. Not all listed properties are available for all I/Os, dependent on the hardware type and certain other configuration properties. The following sections describe the I/O properties and their dependencies.

### 10.3.1 Name

The name property is available for all I/Os. It is the user defined name of the I/O (e.g.: 'Temperature1').

### 10.3.2 HardwareType

The hardware type property is available for all I/Os. The following hardware types are available (dependent on the L-IOB model):

- **IN Analog/Digital:** universal analog/digital input (UI) which can be configured to measure resistance, voltage, or current (with or without internal shunt). Observe that this hardware type is also used for the internal pressure sensor (e.g. 'PRESS' in LIOB-154). In this case, 0V refers to 0Pa (Pascal) and 10V to 500Pa.
- **IN Digital:** digital S0 input (DI).
- **OUT Analog:** analog 0-10 V output (AO).
- **OUT Relay 6A:** digital 6 A relay output (DO).
- **OUT Relay 16A:** digital 16 A relay output (DO).
- **OUT Triac:** digital 1 A triac output (DO).

This hardware type property can not be configured of course. Refer to Section 17.1 for a detailed specification of the different I/O hardware types.

### 10.3.3 SignalType

The signal type property is available for I/Os of hardware type "IN Analog/Digital". The following signal types can be configured:

- **Resistance:** measures resistance of about 1 k $\Omega$  to 100 k $\Omega$ . A value bigger than 500 k $\Omega$  is detected as a disconnected sensor (except if NoValCorr flag is set, see Section 10.3.16).
- **Voltage 0-10V:** measures voltage from 0 to 10 V.
- **Voltage 2-10V:** measures voltage from 2 to 10 V. A value smaller than 1.75 V is detected as a disconnected sensor (except if NoValCorr flag is set, see Section 10.3.16).
- **Current 4-20mA ext. Shunt:** measures current from 4 to 20 mA. A value smaller than 3.5 mA is detected as a disconnected sensor (except if NoValCorr flag is set, see Section 10.3.16). An external shunt of 249  $\Omega$  must be used for correct measurement.
- **Current 4-20mA int. Shunt:** measures current from 4 to 20 mA. A value smaller than 3.5 mA is detected as a disconnected sensor (except if NoValCorr flag is set, see Section 10.3.16). No external shunt is required. This setting is only available on some universal inputs which have an internal shunt, see Section 17.4. Observe that changing the signal type to this setting may result in changing the setting on other universal inputs too. In this case, a Configurator message will inform the user of the changes.

### 10.3.4 Interpretation

The interpretation property is available for all I/Os. Depending on the hardware type and signal type, the following interpretations can be configured:

- **CustomNTC:** This interpretation is only available for universal inputs (hardware type "IN Analog/Digital") with signal type "Resistance". It is used for connecting a custom NTC temperature sensor to the input. The parameters of the NTC can be setup as described in Section 10.3.27.

- **PT1000:** This interpretation is only available for universal inputs (hardware type “IN Analog/Digital”) with signal type “Resistance”. It is used for connecting a PT1000 temperature sensor to the input.
- **NTC10K:** This interpretation is only available for universal inputs (hardware type “IN Analog/Digital”) with signal type “Resistance”. It is used for connecting an NTC10K temperature sensor to the input.
- **NTC1K8:** This interpretation is only available for universal inputs (hardware type “IN Analog/Digital”) with signal type “Resistance”. It is used for connecting an NTC1K8 temperature sensor to the input.
- **Ni1000:** This interpretation is only available for universal inputs (hardware type “IN Analog/Digital”) with signal type “Resistance”. It is used for connecting an Ni1000 temperature sensor to the input.
- **Linear:** This interpretation is only available for universal inputs (hardware type “IN Analog/Digital”). It is used to perform a linear transformation from a physical input value (resistance, voltage, or current, see Section 10.3.3) to the actual value, the sensor is supposed to measure (e.g. temperature, see Section 10.3.5). The input range is specified by the signal type:
  - Resistance: 0 ... 10 k $\Omega$
  - Voltage 0-10V: 0 ... 10 V
  - Voltage 2-10V: 2 ... 10 V
  - Current 4-20mA ext. Shunt: 4 ... 20 mA
  - Current 4-20mA int. Shunt: 4 ... 20 mA

The output range is specified by MinValue and MaxValue, see Section 10.3.23. In case of signal type “Voltage 2-10V” e.g. a measured value of 2 V would be transformed into MinValue and a measured value of 10 V would be transformed into MaxValue.

- **Frequency:** This interpretation is available for all inputs. It is used to measure the frequency of the digital input resp. universal input in digital mode. The period used for measurement is specified by the MinSendTime parameter, see Section 10.3.25.
- **Translation Table:** This interpretation is only available for universal inputs (hardware type “IN Analog/Digital”). It is used to perform a transformation from a physical input value (resistance, voltage, or current, see Section 10.3.3) to the actual value, the sensor is supposed to measure (e.g. temperature, see Section 10.3.5) using a transformation table. The table can be selected with TransTable, see Section 10.3.26. The tables can be setup for each L-IOB device as explained at the end of Section 11.2.3.
- **Frequency Table:** This interpretation is available for all inputs. It is used to perform a transformation from a frequency value (measured as described above) to the actual value, the sensor is supposed to measure (e.g. velocity, see Section 10.3.5) using a transformation table. The table can be selected with TransTable, see Section 10.3.26. The tables can be setup for each L-IOB device as explained at the end of Section 11.2.3.
- **Physical Unit Count:** This interpretation is available for all inputs. It is used to count in a certain physical unit. The unit is setup with DataType and SIUnit\_OnText, see Sections 10.3.5 and 10.3.18. The increment for each pulse is setup using the Resolution property, see Section 10.3.19.

- **Digital:** This interpretation is available for all I/Os. In case of an analog output, the off and on output values are specified with OffValue and OnValue, see Section 10.3.30.
- **Pulse Count:** This interpretation is available for all inputs. It is used to count pulses of the digital input or universal input in digital mode. It is also used for connecting the code signal of STId card readers, see Section 10.5. Like in the “Physical Unit Count” interpretation, a unit and an increment can be setup for calculating a value of a certain physical unit. However, in case of the “Pulse Count” interpretation, this calculation is only used for display on the L-IOB LCD UI. The data point remains a 32-bit counter.
- **Occupancy:** This interpretation is available for all inputs. See Section 10.3.28 for details.
- **Switch Mode (LONMARK® Mode):** This interpretation is available for all inputs (restricted to LIOB-15x/45x in LONMARK® or Non-ECS device mode). See Section 10.4 for details.
- **Clock:** This interpretation is available for all interrupt-capable inputs. It is used for connecting the clock signal of STId card readers, see Section 10.5.
- **Card Data:** This interpretation is available for all inputs. It is used for connecting the data signal of STId card readers, see Section 10.5.
- **Analog:** This interpretation is only available for analog outputs (hardware type “OUT Analog”). It is used to output a voltage between 0 and 12 V. In case of using data type “Percentage” (see Section 10.3.5), the output value (in percent) coming from the L-IOB host is scaled using the MinValue and MaxValue properties (see Section 10.3.23). An output value of 50% would e.g. translate into an actual voltage of just in the middle between MinValue and MaxValue, an output value of 100% would translate into a voltage of MaxValue. Note that an output value of 0% is still always translated into 0V. As soon as the output value is slightly raised above 0% however, the voltage jumps to MinValue.
- **PWM:** This interpretation is available for all outputs. It is used to generate a pulse width modulated output signal. The period is setup with PWMPeriod, see Section 10.3.31. In case of an analog output, the off and on output values are specified with OffValue and OnValue, see Section 10.3.30. The output value (in percent) coming from the L-IOB host is scaled using the MinValue and MaxValue properties (see Section 10.3.23). An output value of 50% would e.g. translate into an actual pulse width of just in the middle between MinValue and MaxValue, an output value of 100% would translate into a pulse width of MaxValue. Note that an output value of 0% is still always translated into zero pulse width (always off). As soon as the output value is slightly raised above 0% however, the pulse width jumps to MinValue. This scaling is typically used to correctly control slow actuators like heating valves. If a valve e.g. requires a pre-heating time of 1 min, using a PWM period of 10 min, the MinValue can be set to 10% to compensate the pre-heating time. For further information on optimal control of your actuator in PWM mode, please refer to the corresponding data sheet. When the output value (coming from the L-IOB host) changes during a PWM period, the new value will be applied in the current period if possible. If the value decreases, the physical output will be switched off earlier, or immediately, if the newly defined point in time has already elapsed. If the value increases, the physical output will be switched off later, if it was still switched on when the value changes. Otherwise, the new value will be applied starting with the next period. When a PWM output is in manual operating mode (see Section 10.3.11), a new period is started immediately whenever the manual value is changed.
- **Fading:** This interpretation is available for all analog outputs. It is equal to the “Analog” interpretation except for the behavior on a value change. The output is not immediately set to the new value but instead a slow fading from the current value to the new value is

performed. The transition time used for fading from the current value to the new value (fading time) is setup in the property `DeadTime`, see Section 10.3.7. Since this time is constant, the transition speed depends on the difference between current and new value.

- **Ramping:** This interpretation is available for all analog outputs. It is equal to the “Fading” interpretation except that the `DeadTime` property (see Section 10.3.7) specifies the time it takes to ramp from the minimum value to the maximum value (ramping time). This way, the transition speed between current and new value is always equal, independent of the difference between the two values.

### 10.3.5 DataType

The data type property is available for all inputs with interpretation “Linear”, “Translation Table”, “Frequency Table”, “Physical Unit Count”, “Digital”, “Occupancy”, and “Switch Mode”, as well as for outputs with interpretation “Digital”, “Analog”, “Fading”, or “Ramping”. It specifies the physical quantity of the I/O. For outputs with interpretation “Digital”, the data type can be chosen between “Switch” and “Duration”. In case of “Duration”, the output has the following characteristics:

- If a positive output value is written, it is interpreted as a period (in [ms]) in which the output shall be switched on. After that period, the output is automatically switched off again. The feedback value of the output is initially set to the given period and stays there until the output is switched off. After that, the feedback value is set to 0.
- If 0 is written to the output value, the output is switched off immediately.
- If a negative output value is written, the output is switched on permanently.

### 10.3.6 SNVT

The SNVT (Standard Network Variable Type) is available for all I/Os on a LIOB-15x/45x model in LONMARK® or Non-ECS device mode. Depending on the interpretation, different SNVTs will be available for selection. The SNVT determines the type of all changeable network variables and configuration properties of the I/O.

### 10.3.7 DeadTime for Fading and Ramping

For interpretation “Fading”, the `DeadTime` property specifies the fading time from the current value to the new value. For interpretation “Ramping”, the `DeadTime` property specifies the ramping time from the minimum to the maximum value (independent of current and new value).

### 10.3.8 IOFunc, GroupNumber, and DeadTime for Interlocked Mode

The IO function, group number, and dead time properties are available for all digital outputs. If `IOFunc` is set to “Interlocked”, the `GroupNumber` property can be used to form different interlocked groups. Further, for each interlocked output, the data type can be chosen between “Switch” and “Duration”. The digital outputs belonging to one interlocked group have the following characteristics:

- Data Type “Switch”:
  - If “true” is written to the output value, the output is switched on permanently.
  - If “false” is written to the output value, the output is switched off immediately.
- Data Type “Duration”:

- If a positive output value is written, it is interpreted as a period (in [ms]) in which the output shall be switched on. After that period, the output is automatically switched off again. The feedback value of the output is initially set to the given period and stays there until the output is switched off. After that, the feedback value is set to 0.
- If 0 is written to the output value, the output is switched off immediately.
- If a negative output value is written, the output is switched on permanently.
- Whenever an output is switched on (as described above), it is checked before if another output in the same interlocked group is already switched on. In this case, the other output is switched off immediately. Then, for a period setup with **DeadTime**, all outputs of the group remain off. After that, finally the new output is switched on (either for a certain period of permanently).

The interlocked mechanism can be used e.g. for sunblind motors where it must be ensured that the up and down motors are never active at the same time.

### 10.3.9 IOFunc, GroupNumber, and SubGroupNumber for Switch Mode

The IO function, group number, and sub group number properties are available for all inputs with interpretation “Switch Mode” (only available for LONMARK® / Non-ECS device mode). If **IOFunc** is set to “2-Switch-Group”, the **GroupNumber** property can be used to form different two-input groups. With the **SubGroupNumber** property, the two inputs must be assigned to either the function “Switch 1” or “Switch 2”. Refer to Section 10.4 for more information on the switch mode.

### 10.3.10 IOFunc, GroupNumber, and SubGroupNumber for Card Reader Mode

The IO function, group number, and sub group number properties are available for all inputs used for connecting the signals of an STId card reader, see Section 10.5.

### 10.3.11 OperatingMode, OverrideValue, and DefaultValue

The operating mode property is available for all I/Os. For inputs, the **OperatingMode** property has the following meaning:

- **Disabled**: The physical input is disabled and the data point is set to **DefaultValue**. This can be used to disable unused inputs.
- **Auto**: The input measures the value from the connected sensor.
- **Override**: The physical input is disabled and the data point is set to **OverrideValue**.
- **Manual**: The physical input is disabled and the data point is set by the user on the L-IOB LCD UI (see Chapter 6) or L-IOB host Web UI (see Chapter 9). This can be used to simulate input values for the connected node(s) or the L-IOB host. Observe that this function is available in the L-IOB host Web UI works even if the corresponding L-IOB device is not physically present yet.

The **DefaultValue** is also used for inputs, when no sensor value has yet been read from the physical input or a sensor error is detected. For outputs, the **OperatingMode** property has the following meaning:

- **Disabled**: The output value is ignored in the L-IOB device and the physical output (as well as the feedback value) is set to **DefaultValue**.

- **Auto:** The physical output (and feedback value) is set as requested by the output value set from the network or L-IOB host (L-INX mode).
- **Override:** The output value is ignored in the L-IOB device and the physical output (as well as the feedback value) is set to **OverrideValue**. This can be used e.g. for providing a constant supply voltage to a sensor.
- **Manual:** The output value is ignored in the L-IOB device and the physical output (as well as the feedback value) is set by the user on the LIOB LCD UI (see Chapter 6). This can be used to test actuators.

The **DefaultValue** is also used for outputs when no output value has yet been received by the L-IOB device resp. after a reboot, if the persistent flag is not set (see Section 10.3.12).

### 10.3.12 Persistent Flag

The persistent flag is available for all outputs. It specifies the behavior of the L-IOB outputs after a power cycle of the L-IOB device or when the L-IOB device loses connection to the L-IOB host. If it is set, the output is set to the last stored value in the mentioned scenarios. If it is cleared, the output is set to the DefaultValue (see Section 10.3.11). Since the output values are only stored in the L-IOB device approx. every 20 minutes, it is possible that even in the first case, the output value temporarily changes.

### 10.3.13 Invert Flag

The invert flag is available for all I/Os in digital/PWM mode or where the input is used to count pulses or detect occupancy. In the first case, the invert flag is used to invert the input or output. In the second case, the flag specifies whether the pulse shall be detected at the positive or negative edge. For occupancy detection, the flag specifies the occupied state of the sensor. Observe that if the SignalType is set to "Resistance" (see Section 10.3.3), the Invert flag is set by default. This is because the ON / OCCUPIED state usually refers to a low resistance value ("CLOSED" contact) whereas the OFF / UNOCCUPIED state usually refers to a high resistance value ("OPEN" contact).

### 10.3.14 AnalInvert Flag

The analog invert flag is available for all voltage or current inputs with interpretation "Linear" or "Translation Table" (see Section 10.3.4) and for all outputs with interpretation "Analog", "Fading", or "Ramping". It inverts the analog range between the MinValue and the MaxValue. For a 0-10V sensor with linear interpretation e.g., 0V would result in a live value of MaxValue and 10V results in the MinValue.

### 10.3.15 Sqrt Flag

The square root flag is available for all voltage, current, or pressure inputs with interpretation "Linear" or "Translation Table" (see Section 10.3.4). It performs a square root operation on the signal range. The formulas for the different sensor signal types are listed below:

- 0-10V Sensor or Pressure Sensor:  $Usqrt = \sqrt{U * 10V}$
- 2-10V Sensor:  $Usqrt = 2V + \sqrt{(U - 2V) * 8V}$
- 4-20mA Sensor:  $Isqrt = 4mA + \sqrt{(I - 4mA) * 16mA}$

Values below the signal range (below 0V, 2V, or 4mA) are not converted. The *Usqrt* or *Isqrt* value is then used instead of the *U* or *I* value for further calculation (linear

transformation or translation table). The square root flag can be used e.g. to easily calculate a flow value instead of a differential pressure.

### 10.3.16 NoValCorr Flag

The NoValCorr flag is available for all inputs with signal type “Resistance”, “Voltage 2-10V”, “Current 4-20mA ext. Shunt”, or “Current 4-20mA int. Shunt” and interpretation “CustomNTC”, “PT1000”, “NTC10K”, “NTC1K8”, “Ni1000”, “Linear”, or “Translation Table”. If it is set, the detection of disconnected sensors is switched off and every measured value is processed, see also Section 10.3.3.

### 10.3.17 PulseTime Flag

The pulse time flag is available for all inputs with interpretation “Pulse Count” or “Physical Unit Count” (see Section 10.3.4). It activates the pulse time data point. Note that by setting this flag, additional traffic is generated.

### 10.3.18 SIUnit\_OnText and USUnit\_OffText

The SI unit / on text and US unit / off text properties are available for all I/Os. In case of analog values, the **SIUnit\_OnText** property specifies the unit in SI mode, in case of digital values, it specifies the ON text (shown when the digital I/O is active). In case of analog values, the **USUnit\_OffText** property specifies the unit in US mode, in case of digital values, it specifies the OFF text (shown when the digital I/O is inactive). Using the Configurator (**Project Settings**), the user can choose between SI and US units.

### 10.3.19 Resolution

The resolution property is available for all I/Os with an analog data type. It specifies the resolution of the value display in the L-IOB LCD UI as well as the step width for the L-IOB jog dial when manually setting an analog value or property of that I/O. For the interpretations “Physical Unit Count” and “Pulse Count”, it also specifies the increment for each pulse, see Section 10.3.4.

### 10.3.20 MultUS and OffsUS

The US Multiplier and Offset properties are available for all I/Os with an analog data type and are calculated automatically. Using the Configurator, the user can choose between SI and US units. In case of US units, the I/O values displayed in the L-IOB host Web UI and L-IOB LCD UI are converted using these properties ( $\text{ValueUS} = \text{ValueSI} * \text{MultUS} + \text{OffsUS}$ ). The US unit is setup in the USUnit\_OffText property, see Section 10.3.18. Observe that the properties setup in the Configurator as well as the connected data points will still always carry SI units.

### 10.3.21 DisplayOnSymbol and DisplayOffSymbol

The display on/off symbol properties are available for inputs with Interpretation “Digital” (see Section 10.3.4). They are used to specify the display of the two digital states ON and OFF. For both these states, the following symbols can be chosen:

- **OPEN**: open switch symbol
- **CLOSED**: closed switch symbol
- **OK**: check symbol
- **ERROR**: exclamation mark symbol



### 10.3.22 Offset

The offset property is available for inputs with an analog data type. It is added at the end of the calculation to the (already processed) value. This way, e.g. temperature sensors can be calibrated in each room without changing the common application. Observe that in the LCD UI, the resulting input value will be displayed next to the offset value to simplify calibration.

### 10.3.23 MinValue and MaxValue

The minimum and maximum value properties are available for all I/Os with an analog data type (except for Interpretation “Physical Unit Count”) as well as for inputs with interpretation “Digital”, “Occupancy, or “Switch Mode”. They are used for:

- scaling inputs with interpretation “Linear” (see Section 10.3.4),
- scaling outputs with interpretation “Analog”, “PWM”, “Fading”, or “Ramping (see Section 10.3.4),
- scaling the bar icon in the L-IOB LCD UI (see Section 6.2),
- setting the active and inactive values of the SNVT\_occupancy for digital or occupancy inputs (LONMARK® / Non-ECS device mode only),
- limiting the dimming values in Switch Mode (LONMARK® / Non-ECS device mode only, see Section 10.4).

### 10.3.24 COV and MaxSendTime

The **Change-Of-Value** property is available for all inputs with an analog data type. It is used to specify a minimum delta value required to trigger a data point update. If the input value only changes within a range of  $-\text{COV}$  to  $+\text{COV}$ , no update is generated. In any case, after **MaxSendTime** an update is generated to be sure to get the latest value at least at some point in time. If COV is set to 0, every input value change generates an update of the attached data point.

Observe that the **MaxSendTime** property is available for all I/Os (analog and digital) to act as a heartbeat function. For outputs, it is applied both on the output value (heartbeat *to* L-IOB device) and feedback value (heartbeat *from* L-IOB device). Whenever an update is sent from a L-IOB device to the host because of a max send time, the connected data point in the host (input or feedback value) is updated too, even if there is no value change. In cases where this behavior is not desired, the “Analog Point COV Increment” or “Only notify on COV” property of the corresponding host data point must be set. See Section 11.2.4 for where these data point settings can be made.

### 10.3.25 MinSendTime

The minimum send time property is available for all I/Os. It specifies the minimum time that has to pass before a new update of an input or output feedback value is generated. If MinSendTime is set to 0, all changes of the inputs or output feedbacks immediately generate updates. For inputs with interpretation “Frequency” or “Frequency Table” (see Section 10.3.4), the MinSendTime property also specifies the period used for frequency measurement. For inputs with interpretation “Switch Mode”, the MinSendTime property specifies the repeat time for the long push events, see Section 10.4.

### 10.3.26 TransTable

The translation table property is available for all inputs with interpretation “Translation Table” or “Frequency Table” (see Section 10.3.4). It specifies the translation table which

shall be used for the translation. The configuration of translation tables is explained at the end of Section 11.2.3.

### 10.3.27 NTC\_Rn, NTC\_Tn, and NTC\_B

The Rn, Tn, and B properties are available for inputs with interpretation “Custom NTC” (see Section 10.3.4). Tn is specified in degree Celsius. Rn is the resistance of the NTC temperature sensor at the temperature Tn. The temperature value is calculated using the formula:

$$T = B * (Tn + 273.16 \text{ degC}) / (B + \ln(R / Rn) * (Tn + 273.16 \text{ degC})) - 273.16 \text{ degC}.$$

T is the calculated temperature in degree Celsius and R is the measured resistance of the NTC temperature sensor.

### 10.3.28 HoldTime and DebounceTime

These properties are available for all inputs where the Interpretation is set to “Occupancy” or “Switch Mode”. The HoldTime is also available for the data signal of STId card readers, see Section 10.5. The DebounceTime is also available for inputs with interpretation “Digital”.

In interpretation “Occupancy”, the occupied state is detected using a sensor which becomes active (e.g. closes a contact) or creates pulses whenever the room is occupied. These states are converted to an occupancy value in the following way:

- When the occupied state (or a pulse) is detected, the value changes to OCCUPIED and stays there for at least the **HoldTime**.
- As long as the sensor stays in the occupied state or whenever new pulses are detected during the **HoldTime**, the timer for the **HoldTime** is started again.
- When the sensor stays in the unoccupied state until the **HoldTime** exceeds, the state goes back to UNOCCUPIED.
- From this moment on, all pulses from the sensor are ignored for as long as the **DebounceTime** lasts. This is useful e.g. when light is switched off due to detecting the UNOCCUPIED state which leads to new pulses of the sensor and in turn leads to switching on the light again. To break this loop, the debounce time is used.

In case of interpretation “Switch Mode”, the **HoldTime** specifies the time to distinguish between short and long pushes. The **DebounceTime** is used to distinguish between a combined push or two consecutive pushes of a 2-switch group.

In case of interpretation “Digital”, the **DebounceTime** is used for spike suppression. It specifies the maximum duration of an unwanted spike to be suppressed.

### 10.3.29 EventGroup Modes and Values

The EventGroupXyzModes (e.g. **EventGroup1ShortPushMode**) and EventGroupXyzValues (e.g. **EventGroup1ShortPushValue**) are available for Inputs with Interpretation “Switch Mode” (LONMARK® / Non-ECS device mode only). Refer to Section 10.4 for more information.

### 10.3.30 OffValue and OnValue

The off and on value properties are available for analog outputs in digital mode. They specify the physical values (voltages) to be output for the OFF (inactive) and ON (active) state.

### 10.3.31 PWMPeriod

The PWM period property specifies the period (in seconds) for outputs with Interpretation “PWM” (Pulse Width Modulation), see Section 10.3.4.

### 10.3.32 NominalPower

The nominal power property is available for all outputs. It specifies the nominal resp. average expected power consumption of the device or appliance (e.g. lamp) connected to the output. For digital outputs it specifies the average power when the output is activated (e.g. relay closed), for analog outputs it specifies the average power when the output is set to 10 V. The nominal power property is used to calculate the energy count data point of the output.

---

## 10.4 Switch Mode (LONMARK® Mode)

This chapter only applies to LIOB-15x/45x models in LONMARK® or Non-ECS device mode.

The switch mode is available for all inputs as an interpretation option, see Section 10.3.4. It implements a configurable switch function with an optional secondary input and an additional feedback input network variable ‘nviInSwitchFb’ of type SNVT\_switch (available for each input). An input in switch mode basically acts as a digital input with some additional functions described in the following sections.

### 10.4.1 General Function

Whenever the state of an input in switch mode changes (a connected button or switch is pressed, released, or switched), the live value network variable updates its value according to the configuration properties described below. The type of the live value NV is determined by the **Data Type** property (see Section 10.3.5) and can be set to Switch (SNVT\_switch), Scene (SNVT\_scene), or Setting (SNVT\_setting). The following configuration properties are available for each input in switch mode:

- EventGroup1ShortPushMode / EventGroup1ShortPushValue,
- EventGroup1ShortReleaseMode / EventGroup1ShortReleaseValue,
- EventGroup1LongPushMode / EventGroup1LongPushValue,
- EventGroup1LongReleaseMode / EventGroup1LongReleaseValue,
- EventGroup2ShortPushMode / EventGroup2ShortPushValue,
- EventGroup2ShortReleaseMode / EventGroup2ShortReleaseValue,
- EventGroup2LongPushMode / EventGroup2LongPushValue,
- EventGroup2LongReleaseMode / EventGroup2LongReleaseValue,

Whether EventGroup1 or EventGroup2 is active is either determined by toggling between them with one input (whenever the input becomes inactive) or explicitly, by using two inputs (see Section 10.4.2). The flow chart of the switch mode is depicted in Figure 65.

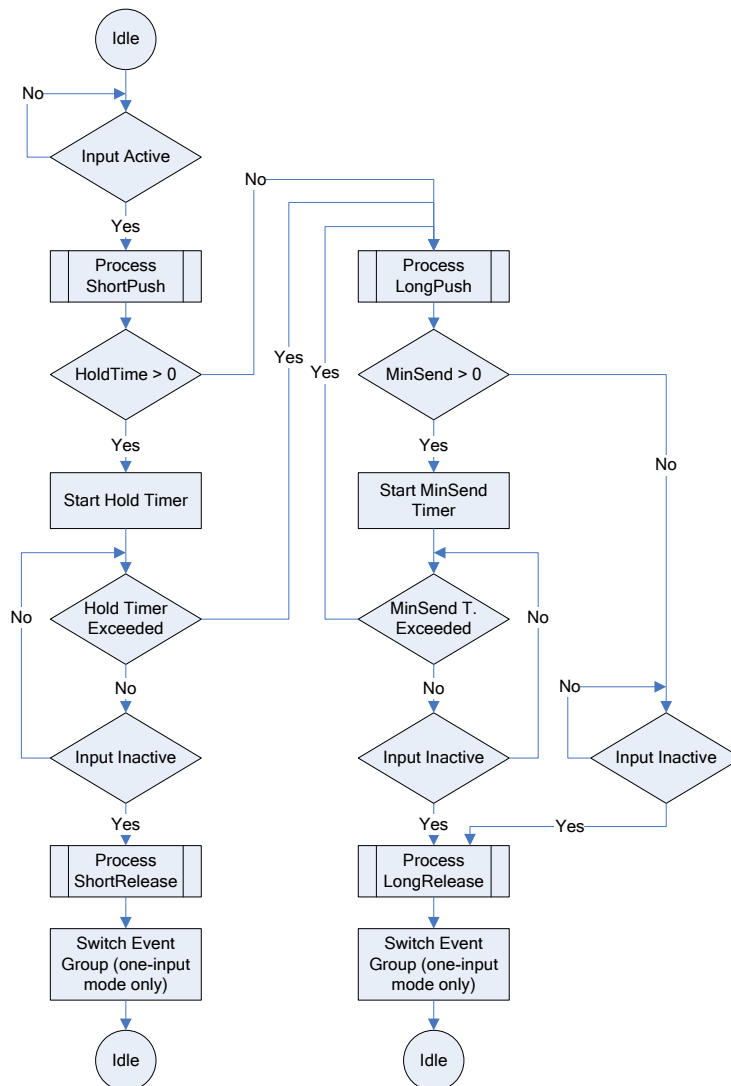

Figure 65: Switch Mode Flow Chart

The event ShortPush is fired when the input becomes active. ShortRelease is fired when the input becomes inactive again before the **HoldTime** (see Section 10.3.28). LongPush is fired when the input is still active after **HoldTime**. If the **MinSendTime** (see Section 10.3.25) is greater than 0 for the input, the LongPush event is fired consecutively with a period of **MinSendTime** as long as the input stays active. If the input becomes inactive again after **HoldTime**, LongRelease is fired. For each event, a Mode and a Value property is available as listed above. The Value properties determine the values which shall be sent out when the corresponding events occur. They therefore always have the same type as the live value network variable of the input. The Mode properties determine the modes and conditions under which the Values are sent out. They are enumerations which define the following modes:

- **Disabled:** No value is sent out if the event occurs. If all modes of EventGroup2 are set to disabled, the EventGroup2 is disabled completely (no switching between event groups).
- **Set:** The value is sent out as specified.
- **Set if Feedback State is 0:** Same as 'Set' but only if the feedback .state member is 0. If not, the event group is switched and the corresponding Mode/Value properties of the other event group are processed instead.

- **Set if Feedback State is 1:** Same as ‘Set’ but only if the feedback .state member is 1. If not, the event group is switched and the corresponding Mode/Value properties of the other event group are processed instead.
- **Increment** (SNVT\_switch only): The last value of the feedback .value member (when the feedback .state member was > 0) is increased by the .value member of the corresponding configuration property (EventGroupXYZValue) and sent with the .state member specified in the corresponding configuration property. The sent .value member is not increased above the .value member of the MaxValue property (see Section 10.3.23).
- **Increment if Feedback State is 0** (SNVT\_switch only): Same as ‘Increment’ but only if the feedback .state member is 0. If not, the event group is switched and the corresponding Mode/Value properties of the other event group are processed instead.
- **Increment if Feedback State is 1** (SNVT\_switch only): Same as ‘Increment’ but only if the feedback .state member is 1. If not, the event group is switched and the corresponding Mode/Value properties of the other event group are processed instead.
- **Decrement** (SNVT\_switch only): The last value of the feedback .value member (when the feedback .state member was > 0) is decreased by the .value member of the corresponding configuration property (EventGroupXYZValue) and sent with the .state member specified in the corresponding configuration property. The sent .value member is not decreased below the .value member of the MinValue property (see Section 10.3.23).
- **Decrement if Feedback State is 0** (SNVT\_switch only): Same as ‘Decrement’ but only if the feedback .state member is 0. If not, the event group is switched and the corresponding Mode/Value properties of the other event group are processed instead.
- **Decrement if Feedback State is 1** (SNVT\_switch only): Same as ‘Decrement’ but only if the feedback .state member is 1. If not, the event group is switched and the corresponding Mode/Value properties of the other event group are processed instead.
- **Set State** (SNVT\_switch only): The last value of the feedback .value member (when the feedback .state member was > 0) is sent with the .state member specified in the corresponding configuration property (EventGroupXYZValue). It is made sure that the sent .value member stays between the .value members of the MinValue and MaxValue properties (see Section 10.3.23).
- **Set State if Feedback State is 0** (SNVT\_switch only): Same as ‘Set State’ but only if the feedback .state member is 0. If not, the event group is switched and the corresponding Mode/Value properties of the other event group are processed instead.
- **Set State if Feedback State is 1** (SNVT\_switch only): Same as ‘Set State’ but only if the feedback .state member is 1. If not, the event group is switched and the corresponding Mode/Value properties of the other event group are processed instead.
- **Set Value and Set Feedback State to 0** (SNVT\_scene / SNVT\_setting only): The value is sent out as specified and the feedback .state member is internally set to 0.
- **Set Value and Set Feedback State to 1** (SNVT\_scene / SNVT\_setting only): The value is sent out as specified and the feedback .state member is internally set to 1.
- **Set Value and Set Feedback State to 0 if Feedback State is 1** (SNVT\_scene / SNVT\_setting only): Same as ‘Set Value and Set Feedback State to 0’ but only if the feedback .state member is 1. If not, the event group is switched and the corresponding Mode/Value properties of the other event group are processed instead.

- **Set Value and Set Feedback State to 1 if Feedback State is 0** (SNVT\_scene / SNVT\_setting only): Same as ‘Set Value and Set Feedback State to 1’ but only if the feedback .state member is 0. If not, the event group is switched and the corresponding Mode/Value properties of the other event group are processed instead.

When using the conditional modes (... if Feedback State is 0/1), it must be made sure that the feedback network variable of the input always represents the current state of the object which shall be controlled. There are three possible ways to achieve that:

- The object which is controlled (e.g. a light) delivers a SNVT\_switch network variable, which can be bound to the feedback network variable (‘nviInSwitchFb’) of the input.
- A turn-around binding between the live value (‘nvoInValue’) and the feedback network variable (‘nviInSwitchFb’) of the input is created. This is only possible if the **DataType** of the input is set to Switch (SNVT\_switch).
- The feedback .state member is internally controlled using the ‘Set Value and Set Feedback State to ...’ modes. This is only possible if the **DataType** of the input is set to Scene (SNVT\_scene) or Setting (SNVT\_setting).

## 10.4.2 Two-Input Mode

Two inputs can be grouped together using the **IOFunc**, **GroupNumber**, and **SubGroupNumber** properties (see Section 10.3.9). Each event group is permanently assigned to a specific input and there is no back and forth between the two event groups. EventGroup1 is assigned to the input with the **SubGroupNumber** ‘Switch 1’ and EventGroup2 is assigned to the input with the **SubGroupNumber** ‘Switch 2’. The **GroupNumber** property must be the same for both inputs.

In this case, both event groups described in Section 10.4.1 are defined in the first input object (‘Switch 1’). The two free event groups (in combination with the **HoldTime** and **MinSendTime**) of the second input are used to define the behavior when both inputs become active ‘at the same time’, meaning within the **DebounceTime** (see Section 10.3.28). The release events are fired when at least one input becomes inactive again. Both inputs must become inactive again before any new event is fired after that. The live value and feedback network variables of both inputs are fully functional. Between the two feedback network variables, the latest received value always wins.

## 10.4.3 Examples

The following sections present some typical examples of using the switch mode. All examples can be found as I/O object template files in the folder ‘LIOB\objects’ of the L-INX Configurator Software. Since the switch mode is available both for universal and digital inputs, there are two versions of each example file: ‘UI\_xyz.xml’ and ‘DI\_xyz.xml’. The example files using the two-input mode are named ‘xyz\_1.xml’ and ‘xyz\_2.xml’. If several two-input (‘two\_button’) examples are used within one L-IOB device, the **GroupNumber** properties must be changed so that each 2-Switch-Group has a unique group number.

### 10.4.3.1 Simple Switch

This example is implemented in the following I/O object template files:

- UI\_simple\_switch.xml (universal input)
- DI\_simple\_switch.xml (digital input)

The following properties are changed (from the default values) in this example:

- **Data Type** = Switch (SNVT\_switch, members: value / state)
- **EventGroup1ShortPushMode** = Set
- **EventGroup1ShortPushValue** = 100 / 1
- **EventGroup1LongReleaseMode** = Set
- **EventGroup1LongReleaseValue** = 0 / 0

When the input is activated (switched on), 100/1 is sent out. When the input is deactivated, (switched off), 0/0 is sent out. Observe that the **HoldTime** is set to 0 to prevent the ShortRelease event from occurring.

### 10.4.3.2 One-Button Toggle

This example is implemented in the following I/O object template files:

- UI\_one\_button\_toggle.xml (universal input)
- DI\_one\_button\_toggle.xml (digital input)

The following properties are changed (from the default values) in this example:

- **Data Type** = Switch (SNVT\_switch, members: value / state)
- **EventGroup1ShortPushMode** = Set if Feedback State is 0
- **EventGroup1ShortPushValue** = 100 / 1
- **EventGroup2ShortPushMode** = Set if Feedback State is 1
- **EventGroup2ShortPushValue** = 0 / 0

When the input is activated (button is pressed) and the feedback .state member is 0, 100/1 is sent out. If the feedback .state member is 1, 0/0 is sent out. It does not matter in which event group the input is currently in, since the conditional modes always make sure that the live value toggles. Observe that for this example, a turnaround network variable binding from the live value ('nvoInValue') to the feedback ('nviInSwitchFb') of the input object must be created.

### 10.4.3.3 One-Button Dimming

This example is implemented in the following I/O object template files:

- UI\_one\_button\_dimming.xml (universal input)
- DI\_one\_button\_dimming.xml (digital input)

The following properties are changed (from the default values) in this example:

- **Data Type** = Switch (SNVT\_switch, members: value / state)
- **MinValue** = 10 / 1
- **MaxValue** = 100 / 1
- **MinSendTime** = 0.2s
- **HoldTime** = 1s
- **EventGroup1ShortReleaseMode** = Set State if Feedback State is 0
- **EventGroup1ShortReleaseValue** = 0 / 1
- **EventGroup1LongPushMode** = Increment
- **EventGroup1LongPushValue** = 1 / 1
- **EventGroup2ShortReleaseMode** = Set if Feedback State is 1

- **EventGroup2ShortReleaseValue** = 0 / 0
- **EventGroup2LongPushMode** = Decrement
- **EventGroup2LongPushValue** = 1 / 1

When the input is activated shortly (button is pressed shortly) and the feedback .state member is 0, the last feedback .value member (when the .state member was > 0) is sent out along with the .state member 1 (light is switched on). Using the ‘Set State ...’ mode ensures that the last dimming value is restored. When the input is activated shortly (button is pressed shortly) and the feedback .state member is 1, 0/0 is sent out (light is switched off). If the input is activated for longer than 1s (HoldTime), the light is switched on and the .value member is incremented or decremented by 1 each 0.2s (MinSendTime). Using the MinValue property, it is made sure that the light level never goes below 10% as long as it is switched on. Observe that for this example, a turnaround network variable binding from the live value (‘nvoInValue’) to the feedback (‘nviInSwitchFb’) of the input object must be created.

#### 10.4.3.4 Rocker Switch

This example is implemented in the following I/O object template files:

- UI\_rocker\_switch\_1.xml / UI\_rocker\_switch\_2.xml (universal inputs)
- DI\_rocker\_switch\_1.xml / DI\_rocker\_switch\_2.xml (digital inputs)

This example uses two inputs in a 2-Switch-Group. For the first input, the following properties are changed (from the default values) in this example:

- **DataType** = Switch (SNVT\_switch, members: value / state)
- **IOFunc** = 2-Switch-Group
- **GroupNumber** = X (must be the same as for second input)
- **SubGroupNumber** = Switch 1
- **EventGroup1ShortPushMode** = Set
- **EventGroup1ShortPushValue** = 100 / 1
- **EventGroup2ShortPushMode** = Set
- **EventGroup2ShortPushValue** = 0 / 0

For the second input, the following properties are changed (from the default values) in this example:

- **DataType** = Switch (SNVT\_switch, members: value / state)
- **IOFunc** = 2-Switch-Group
- **GroupNumber** = X (must be the same as for first input)
- **SubGroupNumber** = Switch 2

When the first input is activated (rocker switch up), 100/1 is sent out. When the second input is activated (rocker switch down), 0/0 is sent out.

#### 10.4.3.5 Two-Button Dimming

This example is implemented in the following I/O object template files:

- UI\_two\_button\_dimming\_1.xml / UI\_two\_button\_dimming\_2.xml (universal inputs)
- DI\_two\_button\_dimming\_1.xml / DI\_two\_button\_dimming\_2.xml (digital inputs)

This example uses two inputs in a 2-Switch-Group. For the first input, the following properties are changed (from the default values) in this example:



- **DataType** = Switch (SNVT\_switch, members: value / state)
- **IOFunc** = 2-Switch-Group
- **GroupNumber** = X (must be the same as for second input)
- **SubGroupNumber** = Switch 1
- **MinValue** = 10 / 1
- **MaxValue** = 100 / 1
- **MinSendTime** = 0.2s
- **HoldTime** = 1s
- **DebounceTime** = 0.1s
- **EventGroup1ShortReleaseMode** = Set State
- **EventGroup1ShortReleaseValue** = 0 / 1
- **EventGroup1LongPushMode** = Increment
- **EventGroup1LongPushValue** = 1 / 1
- **EventGroup2ShortReleaseMode** = Set
- **EventGroup2ShortReleaseValue** = 0 / 0
- **EventGroup2LongPushMode** = Decrement
- **EventGroup2LongPushValue** = 1 / 1

For the second input, the following properties are changed (from the default values) in this example:

- **DataType** = Switch (SNVT\_switch, members: value / state)
- **IOFunc** = 2-Switch-Group
- **GroupNumber** = X (must be the same as for first input)
- **SubGroupNumber** = Switch 2
- **HoldTime** = 3s
- **DebounceTime** = 0.1s
- **EventGroup1ShortReleaseMode** = Set
- **EventGroup1ShortReleaseValue** = 100 / 1
- **EventGroup1LongPushMode** = Set
- **EventGroup1LongPushValue** = 0 / -1

The first input is configured and works exactly like the input in the one-button dimming example (Section 10.4.3.3) except for the conditional modes. A condition is not needed here since the event groups are explicitly mapped to the two inputs. Additionally, the properties of the second input are configured to setup the operation for pressing both buttons at the same time (resp. within the DebounceTime of 0.1s). If both buttons are pressed shortly, the light is fully switched on to 100%. If both buttons are pressed for longer than 3s (HoldTime of second input), the .state member is set to -1 which could be used to release control of the light. Observe that for this example, a turnaround network variable binding from the live value ('nvoInValue') to the feedback ('nviInSwitchFb') of the input object must still be created to be sure the dimming value is restored correctly.

#### 10.4.3.6 Two-Button Sunblinds

This example is implemented in the following I/O object template files:

- UI\_two\_button\_sunblinds\_1.xml / UI\_two\_button\_sunblinds\_2.xml (universal inputs)
- DI\_two\_button\_sunblinds\_1.xml / DI\_two\_button\_sunblinds\_2.xml (digital inputs)

This example uses two inputs in a 2-Switch-Group. For the first input, the following properties are changed (from the default values) in this example:

- **DataType** = Setting (SNVT\_setting, members: function / setting / rotation)
- **IOFunc** = 2-Switch-Group
- **GroupNumber** = X (must be the same as for second input)
- **SubGroupNumber** = Switch 1
- **HoldTime** = 3s
- **DebounceTime** = 0.1s
- **EventGroup1ShortPushMode** = Set
- **EventGroup1ShortPushValue** = SET\_UP / 0 / 0
- **EventGroup1ShortReleaseMode** = Set
- **EventGroup1ShortReleaseValue** = SET\_STOP / 0 / 0
- **EventGroup1LongPushMode** = Set
- **EventGroup1LongPushValue** = SET\_STATE / 100 / 0
- **EventGroup2ShortPushMode** = Set
- **EventGroup2ShortPushValue** = SET\_DOWN / 0 / 0
- **EventGroup2ShortReleaseMode** = Set
- **EventGroup2ShortReleaseValue** = SET\_STOP / 0 / 0
- **EventGroup2LongPushMode** = Set
- **EventGroup2LongPushValue** = SET\_STATE / 0 / 0

For the second input, the following properties are changed (from the default values) in this example:

- **DataType** = Setting (SNVT\_setting, members: function / setting / rotation)
- **IOFunc** = 2-Switch-Group
- **GroupNumber** = X (must be the same as for first input)
- **SubGroupNumber** = Switch 2
- **DebounceTime** = 0.1s
- **EventGroup1ShortPushMode** = Set
- **EventGroup1ShortPushValue** = SET\_NUL / 0 / 0

When the first input is activated shortly (button pressed for less than HoldTime = 3s), the sunblinds go up for as long as the button is pressed (SET\_UP). When it is released, the sunblinds stop (SET\_STOP). When the second input is activated shortly (button pressed for less than HoldTime = 3s), the sunblinds go down for as long as the button is pressed (SET\_DOWN). When it is released, the sunblinds stop (SET\_STOP). When the first button is pressed for longer than 3s, the sunblinds go all the way up (SET\_STATE) except if it is pressed shortly again. When the second button is pressed for longer than 3s, the sunblinds go all the way down (SET\_STATE) except if it is pressed shortly again. If both buttons are pressed at the same time (resp. within the DebounceTime of 0.1s), control of the sunblinds is released (SET\_NUL).

---

## 10.5 STId Card Reader Mode

The L-IOB devices support STId card readers running the ISO2 protocol. Refer to Section 17.4 and the following sections for information on which L-IOB models support STId card readers. The card readers have three signals which must be connected to inputs on the L-IOB device, as explained in the following sections.

### 10.5.1 Code Signal

The code signal of the card reader must be connected to a universal or digital input of the L-IOB device. The following properties must be set for that input:

- SignalType (if universal input): “Voltage 0-10V”.
- Interpretation: “Pulse Count”.
- IOFunc: “Cardreader ISO2”.
- GroupNumber: must be equal for all three signals of one card reader.
- SubGroupNumber: will automatically be set to “Code”.
- Invert: checked if signal is low active, check data sheet of card reader.

In its live value, this L-IOB input will represent the number of codes read from the card reader.

### 10.5.2 Data Signal

The data signal of the card reader must be connected to a universal or digital input of the L-IOB device. The following properties must be set for that input:

- SignalType (if universal input): “Voltage 0-10V”.
- Interpretation: “Card Data”.
- IOFunc: will automatically be set to “Cardreader ISO2”.
- GroupNumber: must be equal for all three signals of one card reader.
- SubGroupNumber: will automatically be set to “Data”.
- Invert: depends on implementation of card reader, check data sheet.
- HoldTime: specifies the time, a new code remains in the L-IOB data point. After this time, the data point is set back to “0xBF ...”, which means “not available”. If the HoldTime is set to 0, the last read value remains until a new value is read.

In its live value, this L-IOB input will represent the read code in a 20-byte array (40 decimal digits). In LONMARK® mode, the SNVT\_magcard (86) is used.

### 10.5.3 Clock Signal

The clock signal of the card reader must be connected to a interrupt-capable universal or digital input of the L-IOB device. The corresponding interpretation “Clock” will only be available in the Configurator software, if the input is interrupt-capable. The following properties must be set for that input:

- SignalType (if universal input): “Voltage 0-10V”.

- Interpretation: “Clock”.
- IOFunc: will automatically be set to “Cardreader ISO2”.
- GroupNumber: must be equal for all three signals of one card reader.
- SubGroupNumber: will automatically be set to “Clock”.
- Invert: checked if signal is low active, check data sheet of card reader.

The live value of that L-IOB input will not deliver any useful data.

---

## 10.6 Data Points (L-INX Mode)

This section describes the data points available in a L-IOB host which has L-IOB devices connected to the LIOB-Connect bus (LIOB-10x models), LIOB-FT bus (LIOB-15x models in LIOB-FT device mode), or LIOB-IP bus (LIOB-45x/55x models in LIOB-IP device mode). For each I/O, the most basic data points are created automatically (input value, output value, feedback). In the Configurator, the user can choose to create lots of additional data points on the L-IOB bus level, device level, and I/O level.

As soon as communication between the L-IOB host and its connected L-IOB devices is established, the corresponding data points are available for the application running on the L-IOB host. Observe that some L-IOB data points are read-only (e.g. ProductCode) and some are write-only (e.g. PinCode). For data points which can be read and written, value data points will be created on the L-IOB host.

### 10.6.1 Bus specific Data Points

The bus specific data point names are preceded with the L-IOB bus number, e.g. ‘L1\_FirstNonDCIndex’.

- **FirstNonDCIndex**: see Section 10.2.1.
- **MaxDeviceCount**: maximum number of L-IOB devices on this L-IOB bus (8 or 24).

### 10.6.2 Device specific Data Points

The device specific data point names are preceded with the L-IOB bus number and L-IOB station ID, e.g. ‘L1\_2\_ProductCode’.

- **ProductCode**: see Section 10.2.5.
- **DeviceName**: see Section 10.2.6.
- **NID**: see Section 10.2.11.
- **StationID**: see Section 10.2.1.
- **PinCode**: see Section 10.2.5.
- **ErrorMask**: Contains the last error code of this L-IOB device:
  - 0 ... OK (no error)
  - 23 ... Wrong L-IOB device type
  - 25 ... Firmware version too low

- 28 ... Address mismatch (device not correctly commissioned)
  - 43 ... Device is unconfigured
  - 49 ... Device needs configuration run
  - 51 ... Station ID mismatch
  - 71 ... LIOB-10x device on wrong position in daisy chain
- **CfgExists**: flag is set if configuration for this device exists (always set).
  - **Enabled**: flag is set if this device is enabled.
  - **Online**: flag is set if this device is online.
  - **NotDetected**: flag is set if this device could not be detected.
  - **EnableUpgrade**: flag is set if firmware upgrade is allowed for this device.
  - **AlternativeUnit**: flag is set if this device shows US units (instead of SI units).
  - **ManualMode**: flag is set if at least one I/O is in manual mode.
  - **FMWVersion**: firmware version of this device.
  - **FMWTimestamp**: firmware build time stamp (date and time) of this device.
  - **Serial**: serial number of this device.
  - **LastRebootTimestamp**: date and time of last reboot of this device.
  - **SystemTemp**: current system temperature of the device.
  - **SystemVoltage**: current supply voltage of this device.
  - **CPUload**: current CPU load of this device.

### 10.6.3 I/O specific Data Points for Inputs

The I/O specific data point names are preceded with the L-IOB bus number, L-IOB station ID, and I/O terminal name, e.g. 'L1\_2\_UI5\_Input'.

- **Input**: current value of the input as measured and interpreted by the L-IOB device, if the operating mode is set to "Auto". This data point will go offline if the L-IOB device is detected offline by the L-IOB host. It will go out-of-service, if the sensor is detected disconnected by the L-IOB device. If the operating mode is set to a mode different than "Auto", the input value will be set to the corresponding manual, override, or default value, see Section 10.3.11.
- **IOStatus**: current status of input. This data point will go from "OK" to "Disconnected", if the sensor is disconnected.
- **PulseTime**: time between the last two pulses for signal interpretation "Pulse Count" or "Physical Unit Count" (see Section 10.3.4). This can be used to quickly detect a change of the derivative of the physical value, e.g. a change of the electric power if the measured physical value is electric energy. Note that the PulseTime data point must be activated via the PulseTime flag, see Section 10.3.14.
- **OperatingMode**: see Section 10.3.11.

- **OverrideValue:** see Section 10.3.11.
- **DefaultValue:** see Section 10.3.11.
- **Offset:** see Section 10.3.22.
- **MinValue:** see Section 10.3.23.
- **MaxValue:** see Section 10.3.23.
- **HoldTime:** see Section 10.3.28.
- **DebounceTime:** see Section 10.3.28.
- **PulseCountInit:** when this data point is written, the pulse count is reset to the written value. This applies to inputs with Interpretation “Pulse Count” or “Physical Unit Count”, see Section 10.3.4.

#### 10.6.4 I/O specific Data Points for Outputs

The I/O specific data point names are preceded with the L-IOB bus number, L-IOB station ID, and I/O terminal name, e.g. “L1\_1\_DO4\_Output”.

- **Output:** current value of the output as set by the L-IOB host application. This data point will go offline if the L-IOB device is detected offline by the L-IOB host.
- **Feedback:** the feedback data point will always be set to the current physical value of the output. See Section 10.3.11 for details.
- **IOStatus:** current status of output. This data point always has the value “OK”.
- **RunHours:** total time the digital output was switched on.
- **EnergyCount:** energy consumption of the device or appliance (e.g. lamp) connected to the output, see also Section 10.3.32.
- **SwitchCycles:** Number of switching cycles of the digital output. This is useful for estimating the expected remaining life time of a relay. Observe that this data point is never reset, not even by a reset to factory defaults, see Section 4.6.3.
- **OperatingMode:** see Section 10.3.11.
- **OverrideValue:** see Section 10.3.11.
- **DefaultValue:** see Section 10.3.11.
- **Offset:** see Section 10.3.22.
- **MinValue:** see Section 10.3.23.
- **MaxValue:** see Section 10.3.23.
- **PWMPeriod:** see Section 10.3.31.
- **RunHoursInit:** when this data point is written, the RunHours data point is reset to the written value.

- **EnergyCntInit:** when this data point is written, the EnergyCount data point is reset to the written value.
- **NominalPower:** see Section 10.3.32.

### 10.6.5 Parameters

Some bus, device, and I/O specific configuration properties are available as parameters. The parameter data points are exported via a parameter file, which contains the entire set of current parameter values including meta-information for external tools to display parameter data in a human-readable way. The LWEB-900 parameter view (see Figure 66) can process such parameter data points and manage them for a large number of devices. L-IOB parameters can easily be set for multiple L-IOB host devices in a system without having to change the L-IOB host project for each L-IOB host in the Configurator. For more information on how to manage parameters on your devices please refer to the LWEB-900 manual.

Device	Parameter	Parameter														
		IOOperationMode	IOName	IOOverrideValue	IODefault	IOTemperature	IOOffset	IOMinValue	IOMaxValue	IOUTC_Pm	IOUTC_Th	IOUTC_B	IOreadTime	IOwriteTime	IOPower	
01 LINX-AB:/LIOB																
02 LINX-AB:/LIOB/LIOB1/UI1	Normal	UI_Custom_N...	0 °C	0 °C	Cust...	0 °C	15 °C	40 °C	100...	25 °C	1000	0 s	0 s			
03 LINX-AB:/LIOB/LIOB1/UI2	Normal	UI_PT1000	0 °C	0 °C	PT1...	0 °C	15 °C	40 °C	100...	25 °C	1000	0 s	0 s			
04 LINX-AB:/LIOB/LIOB1/UI3	Normal	UI_NTC10K	0 °C	0 °C	NTC...	-5 °C	15 °C	40 °C	100...	25 °C	1000	0 s	0 s			
05 LINX-AB:/LIOB/LIOB1/UI4	Normal	UI_NTC1K8	0 °C	0 °C	NTC...	0 °C	15 °C	40 °C	100...	25 °C	1000	0 s	0 s			
06 LINX-AB:/LIOB/LIOB1/UI5	Normal	UI_Ni1000	0 °C	0 °C	Ni10...	0 °C	15 °C	40 °C	100...	25 °C	1000	0 s	0 s			
07 LINX-AB:/LIOB/LIOB1/UI6	Normal	UI_Linear	0 °C	0 °C	Linear	0 °C	15 °C	40 °C	100...	25 °C	1000	0 s	0 s			
08 LINX-AB:/LIOB/LIOB1/UI7	Normal	UI_Frequency	0 Hz	0 Hz	Freq...	0 Hz	0 Hz	10 Hz	100...	25 °C	1000	5 s	1 s			
09 LINX-AB:/LIOB/LIOB1/UI8	Normal	UI_Trans_Table	0 °C	0 °C	Tran...	0 °C	15 °C	40 °C	100...	25 °C	1000	5 s	1 s			
10 LINX-AB:/LIOB/LIOB1/DI1	Normal	DI_Digital	OP...	OP...	Digital	OP...	OP...	CLOS...	100...	25 °C	1000	0 s	0 s			
11 LINX-AB:/LIOB/LIOB1/DI2	Normal	DI_Pulse_Cnt	0	0	Puls...	0	0	4,2949...	100...	25 °C	1000	0 s	0 s			
12 LINX-AB:/LIOB/LIOB1/AO1	Normal	AO_Digital	OP...	OP...	Digital	OP...	OP...	CLOS...						1 s	0.5 s	0 W
13 LINX-AB:/LIOB/LIOB1/AO2	Normal	AO_Analog	0 V	0 V	Anal...	0 V	0 V	10 V						1 s	0.5 s	0 W
14 LINX-AB:/LIOB/LIOB1/DO1	Normal	DO_Digital	OP...	OP...	Digital	OP...	OP...	CLOS...						1 s	0.5 s	0 W
15 LINX-AB:/LIOB/LIOB1/DO2	Normal	DO_PwM	0 %	0 %	PwM	0 %	0 %	100 %						1 s	0.5 s	0 W
16 LINX-AB:/LIOB/LIOB1/DO3	Manual	manual	OP...	OP...	Digital	OP...	OP...	CLOS...						1 s	0.5 s	0 W
17 LINX-AB:/LIOB/LIOB1/DO4	Override	override	CL...	OP...	Digital	OP...	OP...	CLOS...						1 s	0.5 s	0 W
18 LINX-AB:/LIOB/LIOB1/DO5	Disabled	disabled	OP...	OP...	Digital	OP...	OP...	CLOS...						1 s	0.5 s	0 W

Figure 66: LWEB-900 Parameter View

When changing parameters on the device or via the LWEB-900 parameter view, they are out of sync with their default values in the configuration. As a default it assumed that parameters are managed by LWEB-900 and the Configurator does not download and overwrite parameter values to the device.

The project settings can be changed to have the Configurator manage parameters (see L-INX user manual [1] or LIOB-x8x user manual [2]). In this mode the Configurator provides a mechanism to resolve this conflict and to merge those changed parameters back into the configuration. This is accomplished in the parameter merge dialog when uploading or downloading the configuration (see Figure 67). The user can select a resolution in the drop-down box. The arrow indicates in which direction the parameter values shall be copied: Copy value from device to default value, write default value to the device or NONE to leave configuration and value on device separate.

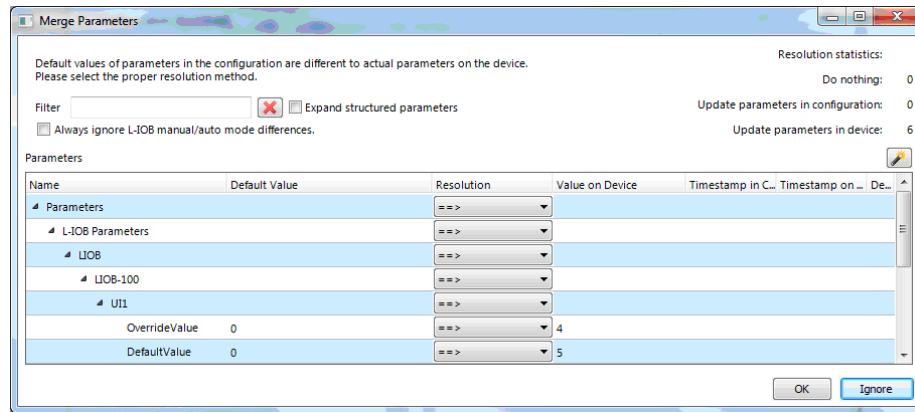

Figure 67: Parameter merge dialog.

When selecting a resolution on single parameters it affects only those parameters. When selecting a resolution on a folder it affects all data points under this folder. Click on **Ignore** to skip the parameter merge process.

L-IOB parameters are not managed by LWEB-900 and the Configurator always tries to merge L-IOB parameters that have been changed on the device. Frequent changes made to manual/auto mode can be ignored by checking **Always ignore L-IOB manual/auto mode differences**.

## 10.7 Data Points (LONMARK® Mode)

This section describes the network data points provided by a LIOB-15x or LIOB-45x device in LONMARK® or Non-ECS device mode. Since the L-IOB device acts as a common CEA-709 node in these device modes, the data points are represented as network variables (NVs) and configuration properties (CPs). These NVs and CPs are organized in functional blocks which form the CEA-709 interface of the node. All CPs are implemented as files (CPT, CPC, CPV files) and configured in the L-INX Configurator Software. The description in the following sections provides documentation of the CPs just for the sake of completeness, it is not meant to suggest manual CP setup (without the Configurator Software).

### 10.7.1 Device Global Configuration Properties

The L-IOB device has some device global configuration properties not mapped to a functional block:

- **UCPTioDeviceExt** (structure): This CP is reserved for future use.
- **UCPTioPinCode** (unsigned): This CP represents the PIN code of the L-IOB device, see Section 10.2.7.
- **UCPTmsText** (array of structures): This CP is reserved for future use.
- **UCPTtermDescr** (array of structures): This CP contains the names and numbers of all terminals.
- **UCPTtransTbl** (array of structures): This CP contains the translation tables of the L-IOB device, see Section 10.2.12.

### 10.7.2 Node Object (UFPTnodeObject, FPT Key #0)

The L-IOB device provides a node object conforming to the LONMARK® guidelines. The functional block type for the node object is derived from the Standard Functional Profile Template **SFPTnodeObject** (FPT Key #0) and was extended to the Template



**UFPTnodeObject.** The essential NVs and CPs of the functional profile are depicted in Figure 68.

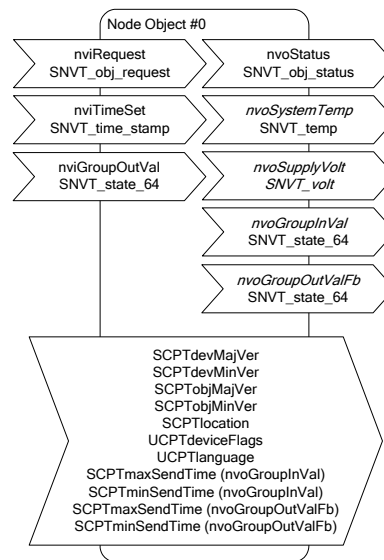

Figure 68: Node Object

- **nviRequest** (SNVT\_obj\_request) / **nvoStatus** (SNVT\_obj\_status): The Node Object accepts the following commands via nviRequest: RQ\_NORMAL, RQ\_UPDATE\_STATUS, RQ\_REPORT\_MASK, RQ\_ENABLE, RQ\_DISABLED, RQ\_RMV\_OVERRIDE, RQ\_REMOTE\_CTRL, RQ\_MANUAL\_CTRL, RQ\_OVERRIDE.
- **SCPTlocation** (SNVT\_str\_asc): This CP represents the name of the device, see Section 10.2.6.
- **UCPTdeviceFlags** (unsigned quad): This CP allows setting some device specific flags:
  - UCPT\_DEVICE\_FLAGS\_US (0x00200000): for displaying US units instead of SI units in the L-IOB LCD Display, see Section 10.2.8.
  - UCPT\_DEVICE\_FLAGS\_SET\_ACC (0x10000000): this flag must be set to be able to set back counter values (energy count, run hours, and live values for interpretation ‘physical unit count’ or ‘pulse count’). During normal operation, it must be reset to ensure that commissioning the device does not automatically set back the counter values.
- **UCPTlanguage** (enumeration type): This CP allows setting the language in the L-IOB LCD Display:
  - UCPT\_LANGUAGE\_UNDEF (0): default language / leave language as is,
  - UCPT\_LANGUAGE\_ENG (1): English,
  - UCPT\_LANGUAGE\_GER (2): German,
- **nviTimeSet** (SNVT\_time\_stamp): When writing to this NV, the system time is set. The time value is interpreted as local time.
- **nvoSystemTemp** (SNVT\_temp): This NV can be used to poll the system temperature of the device. It does not send updates and must be polled.
- **nvoSupplyVolt** (SNVT\_volt): This NV can be used to poll the supply voltage of the device. It does not send updates and must be polled.
- **nvoGroupInVal** (SNVT\_state\_64): This NV combines the binary values of all inputs with interpretation ‘digital’ or ‘occupancy’. The mapping of its bits is documented in

Section 10.7.4. The NV has mapped a SCPTmaxSendTime and a SCPTminSendTime CP, see Section 10.2.10.

- **nviGroupOutVal** (*SNVT\_state\_64*): This NV allows setting all outputs with interpretation ‘digital’ at once. The corresponding bits for outputs with other interpretations are ignored. The mapping is documented in Section 10.7.4.
- **nvoGroupOutValFb** (*SNVT\_state\_64*): This NV combines the binary feedback values of all outputs with interpretation ‘digital’. The mapping is documented in Section 10.7.4. The NV has mapped a SCPTmaxSendTime and a SCPTminSendTime CP, see Section 10.2.10.

### 10.7.3 Common Terminal Object (UFPTcomTerm, FPT Key #20013)

These functional blocks contain CPs of the common terminals of digital outputs for documentation and display in the L-IOB LCD only. They are configured via the L-INX Configurator Software.

### 10.7.4 Input / Output / Group Mapping

The different LIOB-15x and LIOB-45x Models contain different numbers of input and output functional blocks. When downloading a L-IOB configuration over LNS with the Configurator, these functional blocks will receive display names in the format “TerminalName\_IOname” (e.g. “UI1\_Temp1”) for easy identification in the LNS network management tool. However, the corresponding program name is independent from the I/O name, e.g. “Input[0]” for the functional block of the first input. The following tables show the mapping between the functional blocks and the terminal names (as printed on the L-IOB enclosure) as well as the mapping to the digital group NVs.

LIOB-150 / LIOB-450		
Terminal Name	Functional Block (Program Name)	Digital Group NV mapping
UI1	Input[0]	nvoGroupInVal.bit0
UI2	Input[1]	nvoGroupInVal.bit1
UI3	Input[2]	nvoGroupInVal.bit2
UI4	Input[3]	nvoGroupInVal.bit3
UI5	Input[4]	nvoGroupInVal.bit4
UI6	Input[5]	nvoGroupInVal.bit5
UI7	Input[6]	nvoGroupInVal.bit6
UI8	Input[7]	nvoGroupInVal.bit7
DI1	Input[8]	nvoGroupInVal.bit8
DI2	Input[9]	nvoGroupInVal.bit9
AO1	Output[0]	nviGroupOutVal.bit0 / nvoGroupOutValFb.bit0
AO2	Output[1]	nviGroupOutVal.bit1 / nvoGroupOutValFb.bit1
DO2	Output[2]	nviGroupOutVal.bit2 / nvoGroupOutValFb.bit2
DO3	Output[3]	nviGroupOutVal.bit3 / nvoGroupOutValFb.bit3
DO4	Output[4]	nviGroupOutVal.bit4 / nvoGroupOutValFb.bit4
DO5	Output[5]	nviGroupOutVal.bit5 / nvoGroupOutValFb.bit5
DO6	Output[6]	nviGroupOutVal.bit6 / nvoGroupOutValFb.bit6
DO7	Output[7]	nviGroupOutVal.bit7 / nvoGroupOutValFb.bit7
DO8	Output[8]	nviGroupOutVal.bit8 / nvoGroupOutValFb.bit8

<b>LIOB-150 / LIOB-450</b>		
<b>Terminal Name</b>	<b>Functional Block (Program Name)</b>	<b>Digital Group NV mapping</b>
DO9	Output[9]	nviGroupOutVal.bit9 / nvoGroupOutValFb.bit9

Table 5: LIOB-150/450 Object Mapping

<b>LIOB-151 / LIOB-451</b>		
<b>Terminal Name</b>	<b>Functional Block (Program Name)</b>	<b>Digital Group NV mapping</b>
UI1	Input[0]	nvoGroupInVal.bit0
UI2	Input[1]	nvoGroupInVal.bit1
UI3	Input[2]	nvoGroupInVal.bit2
UI4	Input[3]	nvoGroupInVal.bit3
UI5	Input[4]	nvoGroupInVal.bit4
UI6	Input[5]	nvoGroupInVal.bit5
UI7	Input[6]	nvoGroupInVal.bit6
UI8	Input[7]	nvoGroupInVal.bit7
DI5	Input[8]	nvoGroupInVal.bit8
DI6	Input[9]	nvoGroupInVal.bit9
DI7	Input[10]	nvoGroupInVal.bit10
DI8	Input[11]	nvoGroupInVal.bit11
DI9	Input[12]	nvoGroupInVal.bit12
DI10	Input[13]	nvoGroupInVal.bit13
DI11	Input[14]	nvoGroupInVal.bit14
DI12	Input[15]	nvoGroupInVal.bit15
DI13	Input[16]	nvoGroupInVal.bit16
DI14	Input[17]	nvoGroupInVal.bit17
DI15	Input[18]	nvoGroupInVal.bit18
DI16	Input[19]	nvoGroupInVal.bit19

Table 6: LIOB-151/451 Object Mapping

<b>LIOB-152 / LIOB-452</b>		
<b>Terminal Name</b>	<b>Functional Block (Program Name)</b>	<b>Digital Group NV mapping</b>
UI1	Input[0]	nvoGroupInVal.bit0
UI2	Input[1]	nvoGroupInVal.bit1
UI3	Input[2]	nvoGroupInVal.bit2
UI4	Input[3]	nvoGroupInVal.bit3
UI5	Input[4]	nvoGroupInVal.bit4
UI6	Input[5]	nvoGroupInVal.bit5
AO1	Output[0]	nviGroupOutVal.bit0 / nvoGroupOutValFb.bit0

<b>LIOB-152 / LIOB-452</b>		
<b>Terminal Name</b>	<b>Functional Block (Program Name)</b>	<b>Digital Group NV mapping</b>
AO2	Output[1]	nviGroupOutVal.bit1 / nvoGroupOutValFb.bit1
AO3	Output[2]	nviGroupOutVal.bit2 / nvoGroupOutValFb.bit2
AO4	Output[3]	nviGroupOutVal.bit3 / nvoGroupOutValFb.bit3
AO5	Output[4]	nviGroupOutVal.bit4 / nvoGroupOutValFb.bit4
AO6	Output[5]	nviGroupOutVal.bit5 / nvoGroupOutValFb.bit5
DO1	Output[6]	nviGroupOutVal.bit6 / nvoGroupOutValFb.bit6
DO2	Output[7]	nviGroupOutVal.bit7 / nvoGroupOutValFb.bit7
DO3	Output[8]	nviGroupOutVal.bit8 / nvoGroupOutValFb.bit8
DO4	Output[9]	nviGroupOutVal.bit9 / nvoGroupOutValFb.bit9
DO5	Output[10]	nviGroupOutVal.bit10 / nvoGroupOutValFb.bit10
DO6	Output[11]	nviGroupOutVal.bit11 / nvoGroupOutValFb.bit11
DO7	Output[12]	nviGroupOutVal.bit12 / nvoGroupOutValFb.bit12
DO8	Output[13]	nviGroupOutVal.bit13 / nvoGroupOutValFb.bit13

Table 7: LIOB-152/452 Object Mapping

<b>LIOB-153 / LIOB-453</b>		
<b>Terminal Name</b>	<b>Functional Block (Program Name)</b>	<b>Digital Group NV mapping</b>
UI1	Input[0]	nvoGroupInVal.bit0
UI2	Input[1]	nvoGroupInVal.bit1
UI3	Input[2]	nvoGroupInVal.bit2
UI4	Input[3]	nvoGroupInVal.bit3
UI5	Input[4]	nvoGroupInVal.bit4
UI6	Input[5]	nvoGroupInVal.bit5
AO1	Output[0]	nviGroupOutVal.bit0 / nvoGroupOutValFb.bit0
AO2	Output[1]	nviGroupOutVal.bit1 / nvoGroupOutValFb.bit1
AO3	Output[2]	nviGroupOutVal.bit2 / nvoGroupOutValFb.bit2
AO4	Output[3]	nviGroupOutVal.bit3 / nvoGroupOutValFb.bit3
AO5	Output[4]	nviGroupOutVal.bit4 / nvoGroupOutValFb.bit4
AO6	Output[5]	nviGroupOutVal.bit5 / nvoGroupOutValFb.bit5
DO1	Output[6]	nviGroupOutVal.bit6 / nvoGroupOutValFb.bit6
DO2	Output[7]	nviGroupOutVal.bit7 / nvoGroupOutValFb.bit7
DO3	Output[8]	nviGroupOutVal.bit8 / nvoGroupOutValFb.bit8
DO4	Output[9]	nviGroupOutVal.bit9 / nvoGroupOutValFb.bit9
DO5	Output[10]	nviGroupOutVal.bit10 / nvoGroupOutValFb.bit10

Table 8: LIOB-153/453 Object Mapping

LIOB-154		
Terminal Name	Functional Block (Program Name)	Digital Group NV mapping
UI1	Input[0]	nvoGroupInVal.bit0
UI2	Input[1]	nvoGroupInVal.bit1
UI3	Input[2]	nvoGroupInVal.bit2
UI4	Input[3]	nvoGroupInVal.bit3
UI5	Input[4]	nvoGroupInVal.bit4
UI6	Input[5]	nvoGroupInVal.bit5
UI7	Input[6]	nvoGroupInVal.bit6
PRESS	Input[7]	nvoGroupInVal.bit7
AO1	Output[0]	nviGroupOutVal.bit0 / nvoGroupOutValFb.bit0
AO2	Output[1]	nviGroupOutVal.bit1 / nvoGroupOutValFb.bit1
AO3	Output[2]	nviGroupOutVal.bit2 / nvoGroupOutValFb.bit2
AO4	Output[3]	nviGroupOutVal.bit3 / nvoGroupOutValFb.bit3
DO1	Output[4]	nviGroupOutVal.bit4 / nvoGroupOutValFb.bit4
DO2	Output[5]	nviGroupOutVal.bit5 / nvoGroupOutValFb.bit5
DO3	Output[6]	nviGroupOutVal.bit6 / nvoGroupOutValFb.bit6
DO4	Output[7]	nviGroupOutVal.bit7 / nvoGroupOutValFb.bit7
DO5	Output[8]	nviGroupOutVal.bit8 / nvoGroupOutValFb.bit8
DO6	Output[9]	nviGroupOutVal.bit9 / nvoGroupOutValFb.bit9
DO7	Output[10]	nviGroupOutVal.bit10 / nvoGroupOutValFb.bit10

Table 9: LIOB-154 Object Mapping

### 10.7.5 Input Object (UFPTopenLoopSensor, FPT Key #1)

The functional block type for inputs is derived from the Standard Functional Profile Template **SFPTopenLoopSensor** (FPT Key #1) and was extended to the Template **UFPTopenLoopSensor**. The functional profile is depicted in Figure 69.

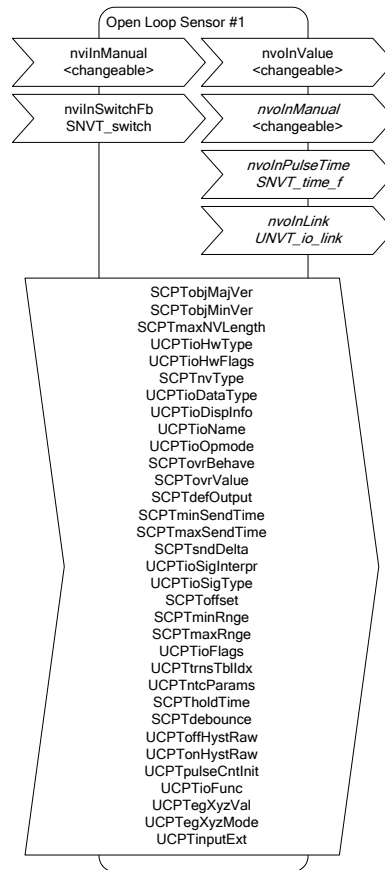

Figure 69: Input Object (Open Loop Sensor)

### 10.7.5.1 Input Network Variables

- **nviInManual** (*changeable*): If this NV is written, the value of the input in manual mode is set. The type of the NV is determined by the SCPTnvType CP, see Section 10.7.5.4.
- **nviInSwitchFb** (SNVT\_switch): This NV provides feedback for the switch mode, see Section 10.4.

### 10.7.5.2 Output Network Variables

- **nvoInValue** (*changeable*): This is the main value of the input. It represents the currently measured value of the input (in auto mode). The type of the NV is determined by the SCPTnvType CP, see Section 10.7.5.4.
- **nvoInManual** (*changeable*): This NV is updated whenever the value of the input in manual mode is changed on the L-IOB LCD Display. The type of the NV is determined by the SCPTnvType CP, see Section 10.7.5.4.
- **nvoInPulseTime** (SNVT\_time\_f): This NV represents the time between the last two pulses for signal interpretation “Pulse Count” or “Physical Unit Count” (see Section 10.3.4). This can be used to quickly detect a change of the derivative of the physical value, e.g. a change of the electric power if the measured physical value is electric energy. Note that the PulseTime NV must be activated via the PulseTime flag, see Section 10.3.14.
- **nvoInLink** (UNVT\_io\_link): This NV is only used internally by the Configurator software and is not required during normal operation.

### 10.7.5.3 Read-Only Configuration Properties

- **SCPTobjMajVer**: major version of object.
- **SCPTobjMinVer**: minor version of object.
- **SCPTmaxNVLength**: maximum length of changeable type NVs (4).
- **UCPTioHwType**: hardware type of physical input, see Section 10.3.2.
- **UCPTioHwFlags**: hardware flags reserved for future use.

### 10.7.5.4 Read/Write Configuration Properties

- **SCPTnvType**: specifies the type of the changeable NVs, see Section 10.3.6.
- **UCPTioDataType**: specifies the high-level data type of the input, see Section 10.3.5.
- **UCPTioDispInfo**: specifies the unit texts for analog inputs or the active/inactive texts for digital inputs (Section 10.3.18), the resolution (Section 10.3.19), alternative unit multiplier and offset (Section 10.3.20), as well as the display on/off symbols (Section 10.3.21).
- **UCPTioName**: specifies the name of the input, see Section 10.3.1.
- **UCPTioOpmode**: specifies the operating mode, see Section 10.3.11.
- **SCPTovrBehave**: specifies the override behavior. This is set by the Configurator software so that in override mode, the override value (**SCPTovrValue**) is used.
- **SCPTovrValue**: specifies the override value, see Section 10.3.11.
- **SCPTdefOutput**: specifies the default value, see Section 10.3.11.
- **SCPTminSendTime**: specifies the minimum send time, see Section 10.3.25.
- **SCPTmaxSendTime**: specifies the maximum send time, see Section 10.3.24.
- **SCPTsndDelta**: specifies the change-of-value property, see Section 10.3.24.
- **UCPTioSigInterpr**: specifies the interpretation, see Section 10.3.4.
- **UCPTioSigType**: specifies the signal type, see Section 10.3.3.
- **SCPToffset**: specifies the offset, see Section 10.3.22.
- **SCPTminRnge**: specifies the minimum value, see Section 10.3.23.
- **SCPTmaxRnge**: specifies the maximum value, see Section 10.3.23.
- **UCPTioFlags**: specifies the invert flag (Section 10.3.13) and the pulse time flag (Section 10.3.14).
- **UCPTtrnsTblIdx**: specifies the index of the translation table, see Section 10.3.26.
- **UCPTntcParams**: specifies the custom NTC parameters, see Section 10.3.27.
- **SCPTholdTime**: specifies the hold time, see Section 10.3.28.
- **SCPTdebounce**: specifies the debounce time, see Section 10.3.28.
- **UCPToffHystRaw**: reserved for future use.
- **UCPTonHystRaw**: reserved for future use.
- **UCPTpulseCntInit**: initializes the pulse count for interpretation 'physical unit count' and 'pulse count'. The `UCPT_DEVICE_FLAGS_SET_ACC` flag must be set in order to perform this operation, see Section 10.7.2.
- **UCPTioFunc**: specifies the I/O function, group number, and sub group number, see Section 10.3.9.

- **UCPTegXyzVal:** these eight configuration properties specify the values to be sent out when the corresponding events occur in switch mode, see Section 10.4.
- **UCPTegXyzMode:** these eight configuration properties specify the modes for sending out values when the corresponding events occur in switch mode, see Section 10.4.
- **UCPTinputExt:** reserved for future use.

### 10.7.6 Output Object (UFPTclosedLoopActuator, FPT Key #4)

The functional block type for outputs is derived from the Standard Functional Profile Template **SFPTclosedLoopActuator** (FPT Key #4) and was extended to the Template **UFPTclosedLoopActuator**. The functional profile is depicted in Figure 70.

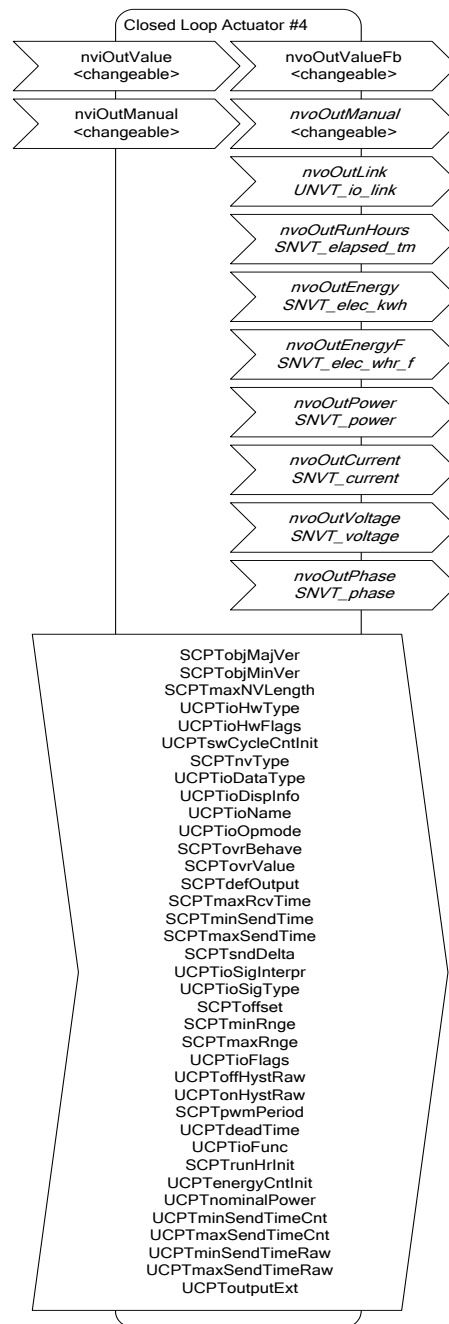

Figure 70: Output Object (Closed Loop Actuator)



### 10.7.6.1 Input Network Variables

- **nviOutValue** (*changeable*): This is the main live value of the output. If it is written, the output changes its physical value accordingly (in auto mode). The type of the NV is determined by the SCPTnvType CP, see Section 10.7.6.4.
- **nviOutManual** (*changeable*): If this NV is written, the value of the output in manual mode is set. The type of the NV is determined by the SCPTnvType CP, see Section 10.7.6.4.

### 10.7.6.2 Output Network Variables

- **nvoOutValueFb** (*changeable*): This is the feedback value of the output. It always represents the current physical value of the output. See Section 10.3.11 for details. The type of the NV is determined by the SCPTnvType CP, see Section 10.7.6.4.
- **nvoOutManual** (*changeable*): This NV is updated whenever the value of the output in manual mode is changed on the L-IOB LCD Display. The type of the NV is determined by the SCPTnvType CP, see Section 10.7.6.4.
- **nvoOutLink** (*UNVT\_io\_link*): This NV is only used internally by the Configurator software and is not required during normal operation.
- **nvoOutRunHours** (*SNVT\_elapsed\_tm*): This NV represents the total time the digital output was switched on.
- **nvoOutEnergy** (*SNVT\_elec\_kwh*): This NV represents the energy consumption of the device or appliance (e.g. lamp) connected to the output, see also Section 10.3.32.
- **nvoOutEnergyF** (*SNVT\_elec\_whr\_f*): same as nvoOutEnergy but using a float type SNVT.
- **nvoOutPower** (*SNVT\_power*): reserved for future use.
- **nvoOutCurrent** (*SNVT\_current*): reserved for future use.
- **nvoOutVoltage** (*SNVT\_voltage*): reserved for future use.
- **nvoOutPhase** (*SNVT\_phase*): reserved for future use.

### 10.7.6.3 Read-Only Configuration Properties

- **SCPTobjMajVer**: major version of object.
- **SCPTobjMinVer**: minor version of object.
- **SCPTmaxNVLength**: maximum length of changeable type NVs (4).
- **UCPTioHwType**: hardware type of physical output, see Section 10.3.2.
- **UCPTioHwFlags**: hardware flags reserved for future use.
- **UCPTswCycleCntInit**: number of switching cycles of the digital output. This CP is useful for estimating the expected remaining life time of a relay. Observe that this data is never reset, not even by a reset to factory defaults, see Section 4.6.3.

### 10.7.6.4 Read/Write Configuration Properties

- **SCPTnvType**: specifies the type of the changeable NVs, see Section 10.3.6.
- **UCPTioDataType**: specifies the high-level data type of the output, see Section 10.3.5.
- **UCPTioDispInfo**: specifies the unit texts for analog outputs or the active/inactive texts for digital outputs (Section 10.3.18), the resolution (Section 10.3.19), alternative unit multiplier and offset (Section 10.3.20).
- **UCPTioName**: specifies the name of the output, see Section 10.3.1.
- **UCPTioOpmode**: specifies the operating mode, see Section 10.3.11.

- **SCPTovrBehave**: specifies the override behavior. This is set by the Configurator software so that in override mode, the override value (SCPTovrValue) is used.
- **SCPTovrValue**: specifies the override value, see Section 10.3.11.
- **SCPTdefOutput**: specifies the default value, see Section 10.3.11.
- **SCPTmaxRcvTime**: specifies the maximum receive time. If no NV update on the main live value is received within this time, the output is set to the default value.
- **SCPTminSendTime**: specifies the minimum send time for the feedback value, see Section 10.3.25.
- **SCPTmaxSendTime**: specifies the maximum send time for the feedback value, see Section 10.3.24.
- **SCPTsndDelta**: specifies the change-of-value property for the feedback value, see Section 10.3.24.
- **UCPTioSigInterpr**: specifies the interpretation, see Section 10.3.4.
- **UCPTioSigType**: specifies the signal type, see Section 10.3.3.
- **SCPToffset**: reserved for future use.
- **SCPTminRnge**: specifies the minimum value, see Section 10.3.23.
- **SCPTmaxRnge**: specifies the maximum value, see Section 10.3.23.
- **UCPTioFlags**: specifies the persistent flag (Section 10.3.12) and the invert flag (Section 10.3.13).
- **UCPToffHystRaw**: specifies the off value, see Section 10.3.30.
- **UCPTonHystRaw**: specifies the on value, see Section 10.3.30.
- **SCPTpwmPeriod**: specifies the PWM period, see Section 10.3.31.
- **UCPTdeadTime**: specifies the dead time, see Section 10.3.8.
- **UCPTioFunc**: specifies the I/O function and group number, see Section 10.3.8.
- **SCPTrunHrInit**: initializes the run hours of the digital output. The UCPT\_DEVICE\_FLAGS\_SET\_ACC flag must be set in order to perform this operation, see Section 10.7.2.
- **UCPTenergyCntInit**: initializes the energy count of the output. The UCPT\_DEVICE\_FLAGS\_SET\_ACC flag must be set in order to perform this operation, see Section 10.7.2.
- **UCPTnominalPower**: specifies the nominal power, see Section 10.3.32.
- **UCPTminSendTimeCnt**: specifies the minimum send time for the run hours and energy count values. This CP is set to 10min by default.
- **UCPTmaxSendTimeCnt**: specifies the maximum send time for the run hours and energy count values. This CP is set to 0 (disabled) by default.
- **UCPTminSendTimeRaw**: reserved for future use.
- **UCPTmaxSendTimeRaw**: reserved for future use.
- **UCPToutputExt**: reserved for future use.

---

## 10.8 Data Points (BACnet Mode)

This section describes the network data points provided by a LIOB-55x in BACnet device mode. Since the L-IOB device acts as a common BACnet node in this device mode, the data points are represented as native BACnet server objects.

### 10.8.1 BACnet Technology

Data points in the BACnet technology are known as BACnet objects. They have a specific type (e.g. analog input or binary output) and a set of properties, which describe the data point more closely. The actual value is stored in the “Present\_Value”.

On the device, there exist two classes of BACnet data points:

- **BACnet server objects (SO):** These BACnet objects configured by the Configurator software to be allocated *locally* on the device. These objects can be accessed by the BACnet building control system or operating workstations. They support COV subscriptions to deliver value changes in an event-driven way.
- **BACnet client mappings (CM):** For certain applications, it is necessary that the device acts as a BACnet client. This functionality can be configured by activating a *client mapping*. Client mappings can be of the type *Poll*, *COV*, *Write*, or *Auto*. This specifies how the BACnet client accesses other BACnet objects on the BACnet network. The *Auto* method determines the best way (poll, COV, or write) to talk with other server objects. *Poll* is used for objects that need to read data from other BACnet objects in a periodic manner. *COV* is used to subscribe for COV at other BACnet objects in order to get updates in an event-driven fashion. *Write* is used to send updates to other BACnet objects. On LIOB-55x devices, it is possible to add client mappings to the automatically created native I/O server objects.

The direction of BACnet server objects deserves a closer look. The direction specified for data points in the Configurator software always refers to the network view of the communication. The definition of input and output objects in BACnet, however, refers to the process view, which is opposite to the network. Therefore, a BACnet analog input (AI) object is modeled as an analog output data point. The direction of client mappings naturally refers to the network communication. Therefore, a write client mapping is represented as an analog output data point.

In BACnet, commandable objects can be written with values at a certain priority. The value with the highest priority is in effect. When revoking a written value, the NULL value is written. This takes back the value. When all written values are withdrawn, the Relinquish\_Default value is in effect.

The default value feature of a data point is mapped to the Relinquish\_Default property for commandable objects. For BACnet objects, which are not commandable, the Present\_Value is initialized with the specified default value.

### 10.8.2 Native BACnet Objects for I/Os

On LIOB-55x devices in BACnet Mode, the L-IOB I/Os are directly exposed to BACnet server objects. Each L-IOB I/O object is represented by one BACnet object. All relevant I/O configuration properties are mapped to corresponding BACnet properties and reflect actual input/output values, I/O status, override/manual values, operating mode, inversion and adhere to all prescribed BACnet functions.

For L-IOB devices, which are connected to a L-IOB host (L-INX or LIOB-48x/58x) via the LIOB-Connect or LIOB-FT/IP bus (L-INX Mode), the native BACnet objects can also optionally be created on the L-IOB host. The option can be switched for each I/O in the Configurator Software.

The type of the created BACnet server object depends on the type of the live value I/O data point. If e.g. a universal input (UI) is used for measuring an analog value, the type of the live value (**Input** data point) will be Double and thus, an Analog Input (AI) BACnet object will be created. Table 10 shows all possible native BACnet object types for I/Os.

I/O	I/O Live Value Type	BACnet Object	Feedback Object
DI/UI	Double	Analog Input (AI) or Accumulator	-
DI/UI	Boolean	Binary Input (BI)	-
DI/UI	LIOB/MagCard	Analog Input (AI)	-
AO/DO	Double	Analog Output (AO)	Analog Input (AI)
AO/DO	Boolean	Binary Output (BO)	-

Table 10: Native BACnet object types for I/Os

For an AO object, an additional AI object is generated as the feedback value object. For BO objects, a separate feedback object is not required, since a feedback value is already included in the BACnet BO object.

For the STId Card Reader mode (see Section 10.5), the I/O live value type of the Card Data input is an array of 40 nibbles which contains the last read Card ID in BCD encoding (LIOB/MagCard). In this case, the first n BCD digits that form a number which can be displayed by a BACnet float are written to the Present\_Value of the created BACnet AI object. An ASCII version of the entire BCD code is written to the Description property of the BACnet object.

For the “Pulse Count” interpretation of inputs (see Section 10.3.4), it is possible to choose between an analog input or an accumulator object in the Configurator. The main difference is that accumulator objects can precisely represent 32-bit meter data while analog objects suffer from a loss of resolution.

When using native BACnet objects for L-IOB outputs, the BACnet priority array concept is used in the I/O operating mode ‘Auto’ for determining the physical output value. Other I/O operating modes (‘Override’, ‘Manual’, ‘Disabled’, see Section 10.3.11) bypass the BACnet priority array. The physical value is determined by the override value or manual value in this case. The following L-IOB live value and configuration property data points, which can be changed at run-time, are exposed to BACnet properties:

- **Input:** For L-IOB inputs in ‘Auto’ mode, the input value is written to the Present\_Value property of the BACnet input object. When switching from another operating mode to ‘Auto’, the current input value is also written.
- **Output:** The Present\_Value of the BACnet object is written to the physical output in ‘Auto’ mode.
- **OperatingMode:**
  - **Auto:** The BACnet object is in normal operation as described above. Out\_of\_service and OVERRIDDEN flags of the BACnet object are cleared.
  - **Override (Input):** The BACnet input object is set to out-of-service. The Present\_Value no longer reflects the physical L-IOB input value. The L-IOB override value is coupled to the Present\_Value and vice-versa. Writing the Out\_Of\_Service property over the BACnet network can turn the ‘Override’ mode on or off (except if in ‘Manual’ or ‘Disabled’ mode).
  - **Override (Output):** The BACnet output object is set to out-of-service. The Present\_Value no longer writes to the L-IOB output value. The L-IOB override value is coupled to priority slot ‘1’ and vice-versa. It is removed from priority slot ‘1’ when returning to ‘Auto’ mode. Writing the Out\_Of\_Service

property over the BACnet network can turn the 'Override' mode on or off (except if in 'Manual' or 'Disabled' mode).

- **Manual:** The BACnet object is set OVERRIDDEN. The Present\_Value reflects the manual value and is decoupled from the L-IOB input value (input) or Priority\_Array (output). Out\_Of\_Service is not set. The Out\_Of\_Service, Present\_Value, and Reliability properties are made read-only and can no longer be written over BACnet. This mode cannot be modified over the BACnet network.
- **Disabled:** The BACnet object is set out-of-service, the OVERRIDDEN flag is set, and the reliability is set to 'no fault detected'. The Out\_Of\_Service, Present\_Value, and Reliability properties are made read-only and can no longer be written over BACnet. This mode cannot be modified over the BACnet network.
- **OverrideValue:** In 'Override' mode this value is written to the Present\_Value of the BACnet object at priority '1'. When entering 'Override' mode, the current override value is written. When leaving 'Override' mode, NULL is written at priority '1' for output objects and nothing is done for input objects. For input objects in 'Override' mode, the override value is updated by the Present\_Value when written over BACnet.
- **ManualValue:** In 'Manual' mode, the L-IOB manual value is written to the Present\_Value property of the BACnet object. The Present\_Value cannot be written over BACnet in 'Manual' mode.
- **DefaultValue:** The L-IOB default value is written to the Relinquish\_Default property of the BACnet object and vice-versa, if it exists.
- **Invert:** This L-IOB parameter is written to the Polarity property of BACnet BO and BI objects and vice-versa.
- **IOStatus:** The I/O status is reflected in the Reliability property of the BACnet object:
  - NO\_FAULT\_DETECTED: If the I/O does not report any error.
  - NO\_OUTPUT/NO\_SENSOR: If an output or sensor failure is detected.
  - COMMUNICATION\_ERROR: If the L-IOB host reports a communication error.
  - UNRELIABLE\_OTHER: For all other problems.
- **Feedback:** For L-IOB outputs in digital mode, the feedback value is written to the Feedback\_Value property of the BACnet BO object. For L-IOB outputs in analog mode, the feedback value is written to the dedicated BACnet AI feedback object.
- **MinValue, MaxValue, Resolution:** For analog BACnet objects and BACnet Accumulator objects, these L-IOB configuration properties are written to the corresponding BACnet properties when they change. For a BACnet Accumulator object, the L-IOB Resolution is mapped to the BACnet Scale property. The BACnet properties are read-only from the BACnet network.
- **I/O Name and Description:** Initially, the BACnet server object name and description are both set to e.g. 'L1\_1\_UI1' (for UI1). In the Configurator, the BACnet server object name and description can later be modified manually or synchronized with the current I/O name and description.
- **PulseCountInit:** If the BACnet object type is Accumulator and this L-IOB configuration property is written (to reset the pulse counter), the value is also written to the Value\_Set property of the BACnet Accumulator object and vice versa.

---

## 10.9 Default Configuration

Every L-IOB device is shipped with a default I/O configuration, which can be used right away. This configuration is the same in every device mode (see Section 5.1) and is dependent on the hardware type (see Section 10.3.2) of the corresponding I/O:

- **Universal Inputs (UI):** measure voltage between 0V and 10V. The interpretation is 'Linear' with MinValue 0V and MaxValue 10V. Network variables of type SNVT\_volt\_f are used in LONMARK® Mode.
- **Digital Inputs (DI):** act as switch inputs. The interpretation is 'Digital'. Network variables of type SNVT\_switch are used in LONMARK® Mode.
- **Pressure Sensors (PRESS):** measure pressure between 0Pa and 500Pa (Pascal). The interpretation is 'Linear' with MinValue 0Pa and MaxValue 500Pa. Network variables of type SNVT\_press\_f are used in LONMARK® Mode.
- **Analog Outputs (AO):** deliver a voltage between 0V and 10V according to the given percentage level. The interpretation is 'Analog' with MinValue 0V and MaxValue 10V. Network variables of type SNVT\_lev\_percent are used in LONMARK® Mode.
- **Digital Outputs (DO):** relays or triacs close when the given value goes active and open when the value goes inactive. The interpretation is 'Digital'. Network variables of type SNVT\_switch are used in LONMARK® Mode.

Observe that LIOB-55x devices in BACnet Mode need an initial configuration from the Configurator software to be accessible over the BACnet/IP network.

# 11 The Configurator

This Chapter gives step-by-step instructions on how to commission a L-IOB I/O module, create a data point configuration in the L-INX Configurator, and how to manage and use those data points. Please refer to the L-INX User Manual [1] for general information on the Configurator Software.

---

## 11.1 Software Installation and General Settings

The L-INX Configurator must be used to setup the data point configuration of the L-IOB I/O modules.

System requirements:

- Windows XP, Windows 2003 Server, Windows Vista, Windows 7, Windows 2008 Server, Windows 8 (64 bit), Windows 2012 Server.

The L-INX Configurator can be downloaded from the LOYTEC Web site <http://www.loytec.com>. When asked for the type of installation, there are two options to choose from. Select **Typical** to install the required program files.

In menu **Settings / Project Settings / General / L-IOB unit settings** it is possible to setup the usage of physical units:

- **Display SI/US units:** switches the display of physical values in the LCD UI of the L-IOB devices between SI (primary) and US (secondary) units. The actual SI and US units can be explicitly chosen for each I/O in the I/O object parameter list, see Section 11.2.2.
- **Datapoints use SI/US units:** switches the physical units of the L-IOB host data points between SI (primary) and US (secondary) units. This means that the values of the data points on the L-IOB host are actually processed in the chosen units.

---

## 11.2 Configuring L-IOB Modules (L-INX Mode)

This section only applies to LIOB-10x models, LIOB-15x models in LIOB-FT device mode, and LIOB-45x/55x models in LIOB-IP device mode. Please refer to Section 5.1 for more information on L-IOB device modes. It is assumed in the following sections that the Configurator Software is started on a L-IOB host model capable of connecting LIOB-Connect, LIOB-FT, or LIOB-IP devices (L-IOB tab available in the software).

## 11.2.1 Add L-IOB Modules

L-IOB modules are added to the L-IOB host configuration in the Configurator. This configuration determines, which L-IOB modules are connected to the L-IOB host in which I/O configuration.

### To Add a L-IOB Module

1. In the Configurator change to the **L-IOB** tab.

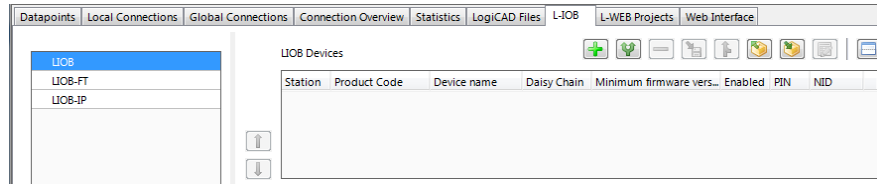



Figure 71: L-IOB tab in the Configurator

2. In the LIOB Configuration tree on the left, select the **LIOB** (LIOB-Connect), **LIOB-FT**, or **LIOB-IP** bus.
3. Click the **Add Device(s)** button .
4. In the file requestor, select a LIOB device template for your L-IOB model, e.g., liob100.xml. The L-IOB device appears in the **LIOB Devices** list.

Station	Product Code	Device name	Daisy Chain	Minimum firmware vers...	Enabled	PIN	NID
1	LIOB-100	LIOB-100	<input checked="" type="checkbox"/>	2.2	<input checked="" type="checkbox"/>		000000000000

5. Optionally, double-click on the **Device name** and enter a descriptive device name, e.g. 'MyLIOB'.

Station	Product Code	Device name
1	LIOB-100	MyLIOB



6. To add more L-IOB devices repeat the add device step. Use the **Up** and **Down** button to organize the L-IOB devices in the order as they are connected to the L-IOB host. Station 1 is the first L-IOB, station 2 the second, and so on.
7. Observe that the **Device parameters** table (below the LIOB device table) lists all device configuration properties and also life values that can be exposed as L-IOB data points. These L-IOB data points in turn can be exposed as OPC data points as well as input and/or output data points in the logic program. By default, no device data points are created. Using the checkboxes in the **DP Create** column of the **Device parameters** table, device configuration properties and life values can be exposed as L-IOB data points. Using the checkboxes in the **OPC**, **PLC In**, and **PLC Out** columns, it is possible to select which of the created data points shall be exposed as OPC data points, logic program input data points, and logic program output data points.

Nr.	DP Create	OPC	PLC In	PLC Out	Parameter value	Parameter name	Description
0	<input type="checkbox"/>	<input type="checkbox"/>	<input type="checkbox"/>	<input type="checkbox"/>	LIOB-100	ProductCode	Product code of L-IOB device
1	<input type="checkbox"/>	<input type="checkbox"/>	<input type="checkbox"/>	<input type="checkbox"/>	LIOB-100	DeviceName	Device name
2	<input type="checkbox"/>	<input type="checkbox"/>	<input type="checkbox"/>	<input type="checkbox"/>	000000000000	NID	Node ID
3	<input type="checkbox"/>	<input type="checkbox"/>	<input type="checkbox"/>	<input type="checkbox"/>	1	StationID	Station ID for device enumeration
4	<input type="checkbox"/>	<input type="checkbox"/>	<input type="checkbox"/>	<input type="checkbox"/>		PinCode	PIN code (empty or 0 to disable)
5	<input type="checkbox"/>	<input type="checkbox"/>	<input type="checkbox"/>	<input type="checkbox"/>		FMWVersion	Firmware version
6	<input type="checkbox"/>	<input type="checkbox"/>	<input type="checkbox"/>	<input type="checkbox"/>		FMWTimestamp	Firmware timestamp
7	<input type="checkbox"/>	<input type="checkbox"/>	<input type="checkbox"/>	<input type="checkbox"/>		Serial	Serial number
8	<input type="checkbox"/>	<input type="checkbox"/>	<input type="checkbox"/>	<input checked="" type="checkbox"/>		Enabled	Enabled flag



- Refer to Section 10.2 for more information on the other device specific configuration properties.

## 11.2.2 Configure I/Os

Once a L-IOB device has been added to a configuration, the I/Os have a default configuration. To adapt the I/Os to the specific needs in a project they can be freely configured. Note that certain changes to the I/O configuration must be committed before proceeding with other tasks. This can be done explicitly by clicking **Commit member changes** . Otherwise, the user will be requested to commit by the Configurator. Changes can be canceled by clicking **Cancel member changes** .

### To Configure I/Os

- Select a L-IOB device in the LIOB Configuration tree.

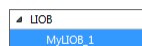

- The L-IOB tab displays the I/Os available on that L-IOB device in the **Inputs / Outputs** list.

Inputs / Outputs					
Nr	TerminalNr	Terminal	Name	Hardware type	DP count
1	1	UI1	UI1	IN Analog/Digital 10V	22
2	2	GND12	GND UI1-UI2	IN Analog/Digital 10V	
3	3	UI2	UI2	IN Analog/Digital 10V	22
4	4	UI3	UI3	IN Analog/Digital 10V	22

- To adapt the I/O name, double-click the name in the **Name** column and edit it, e.g., 'RoomTemp'.

Nr	TerminalNr	Terminal	Name	Hardware type
1	1	UI1	RoomTemp	IN Analog/Digital



- Select (or multi-select) an I/O in the **Inputs/Outputs** list and observe the **Object parameters** list below. These parameters can be used to configure the I/O.

Object parameters									
Nr	DP Create	OPC	PLC In	PLC Out	Parameter name	Parameter value	Unit	Range	Description
0	<input type="checkbox"/>	<input type="checkbox"/>	<input type="checkbox"/>	<input type="checkbox"/>	Name	RoomTemp			Terminal name
1	<input type="checkbox"/>	<input type="checkbox"/>	<input type="checkbox"/>	<input type="checkbox"/>	HardwareType	IN Analog/Digital			Terminal type
2	<input type="checkbox"/>	<input type="checkbox"/>	<input type="checkbox"/>	<input type="checkbox"/>	SignalType	Voltage 0-10V			Type of the input/output signal

- For example, change the **SignalType** of the input UI1 to 'Resistance'.
- Note that the object configuration properties may change when changing the signal type or interpretation. For detailed information on available configuration properties and their dependencies refer to Section 10.3. In this example you may now edit the **Interpretation** to 'NTC10K', which will allow connecting an NTC temperature sensor to the input.

SignalType	Resistance
Interpretation	NTC10K







- Observe that the **Object parameters** table lists all I/O configuration properties and also life values that can be exposed as L-IOB data points. These L-IOB data points in turn can be exposed as OPC data points as well as input and/or output data points in the logic program. Only the basic data points of each I/O (input, output, feedback) are created by default. Using the checkboxes in the **DP Create** column of the **Objects parameters** table, additional configuration properties and life values can be exposed as L-IOB data points. Using the checkboxes in the **OPC**, **PLC In**, and **PLC Out** columns, it is possible to select which of the created data points shall be exposed as OPC data points, logic program input data points, and logic program output data points.

8. Native BACnet objects can be created in the L-IOB host (if it supports BACnet) using the **BACnet Object** checkbox. For inputs with interpretation “Pulse Count”, it is possible to choose between the **BACnet Object Type** “Analog Input” and “Accumulator”. The BACnet server object names and descriptions will initially receive unique I/O names as described in Section 10.8.2. They can be set to the current I/O names and descriptions by using the button **Set BACnet Names** .
9. I/Os of the same hardware type can be copied using the **Copy selected object**  and **Paste to selected object(s)**  buttons. This can also be done between different L-IOB devices.

### 11.2.3 Manage L-IOB Configurations

L-IOB configurations can be managed by the user. One may duplicate the device for repeated use in the project. Also, a new template may be generated from the L-IOB configuration, which can be re-used in other projects.

#### To Manage L-IOB Configurations

1. Select the **LIOB**, **LIOB-FT**, or **LIOB-IP** folder in the LIOB Configuration tree.
2. In the **LIOB Devices** list, select a configured L-IOB device or use multi-select to select multiple devices at a time.
3. Click on the **Duplicate Device(s)** button . This duplicates the selected L-IOB devices and all I/O configurations.
4. Unneeded devices may be deleted again by clicking the **Delete Device(s)** button .
5. To export a new template for a L-IOB configuration click the **Export device template** button . No multi-select is possible for this operation. In the file save dialog, enter a new L-IOB template file name and store it. This file can then be used in a different project using the **Add Device(s)** button .
6. Existing configurations can be updated with new L-IOB templates by using the **Upgrade Template** button . This can be used e.g. to migrate new functions which were not yet available in earlier template versions. It is highly recommended to backup the original L-IOB host project before upgrading templates. After upgrading the template, a log is displayed, which shows all information about the upgrade process. Please carefully review this log before using the updated configuration.
7. Another way of managing L-IOB configurations is using terminal configurations. A terminal configuration can be created from an I/O object in the **Inputs / Outputs** list by using the **Export object to disc**  button next to the list. In this case, only the configuration of this I/O is stored in an XML file. Terminal configurations can be imported (to one or multiple I/Os of the same hardware type) by using the **Import object from disc**  button.
8. These terminal configurations can also be used to configure the I/Os of all L-IOB devices in a L-IOB host project. This is done by manually creating a CSV file with one line per I/O and the following eight columns:
  - a. Bus: either “LIOB” or “LIOB-FT”. If the field in this column starts with “#”, the whole line is ignored. This can be used e.g. for a column header line or other comment lines in the CSV file.
  - b. Station ID: station ID of the L-IOB device (1-8) within the bus.

- c. Device Template: file name of the device template, e.g. “liob100.xml”.
- d. Device Name: user defined name of the device, e.g. “LIOB\_Heating”.
- e. NID: specifies the Node ID (see Section 10.2.11) of the device if already known. Otherwise, the field is left blank.
- f. Terminal: the terminal identifier as listed in the column “Terminal” of the **Inputs / Outputs** list, e.g. “UI1”.
- g. Terminal Name: user defined name of the I/O, e.g. “Temperature A”
- h. Terminal Template: file name of the terminal configuration (which was stored using **Export object to disc** ) , e.g. “Humid\_Sensor.xml”.
- i. Description: user defined description of the I/O.
- j. Favorite Name: optional name of a data point in the folder “Favorites”. If this column entry exists for an I/O, an additional data point (input or output value) in the “Favorites” folder of the L-IOB host will be created.
- k. OPC: specifies if the Favorite data point shall be OPC exposed (‘true’) or not (‘false’).
- l. PLC In: specifies if the Favorite data point shall be exposed as a logic program input data point (‘true’) or not (‘false’).
- m. PLC Out: specifies if the Favorite data point shall be exposed as a logic program output data point (‘true’) or not (‘false’).



An example of such a CSV file is shown here:

```
#Bus;St.ID;Dev.Template;Dev.Name;NID;Terminal;Term.Name;Term.Template;Description;FavoriteName
LIOB;1;liob100.xml;LIOB_Heating;;UI1;TempA;NTC.xml;TempRoomA;FavTA;true;false;false
LIOB;1;liob100.xml;LIOB_Heating;;UI2;TempB;NTC.xml;TempRoomB;FavTB;true;true;false
LIOB;2;liob100.xml;LIOB_Cooling;;UI1;HumidA;Humid_Sensor.xml;HumidRoomA;FavHA;false;false;false
LIOB;2;liob100.xml;LIOB_Cooling;;UI2;HumidB;Humid_Sensor.xml;HumidRoomB;FavHB;false;true;false
LIOB-FT;1;liob150.xml;LIOB_Shades;;AO1;MotorUp;Motor.xml;MotorUpDirection;FavMU;false;false;false
LIOB-FT;1;liob150.xml;LIOB_Shades;;AO2;MotorDn;Motor.xml;MotorDnDirection;FavMD;true;true;true
```

The terminal configurations “NTC.xml”, “Humid\_sensor.xml”, and “Motor.xml” would have to be present in the same folder as the CSV file. The file would e.g. look like this in MS Excel:

	A	B	C	D	E	F	G	H	I	J	K	L	M
1	#Bus	St.ID	Dev.Template	Dev.Name	NID	Terminal	Term.Name	Term.Template	Description	FavoriteName	OPC	PLCIn	PLCOut
2	LIOB	1	liob100.xml	LIOB_Heating		UI1	TempA	NTC.xml	TempRoomA	FavTA	true	false	false
3	LIOB	1	liob100.xml	LIOB_Heating		UI2	TempB	NTC.xml	TempRoomB	FavTB	true	true	false
4	LIOB	2	liob100.xml	LIOB_Cooling		UI1	HumidA	Humid_Sensor.xml	HumidRoomA	FavHA	false	false	false
5	LIOB	2	liob100.xml	LIOB_Cooling		UI2	HumidB	Humid_Sensor.xml	HumidRoomB	FavHB	false	true	false
6	LIOB-FT	1	liob150.xml	LIOB_Shades		AO1	MotorUp	Motor.xml	MotorUpDirection	FavMU	false	false	false
7	LIOB-FT	1	liob150.xml	LIOB_Shades		AO2	MotorDn	Motor.xml	MotorDnDirection	FavMD	true	true	true

The CSV file can finally be imported using the **Import terminal configuration** button .

9. It is also possible to export such a terminal configuration from an existing project using the **Export terminal configuration** button . After choosing a file location and name, the user will be asked if only customized objects shall be exported. If this option is enabled, only L-IOB devices with custom I/Os (where changes have been made) will be exported.
10. To setup translation tables for certain I/O interpretation modes, click the **Edit translation tables** button .

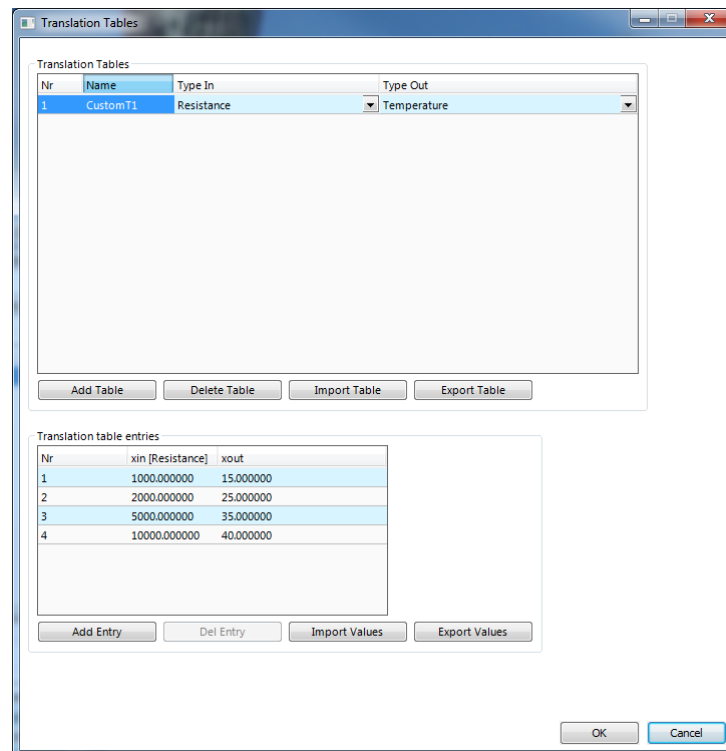

Figure 72: L-IOB Translation Tables

11. You can add and delete tables using the buttons **Add table** and **Delete table**. The data types for the **xin** and **xout** columns of the table can be setup in **Type In** and **Type Out**. In the **Translation table entries** list, you can enter the **xin** and **xout** values. The translation is done (with linear interpolation) from measured **xin** values to **xout** values which are used for the L-IOB data points. Further, the table values can be exported and imported (CSV files) with **Import Values** and **Export Values**. Entire tables (including table name and type) can be exported and imported with **Import Table** and **Export Table**. Tables of some standard temperature sensors are installed with the Configurator in the subfolder “LIOB\tables”.

### 11.2.4 Using L-IOB Data Points

The L-IOB I/Os are exposed to data points on the L-IOB host. These data points comprise the present value of the I/O as well as status and configuration data (depending on the “DP Create” settings, see Section 11.2.2). When adding a L-IOB device to the device configuration, a folder appears in the data point manager tab of the Configurator. Figure 73 shows an example for a LIOB-100.

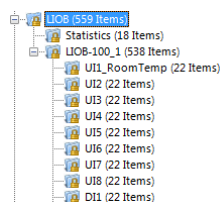

Figure 73: L-IOB folder in the data point manager

Under the L-IOB device folder there exist sub-folders for each I/O on the module. When selecting any of the folders, the data point list shows all data points in the scope of that folder. The data points on the LIOB folder provide data for the entire L-IOB bus. The data points on the L-IOB device folder provide data for the L-IOB device. The data points of the

I/O sub-folders expose the present value as well as status and configuration data specific to the I/O. Refer to Section 10.6 for more information on L-IOB data points.

The L-IOB data points can be used in the L-IOB host configuration just as all other data points. Depending on the “OPC”, “PLC In”, and “PLC Out” settings (see Section 11.2.2), the L-IOB data points are additionally exposed as OPC data points, logic program input data points, and logic program output data points.

## 11.2.5 Upgrade Firmware

The L-IOB firmware can be upgraded through the L-IOB host, if the host is a L-INX device. For doing so, the Configurator needs to be connected to the L-IOB host to perform the upgrade of all connected L-IOB modules.

### To Upgrade the L-IOB Firmware over the L-INX

1. Start the Configurator and connect to the L-INX device, which hosts the L-IOB I/O modules.
2. Select menu **Firmware / Update attached LIOB devices**.
3. This opens the Firmware Upgrade dialog as shown in Figure 74 and starts the detection of all connected L-IOB devices. Using the **Upgrade** checkbox in the **L-IOB Overview** list, it is possible to choose which devices shall be upgraded.
4. Click on the  buttons to select the L-IOB firmware images for LIOB-Connect/FT (LIOB-10x/15x) and LIOB-IP (LIOB-45x/55x) devices. Observe that there are different firmware images for these two groups. If only devices of one group are connected, the firmware image for the other group does not need to be selected.

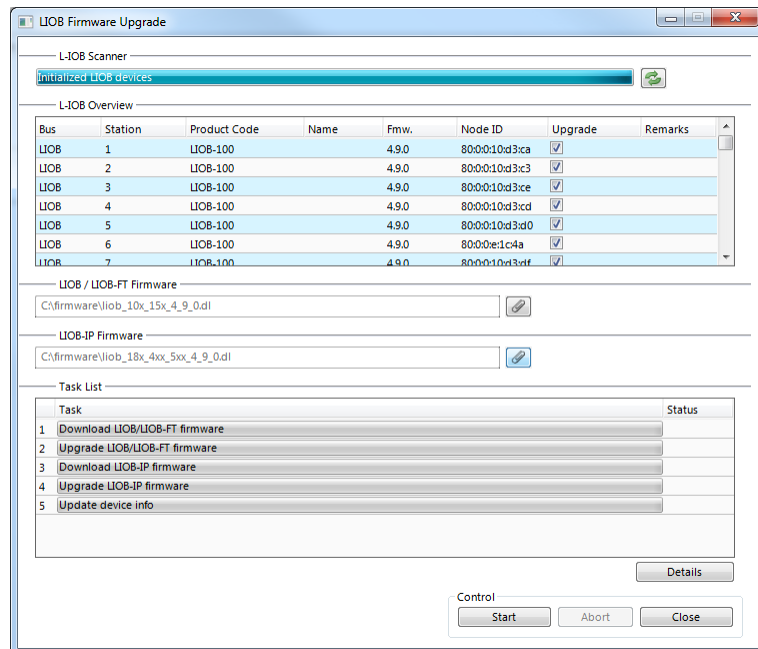



Figure 74: L-IOB Firmware Update dialog of the Configurator

5. Click on **Start**.
6. Observe the download progress. When the download is complete, click **Close**.

The L-IOB firmware of LIOB-45x/55x devices in LIOB-IP device mode can also be directly updated over IP. This method is faster and also the only possible upgrade method if the L-IOB host is a LIOB-48x/58x device.

### To Upgrade the LIOB-45x/55x Firmware directly

1. Start the Configurator and connect directly to the L-IOB device using a TCP/IP Connection.
2. Select menu **Firmware / Update**.
3. This opens a Firmware Update dialog similar to Figure 74. Click on the  button and select the L-IOB firmware image. Observe that LIOB-45x/55x devices need a different firmware than the other models.
4. Click on **Start**.
5. Observe the download progress. When the download is complete, click **Close**.

## 11.2.6 Printing Labels

For documentation purpose, I/O labels can be printed and glued to the top and bottom of the LIOB enclosure. It is recommended to use **Avery L6031REV** labels for printing.

### To Print the L-IOB labels

1. Start the Configurator and open the L-IOB host project, which contains the L-IOB devices to print labels for.
2. Select menu **File / Print**.
3. This opens the Print View dialog as shown in Figure 75. Select **Export LIOB Labels** on the left side.

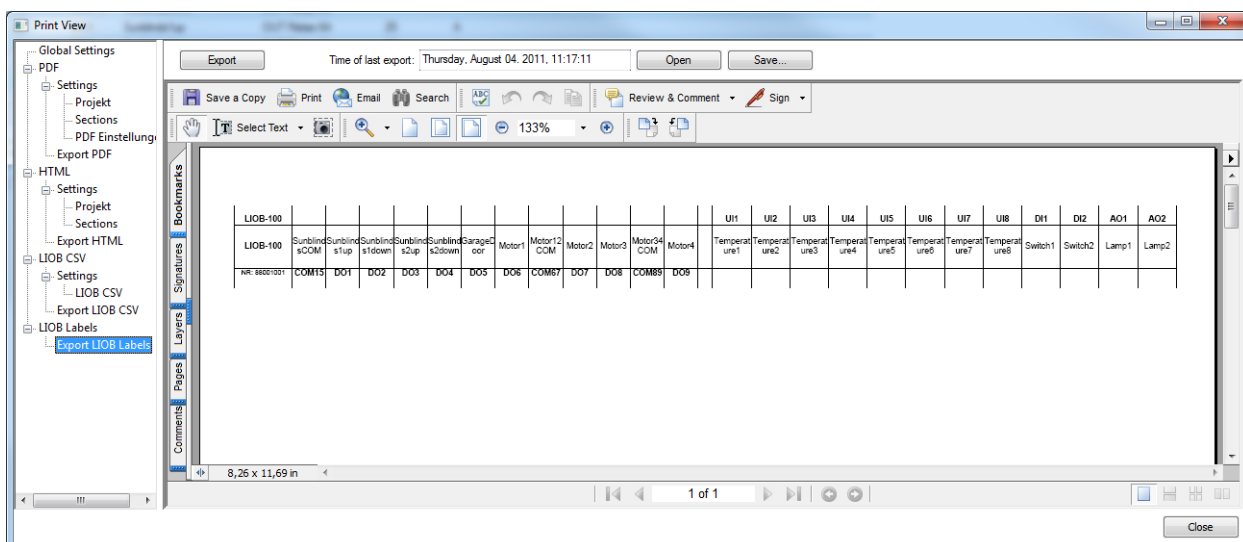

Figure 75: Print View

4. Click on **Export** to generate a PDF file of the labels.
5. Click on **Open** to open the file in a separate PDF reader window. Click on **Save** to save the PDF file.

- Print the labels directly from the PDF reader embedded in the print view or from the opened / saved PDF file.

## 11.3 Configuring L-IOB Modules (LONMARK® / Non-ECS device mode)

This section only applies to LIOB-15x/45x models in LONMARK® or Non-ECS device mode. Please refer to Section 5.1 for more information on L-IOB device modes.

### 11.3.1 Connecting to a L-IOB Module

#### 11.3.1.1 Connection via LNS™

When an LNS™ based network management tool is used, the L-IOB device must first be commissioned in the tool (e.g. NL-220™ or LonMaker™). Make sure to register the L-INX Configurator Software as a plug-in in the network management tool beforehand. The registration must be renewed, if an older version of the L-INX Configurator Software is already registered in the database. This will ensure that the required device templates for the different L-IOB models are installed and the Configurator Software is registered for these models. These templates are used to create and commission L-IOB devices (off- or online) in the database. Once the devices are created, the 'Configure' function of the network management tool can be used to invoke the Configurator Software. Alternatively, the LNS™ connection can also be done explicitly in the Configurator Software by choosing **Connection / Connect via LNS**. This will invoke the LNS connection dialog shown in Figure 76.

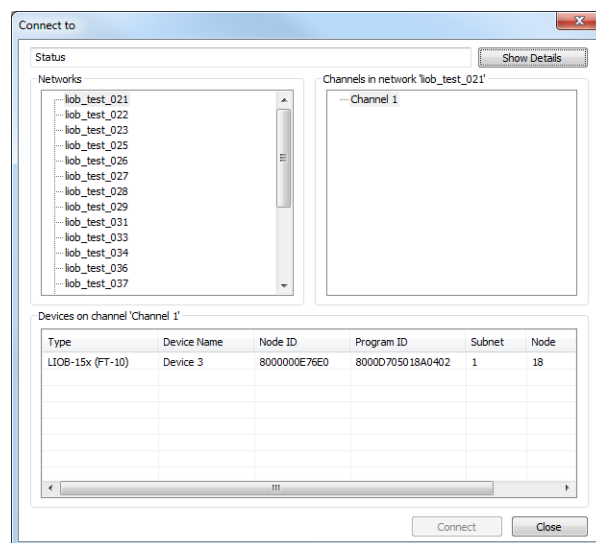

Figure 76: LNS Connection Dialog

Here the user can choose the network (database), channel, and L-IOB device to connect to.

#### 11.3.1.2 Connection via LOYTEC NIC

For non-LNS™ based network management tools, the L-IOB devices are configured independently from the network management tool by directly connecting via a LOYTEC NIC (Network Interface) such as a NIC-USB100 or NIC852. Observe that for LIOB-45x Models, a NIC852 must already be entered in the CEA-852 channel, the L-IOB device is a member of. Refer to the LOYTEC NIC Software documentation for more information.

The first step is choosing **Connection / Connect to device**, which invokes the device connection template dialog shown in Figure 77.

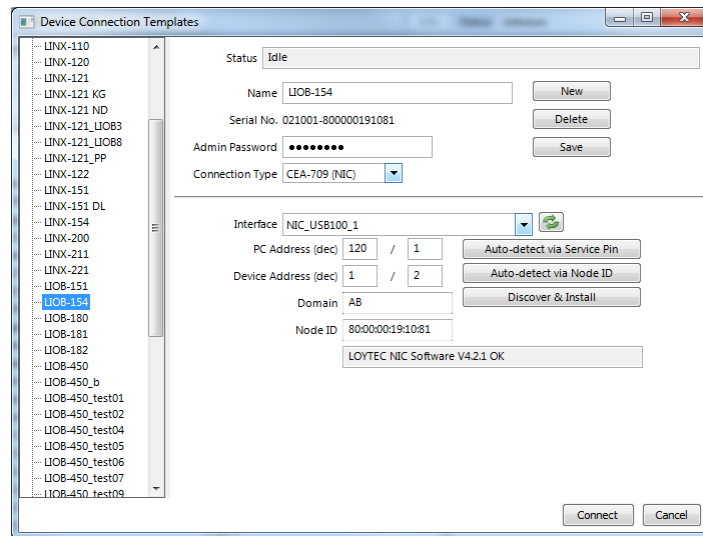

Figure 77: Device Connection Template Dialog

A new connection template can be created by clicking **New**. The **Admin Password** of a L-IOB device is 'loytec4u' by default. The connection type **CEA-709 (NIC)** must be chosen. The connection template can be saved under a certain **Name** before connecting. In the field **Interface**, the LOYTEC NIC, the L-IOB device is connected to, must be chosen. The **PC Address** (subnet / node) must be chosen so that it does not interfere with any existing CEA-709 address on the network. The **Domain** must match the domain of the L-IOB device. The **Device Address** (subnet / node) of the L-IOB device can be entered manually or detected via the **Auto-detect** buttons. Observe that the L-IOB device must already be set online before connecting to the Configurator Software. This can be achieved by using the L-IOB LCD Display, see Section 6.4. By clicking **Connect**, the connection to the L-IOB device is finally established.

Observe that if using a network management tool which does not support changeable network variables, the L-IOB device must be configured before commissioning it in the network management tool. In this case, the corresponding L-IOB device template of the network management tool must be created online from the device and not from the XIF file.

### 11.3.1.3 Connecting via IP (LIOB-45x)

For updating the firmware of LIOB-45x devices, it is also possible to directly connect to the L-IOB device via IP. Observe that this connection method can only be used for firmware upgrade and not e.g. for configuration download. To connect via IP:

1. Select the FTP connection method by clicking on the **Connect to device** button



in the tool bar of the main window. The connect dialog as shown in Figure 78 opens containing the managed device connection templates.



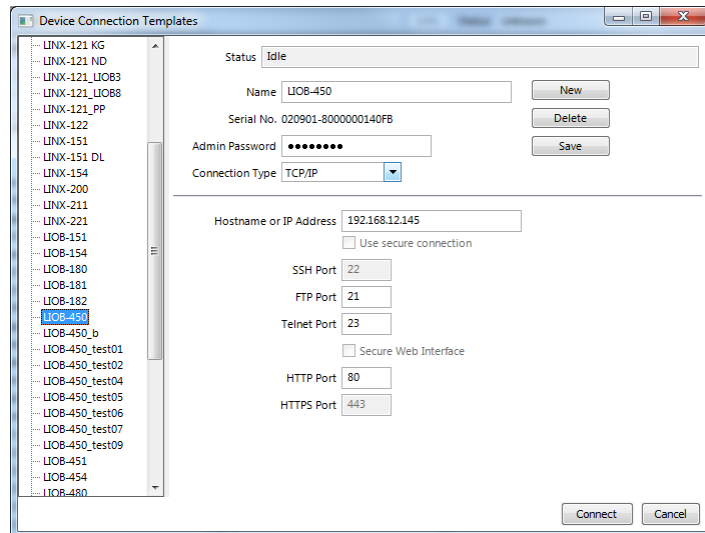

Figure 78: TCP/IP connection dialog.

2. To add a new device connection, click on **New** or select an existing connection in the tree on the left-hand side.
3. Enter a name for the connection.
4. Enter the admin password. The default password is 'loytec4u' (older firmware versions used 'admin').
5. Choose the **Connection Type TCP/IP**.
6. Enter the host name or IP address of the device.
7. If your device is located behind a NAT router or firewall, you may change the FTP, Telnet, SSH, and HTTP ports to your needs for accessing the device.
8. Click on **Save** to store that connection.
9. Click on **Connect**. This establishes the connection to the device.

### 11.3.2 L-IOB Device Settings

The LIOB-15x/45x model is chosen either automatically after connecting to the L-IOB device (see Section 11.3.1) or manually after starting the Configurator in the menu **Model**. The Configurator will show the **L-IOB Device** tab as depicted in Figure 79.

Nr.	Parameter name	Parameter value	Description
0	ProductCode	LIOB-150	Product code of L-IOB device
1	DeviceName	LIOB-OG3	Device name
2	PinCode		PIN code (empty or 0 to disable)
3	AlternativeUnit	<input type="checkbox"/>	SI/US unit setting
4	Language	English	Language setting for LCD display
5	GroupInMinSendTime	0	Minimum wait time between updates of digital group input NV (rate limitation)
6	GroupInMaxSendTime	0	Maximum time between updates of digital group input NV (heart beat)
7	GroupOutFBMinSendTime	0	Minimum wait time between updates of digital group output feedback NV (rate limitation)
8	GroupOutFBMaxSendTime	0	Maximum time between updates of digital group output feedback NV (heart beat)

Figure 79: LIOB Device Tab

In the **Device Parameters** table, the device specific configuration properties can be set. Refer to Section 10.2 for more information on device specific configuration properties.

### 11.3.3 Configure I/Os

Once a L-IOB device project is started, the I/Os have a default configuration. To adapt the I/Os to the specific needs in a project they can be freely configured. Whenever changes have been made, they can be explicitly validated by clicking on **Validate configuration**  in the **L-IOB I/Os** tab.

#### To Configure I/Os

7. Select the **L-IOB I/Os** tab.



8. The **L-IOB I/Os** tab displays the I/Os available on that L-IOB device in the **Inputs / Outputs** list.

Inputs / Outputs

Nr.	TerminalNr	Terminal	Name	Hardware type
1	1	UI1	UI1	IN Analog/Digital
2	2	GND12	GND UI1-UI2	IN Analog/Digital
3	3	UI2	UI2	IN Analog/Digital
4	4	UI3	UI3	IN Analog/Digital



9. To adapt the I/O name, double-click the name in the **Name** column and edit it, e.g., 'RoomTemp'.

Nr.	TerminalNr	Terminal	Name	Hardware type
1	1	UI1	RoomTemp	IN Analog/Digital

10. Select (or multi-select) an I/O in the **Inputs/Outputs** list and observe the **Object parameters** list below. These parameters can be used to configure the I/O.

Object parameters



Nr.	Parameter name	Parameter value	Unit	Range	Description
0	Name	RoomTemp			Terminal name
1	HardwareType	IN Analog/Digital			Terminal type
2	SignalType	Voltage 0-10V			Type of the input/output signal





11. For example, change the **SignalType** of the input UI1 to 'Resistance'.
12. Note that the object configuration properties may change when changing the signal type or interpretation. For detailed information on available configuration properties and their dependencies refer to Section 10.3. In this example you may now edit the **Interpretation** to 'NTC10K', which will allow connecting an NTC temperature sensor to the input.
13. I/Os of the same hardware type can be copied using the **Copy selected object**  and **Paste to selected object(s)**  buttons.

### 11.3.4 Manage L-IOB Configurations

L-IOB configurations can be managed by the user. One may duplicate the device for repeated use in the project. Also, a new template may be generated from the L-IOB configuration, which can be re-used in other projects.

#### To Manage L-IOB Configurations

1. To export a new template for a L-IOB configuration click the **Export device template** button  in the **L-IOB Device** tab. In the file save dialog, enter a new L-IOB template file name and store it. This file can then be used in a different project using the **Import Template** button .

- Existing configurations can be updated with new L-IOB templates by using the **Upgrade Template** button  in the **L-IOB Device** tab. This can be used e.g. to migrate new functions which were not yet available in earlier template versions. It is highly recommended to backup the original L-IOB project before upgrading templates. After upgrading the template, a log is displayed, which shows all information about the upgrade process. Please carefully review this log before using the updated configuration.
- Another way of managing L-IOB configurations is using terminal configurations. A terminal configuration can be created from an I/O object in the **Inputs / Outputs** list of the **L-IOB I/Os** tab by using the **Export object to disc** button  next to the list. In this case, only the configuration of this I/O is stored in an XML file. Terminal configurations can be imported (to one or multiple I/Os of the same hardware type) by using the **Import object from disc** button .
- These terminal configurations can also be used to configure all I/Os of the L-IOB device using a CSV file. Please see Section 11.2.3 for more information.
- To setup translation tables for certain I/O interpretation modes, click the **Edit translation tables** button  in the **L-IOB Device** tab, see Figure 72 as well as the end of Section 11.2.3.

### 11.3.5 Up- and Download of Configurations

Once the L-IOB configuration is finished, it can be downloaded into the connected L-IOB device using **Tools / Download Configuration**. In case of an LNS™ connection, this can also be done if the device is not (yet) physically connected to the network. In this case, only the LNS™ database is updated. The download dialog will offer an option to reset all counter values in the L-IOB device under **LIOB options / Reset counters**. All counter inputs as well as output run hours and energy counts will be reset in this case.

A configuration can also be uploaded from the connected L-IOB device using **Tools / Upload Configuration**. In case of an LNS™ connection, this can also be done if the device is not physically connected to the network or the network is offline. In this case, only the values from the LNS™ database are uploaded.

### 11.3.6 Using L-IOB Data Points

The data points of the LIOB-15x/45x device are represented as network variables (NVs) and configuration properties (CPs). The NVs can be polled or bound in a network management tool. The CPs can be accessed via LONMARK® file transfer. Refer to Section 10.7 for more information about L-IOB NVs and CPs.

### 11.3.7 Upgrade Firmware

The L-IOB firmware can be upgraded through the Configurator software. For doing so, the Configurator needs to be connected to the L-IOB device.

#### To Upgrade the L-IOB Firmware

- Start the Configurator and connect to the L-IOB device, see Section 11.3.1.
- Select menu **Firmware / Update**.
- This opens the Firmware Update dialog, which will look similar to Figure 74. Click on the  button and select the L-IOB firmware image. Observe that LIOB-45x/55x devices need a different firmware than the other models.
- Click on **Start**.

5. Observe the download progress. When the download is complete, click **Close**.

### 11.3.8 Backup and Restore

A backup of the complete state of a L-IOB device, including the I/O configuration, commissioning data, binding information, L-IOB LCD settings, etc. can be created by using **Tools / Backup Device Configuration**. The L-IOB device must be connected to the Configurator to perform this operation, see Section 11.3.1. The backup will be stored as a ZIP file. This file can later be used to restore the old device configuration again. It can also be used to physically replace a device and copy the configuration of the old device to the new one. A device configuration is restored by using **Tools / Restore Device Configuration**.

### 11.3.9 Printing Labels

For documentation purpose, I/O labels can be printed and glued to the top and bottom of the LIOB enclosure. It is recommended to use **Avery L6031REV** labels for printing.

#### To Print the L-IOB labels

1. Start the Configurator and open the L-IOB project to print labels for.
2. Select menu **File / Print**.
3. This opens the Print View dialog as shown in Figure 75. Select **Export LIOB Labels** on the left side.
4. Click on **Export** to generate a PDF file of the labels.
5. Click on **Open** to open the file in a separate PDF reader window. Click on **Save** to save the PDF file.
6. Print the PDF directly from the PDF reader embedded in the print view or from the opened / saved PDF file.

---

## 11.4 Configuring L-IOB Modules (BACnet Mode)

This section only applies to LIOB-55x models in BACnet device mode. Please refer to Section 5.1 for more information on L-IOB device modes. Observe that unlike the LIOB-45x models, the LIOB-55x models (in BACnet Mode) support advanced features such as technology-independent data points, alarming, scheduling, and trending (AST), etc. Please refer to the L-INX user manual [1] and LIOB-x8x user manual [2] for more information on these advanced features. In this section, only the essential features for operating as a BACnet I/O module are covered.

### 11.4.1 Connecting to a L-IOB Module

For connecting to a LIOB-55x device in BACnet device mode:

1. Select the FTP connection method by clicking on the **Connect to device** button



in the tool bar of the main window. The connect dialog as shown in Figure 78 opens containing the managed device connection templates.

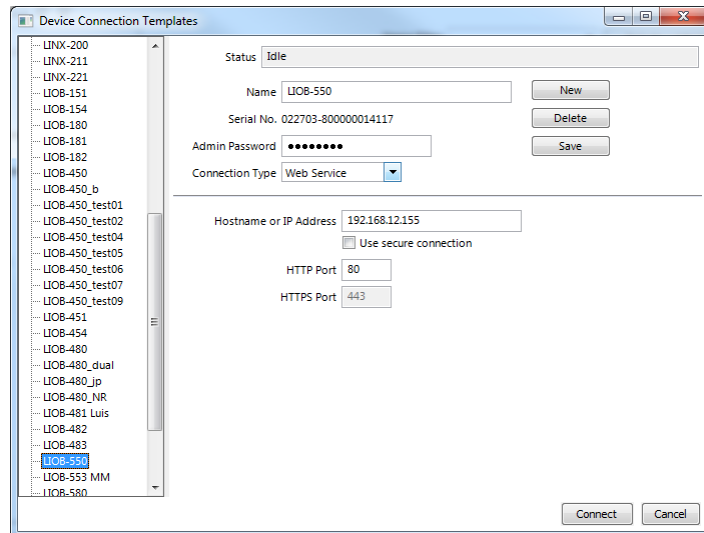



Figure 80: Device connection dialog.

2. To add a new device connection, click on **New** or select an existing connection in the tree on the left-hand side.
3. Enter a name for the connection.
4. Enter the admin password. The default password is 'loytec4u' (older firmware versions used 'admin').
5. Choose a **Connection Type**. Possible options are:
  - a. **Web service** (recommended): Firewall-friendly connection using HTTP.
  - b. **TCP/IP**: This uses the IP protocols FTP and Telnet to connect to the device.
6. Enter the host name or IP address of the device.
7. If your device is located behind a NAT router or firewall, you may change the FTP, Telnet, SSH, and HTTP ports to your needs for accessing the device.
8. Click on **Save** to store that connection.
9. Click on **Connect**. This establishes the connection to the device.

### 11.4.2 Configure I/Os

Once a L-IOB device project is started, the I/Os have a default configuration. To adapt the I/Os to the specific needs in a project they can be freely configured. Whenever changes have been made, they can be explicitly validated by clicking on **Validate configuration**  in the **L-IOB** tab.

#### To Configure I/Os

1. Select 'LIOB-LOCAL' at the left side of the **L-IOB** tab.

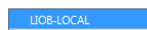

2. The **L-IOB** tab displays the I/Os available on that L-IOB device in the **Inputs / Outputs** list.

Inputs / Outputs

Nr.	TerminalNr	Terminal	Name	Hardware type
1	1	UI1	UI1	IN Analog/Digital
2	2	GND12	GND UI1-UI2	IN Analog/Digital
3	3	UI2	UI2	IN Analog/Digital
4	4	UI3	UI3	IN Analog/Digital



- To adapt the I/O name, double-click the name in the **Name** column and edit it, e.g., 'RoomTemp'.

Nr.	TerminalNr	Terminal	Name	Hardware type
1	1	UI1	RoomTemp	IN Analog/Digital

- Select (or multi-select) an I/O in the **Inputs/Outputs** list and observe the **Object parameters** list below. These parameters can be used to configure the I/O.

Object parameters



Nr.	DP Create	OPC	PLC In	PLC Out	Parameter name	Parameter value	Unit	Range	Description
0	<input type="checkbox"/>	<input type="checkbox"/>	<input type="checkbox"/>	<input type="checkbox"/>	Name	RoomTemp			Terminal name
1	<input type="checkbox"/>	<input type="checkbox"/>	<input type="checkbox"/>	<input type="checkbox"/>	HardwareType	IN Analog/Digital			Terminal type
2	<input type="checkbox"/>	<input type="checkbox"/>	<input type="checkbox"/>	<input type="checkbox"/>	SignalType	Voltage 0-10V			Type of the input/output signal



- For example, change the **SignalType** of the input UI1 to 'Resistance'.
- Note that the object configuration properties may change when changing the signal type or interpretation. For detailed information on available configuration properties and their dependencies refer to Section 10.3. In this example you may now edit the **Interpretation** to 'NTC10K', which will allow connecting an NTC temperature sensor to the input.
- For inputs with interpretation "Pulse Count", it is possible to choose between the **BACnet Object Type** "Analog Input" and "Accumulator". The native BACnet server object names and descriptions will initially receive unique I/O names as described in Section 10.8.2. They can be set to the current I/O names and descriptions by using the button **Set BACnet Names** .
- I/Os of the same hardware type can be copied using the **Copy selected object**  and **Paste to selected object(s)**  buttons.

### 11.4.3 Manage L-IOB Configurations

L-IOB configurations can be managed by the user. One may duplicate the device for repeated use in the project. Also, a new template may be generated from the L-IOB configuration, which can be re-used in other projects.

#### To Manage L-IOB Configurations

- To export a new template for a L-IOB configuration click the **Export device template** button  in the **L-IOB** tab. In the file save dialog, enter a new L-IOB template file name and store it. This file can then be used in a different project using the **Import Template** button .
- Existing configurations can be updated with new L-IOB templates by using the **Upgrade Template** button  in the **L-IOB** tab. This can be used e.g. to migrate new functions which were not yet available in earlier template versions. It is highly recommended to backup the original L-IOB project before upgrading templates. After upgrading the template, a log is displayed, which shows all information about the upgrade process. Please carefully review this log before using the updated configuration.
- Another way of managing L-IOB configurations is using terminal configurations. A terminal configuration can be created from an I/O object in the **Inputs / Outputs** list of

the **L-IOB** tab by using the **Export object to disc** button  next to the list. In this case, only the configuration of this I/O is stored in an XML file. Terminal configurations can be imported (to I/Os of the same hardware type) by using the **Import object from disc** button .

6. These terminal configurations can also be used to configure all I/Os of the L-IOB device using a CSV file. Please see Section 11.2.3 for more information.
4. To setup translation tables for certain I/O interpretation modes, click the **Edit translation tables** button  in the **L-IOB** tab, see Figure 72 as well as the end of Section 11.2.3.

#### 11.4.4 Up- and Download of Configurations

Once the L-IOB configuration is finished, it can be downloaded into the connected L-IOB device using **Tools / Download Configuration**. The download dialog will offer an option to reset all counter values in the L-IOB device under **LIOB options / Reset counters**. All counter inputs as well as output run hours and energy counts will be reset in this case.

A configuration can also be uploaded from the connected L-IOB device using **Tools / Upload Configuration**.

#### 11.4.5 Using L-IOB Data Points

The data points of the LIOB-55x device are represented as BACnet server objects, see Section 10.8. The corresponding data points can be found in the **LIOB-55X / BACnet Port / Datapoints / Local IO** folder on the **Datapoints** tab, see Figure 81.

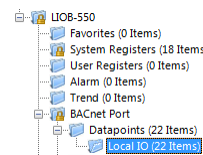

Figure 81: L-IOB BACnet data point folder

Usually, the BACnet server objects of network devices will be integrated using a central controller and BACnet operator workstation. In this case, the following two sections are not relevant.

However, if such a central controller is not available, the L-IOB BACnet server objects can also be directly connected to BACnet server objects on other devices using client mappings. This is done in the Configurator by dragging an imported BACnet object and dropping it on the local L-IOB BACnet server object. Therefore it is required to first import the corresponding BACnet server objects from other devices, which is achieved via BACnet network scan or EDE file import as described in the following two sections.

##### 11.4.5.1 Scan for BACnet Objects

LOYTEC devices support an online network scan on the BACnet network. In this scan the device searches for other devices on the BACnet network and pulls in the BACnet object information of these devices. These BACnet objects can then be used on the device as the basis for client mappings.

##### To Scan for BACnet Objects

1. Go to the **Datapoints** tab.
2. Select the folder **BACnet Network Scan**



- Right-click on that folder and select **Scan BACnet Network...**. This opens the BACnet Network Scan dialog as shown in Figure 82.

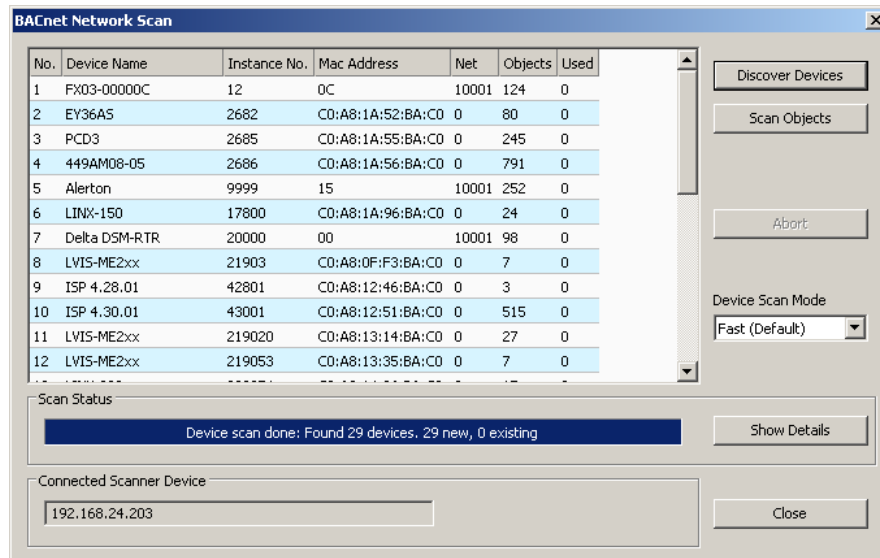

Figure 82: BACnet network scan dialog.

- Click on the button **Discover Devices**. This starts a network scan. The results are put in the device list box. A progress bar below indicates how many devices are being scanned.
- Select a device in the device list and click the button **Scan Objects**. This scans the BACnet objects on the selected device and adds them to the **BACnet Network Scan** folder as a separate sub-folder for the device.
- If the scan does not give the expected results, change the **Device Scan Mode** to normal or slow and try again. With this setting the scanner uses simpler but slower protocol features.
- Click **Close** when all devices needed have been scanned.

#### 11.4.5.2 Import from EDE File

If the device is engineered offline or some of the required BACnet devices are not yet online in the network, the engineering process can be done by importing a device and object list from a set of EDE files. These objects also appear in the import folder and can be later used on the device as client mappings.

There are a set of EDE files. Select the main EDE file, e.g. *device.csv*. The EDE import will also search for the other components, which must be named *device-states.csv*. Example EDE files can be found in the 'examples' directory of the LOYTEC Configurator software installation directory.

#### To Import BACnet Objects from an EDE File

- Go to the **Datapoints** tab.
- Select the folder **BACnet EDE File**





3. Right-click and select **Import File**. In the following file selector dialog, choose the EDE import file and click **OK**.
4. Now the **BACnet EDE File** folder is populated with the imported BACnet objects.

### 11.4.6 Upgrade Firmware

The L-IOB firmware can be upgraded through the Configurator software. For doing so, the Configurator needs to be connected to the L-IOB device.

#### To Upgrade the L-IOB Firmware

1. Start the Configurator and connect to the L-IOB device, see Section 11.4.1.
2. Select menu **Firmware / Update**.
3. This opens the Firmware Update dialog, which will look similar to Figure 74. Click on the  button and select the L-IOB firmware image. Observe that LIOB-45x/55x devices need a different firmware than the other models.
4. Click on **Start**.
5. Observe the download progress. When the download is complete, click **Close**.

### 11.4.7 Backup and Restore

A backup of the complete state of a L-IOB device can be created by using **Tools / Backup Device Configuration**. The L-IOB device must be connected to the Configurator to perform this operation, see Section 11.4.1. The backup will be stored as a ZIP file. This file can later be used to restore the old device configuration again. It can also be used to physically replace a device and copy the configuration of the old device to the new one. A device configuration is restored by using **Tools / Restore Device Configuration**.

### 11.4.8 Printing Labels

For documentation purpose, I/O labels can be printed and glued to the top and bottom of the L-IOB enclosure. It is recommended to use **Avery L6031REV** labels for printing.

#### To Print the L-IOB labels

1. Start the Configurator and open the L-IOB project to print labels for.
2. Select menu **File / Print**.
3. This opens the Print View dialog as shown in Figure 75. Select **Export LIOB Labels** on the left side.
4. Click on **Export** to generate a PDF file of the labels.
5. Click on **Open** to open the file in a separate PDF reader window. Click on **Save** to save the PDF file.
6. Print the PDF directly from the PDF reader embedded in the print view or from the opened / saved PDF file.

# 12 L-IOB Firmware Update

The L-IOB firmware supports remote upgrade over the L-IOB bus. To guarantee that the L-IOB is not destroyed due to a failed firmware update, the L-IOB firmware consists of two images:

1. fallback image,
2. primary image.

The fallback image cannot be changed. Thus, if the update of the primary image fails or the image is destroyed by some other means, the fallback image is booted and allows reinstalling a valid primary image.

When the L-IOB device boots up with the fallback image, the status LED is flashing red.

---

## 12.1 Firmware Update using the Configurator

Refer to Sections 11.2.5, 11.3.7, and 11.4.6 for information on how to upgrade the L-IOB firmware using the Configurator Software.

---

## 12.2 Firmware Update using LWEB-900

Refer to the user manual of LWEB-900 for information on how to upgrade the L-IOB firmware using this tool.

---

## 12.3 Firmware Update via the Web Interface (LIOB-45x/55x)

The device's firmware can also be upgraded using the Web interface. This option can be found in the **Config** menu under the **Firmware** item. For more details see Section 7.2.12.

# 13 L-IOB Device Replacement

A defective L-IOB device can easily be replaced with a new device of the same type without the need for any configuration changes.

---

## 13.1 L-IOB Device Replacement (L-INX Mode)

### 13.1.1 LIOB-Connect Device Replacement with L-INX Power-Cycle

This Section only applies to LIOB-10x devices. If a L-INX power cycle is acceptable, the L-IOB replacement on the LIOB-Connect bus can be performed without access to the L-INX Web UI or LCD UI using the following steps:

1. Switch off power of the L-INX device hosting the L-IOB device to be replaced.
2. Replace the L-IOB device with a new device of the same model.
3. Switch on power of the L-INX device again.
4. After a few minutes, all L-IOB devices including the replaced device will be online again.

In case not all L-IOB devices come online, check the status of the L-IOB devices in the L-INX Web UI (Chapter 9) or L-INX LCD UI (Chapter 8).

### 13.1.2 LIOB-Connect Device Replacement without L-INX Power-Cycle

This Section only applies to LIOB-10x devices. If a L-INX power cycle is not acceptable, the L-IOB replacement on the LIOB-Connect bus can be performed using the following steps:

1. Replace the L-IOB device with a new device of the same model. Observe that this means that all L-IOB devices after the replaced one will reboot.
2. Go to the **LIOB / Installation** page of the L-INX Web UI and click **Save Settings** or go to the **Device Settings / LIOB** page of the L-INX LCD UI (Chapter 8) and click **Configure LIOBs**.
3. The L-IOB devices will be configured as shown in the L-INX Web UI or LCD UI. At the end of the configuration run, all L-IOB devices including the replaced device will be online again.

In case not all L-IOB devices come online, check the status of the L-IOB devices in the L-INX Web UI or LCD UI.

### 13.1.3 LIOB-FT/IP Device Replacement

This Section only applies to LIOB-15x devices in LIOB-FT device mode and LIOB-45x/55x devices in LIOB-IP device mode. The L-IOB replacement on the LIOB-FT/IP bus can be performed using the following steps:

1. Replace the L-IOB device with a new device of the same model and set the device to LIOB-FT resp. LIOB-IP device mode (see Section 5.1).
2. For LIOB-45x/55x devices, at first the IP and host configuration must be done (see Section 5.2.2).
3. In the L-IOB LCD interface, setup the station ID of the new device as it was configured in the replaced device (see Section 5.2.2).
4. In the L-IOB LCD interface, request a device configuration from the L-IOB host (also see Section 6.4).
5. After a short time, all L-IOB devices including the replaced device will be online again.

In case not all L-IOB devices come online, check the status of the L-IOB devices in the L-IOB host Web UI (Chapter 9) or L-IOB host LCD UI (Chapter 8).

---

## 13.2 L-IOB Device Replacement (LONMARK® Mode)

LIOB-15x/45x devices in LONMARK® or Non-ECS device mode can simply be replaced using the 'replace' method of the used network management tool. Alternatively, a backup of the old device can be created and restored into the new device using the LOYTEC NIC connection, see Section 11.3.8.

---

## 13.3 L-IOB Device Replacement (BACnet Mode)

LIOB-55x devices in BACnet device mode can simply be replaced using the backup/restore function. This can either be done using the Web UI (see Section 7.2.2) or the Configurator Software (menu **Tools / Backup Device Configuration** and **Tools / Restore Device Configuration**).

# 14 Troubleshooting

---

## 14.1 Technical Support

LOYTEC offers free telephone and e-mail support for the L-IOB product series. If none of the above descriptions solves your specific problem please contact us at the following address:

*LOYTEC electronics GmbH  
Blumengasse 35  
A-1170 Vienna  
Austria / Europe*

*e-mail : support@loytec.com  
Web : http://www.loytec.com  
tel : +43 (1) 4020805-100  
fax : +43 (1) 4020805-99*

or

*LOYTEC Americas Inc.  
N27W23957 Paul Road  
Suite 103  
Pewaukee, WI 53072  
USA*

*e-mail: support@loytec-americas.com  
Web: http://www.loytec-americas.com  
tel: +1 (512) 402 5319  
fax: +1 (262) 408 5238*

# 15 Application Notes

## 15.1 External Power Supply (not using LPOW-2415A)

When using a non-LOYTEC power supply (see Figure 83), the following rules must be complied with:

- Consistent polarity must be maintained when connecting LOYTEC I/O controllers and modules to the transformer. That is, the ‘- ~’ terminal of each I/O controller and each I/O module must be connected to the same terminal on the secondary side of the transformer.
- The I/O controllers and modules are half-wave rectified. Connecting two half-wave rectified devices to the same transformer without maintaining polarity will cause short circuit.
- The GND terminals of the I/O controller or module are internally wired to the ‘- ~’ terminal. Therefore, if powering I/O controllers and modules with the same transformer, it is again essential to maintain polarity. Failure to do so will result in short circuit and/or damaged device.
- If the transformer output must be grounded, connect the ‘- ~’ terminal to earth ground.

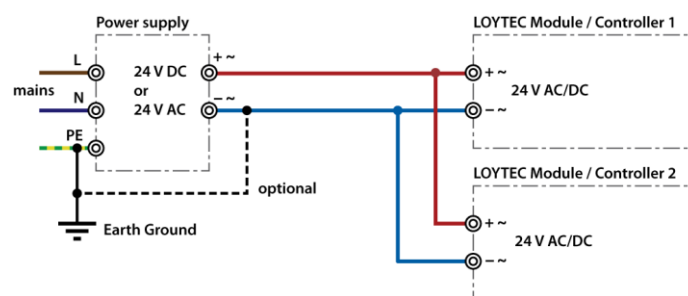

Figure 83: External power supply

## 15.2 Physical Connection of Inputs

### 15.2.1 Connection of Switches

On- or off-switches can either be connected to the DIs (Digital Inputs) or to the UIs (Universal Inputs) in digital interpretation.

### 15.2.1.1 Switch connected to a DI

A switch can be directly connected to a digital input as shown in Figure 84.

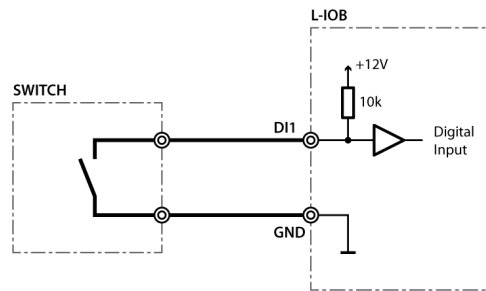

Figure 84: Switch connected to DI

The digital inputs (DI) recognize the following digital signals according to the connected resistance (switch):

Resistance of Switch	Status
< 6.8 k $\Omega$	Closed Switch
> 10 k $\Omega$	Open Switch

### 15.2.1.2 Switch connected to a UI

A switch can be directly connected to a universal input with signal type resistance as shown in Figure 85.

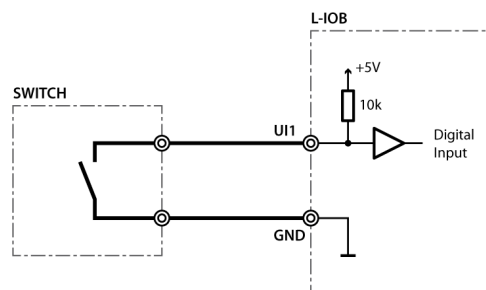

Figure 85: Switch connected to UI

UIs recognize the following digital signals according to the input resistance (switch):

Resistance Switch	Status
< 1.9 k $\Omega$	Closed Switch
> 6.7 k $\Omega$	Open Switch

## 15.2.2 Connection of S0 Pulse Devices (Meters)

S0 pulse meters must be connected to digital inputs (DI) as shown in Figure 86.

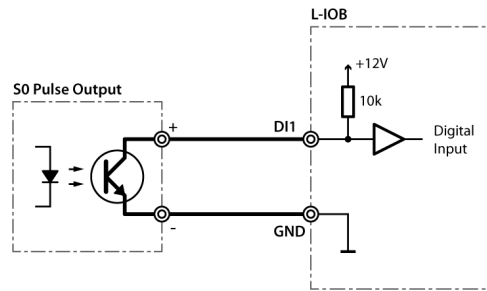

Figure 86: S0 pulse meter connected to DI

### 15.2.3 Connection of Voltage Sources to Universal Inputs

The Universal Input (UI) provides voltage measurement both if used as an analog or digital input. The signal type must be configured to 'Voltage 0-10V' or 'Voltage 2-10V' in both cases.

#### 15.2.3.1 Voltage Source connected to UI with Analog Interpretation

Figure 87 shows the connection of a voltage source to a universal input in analog mode.

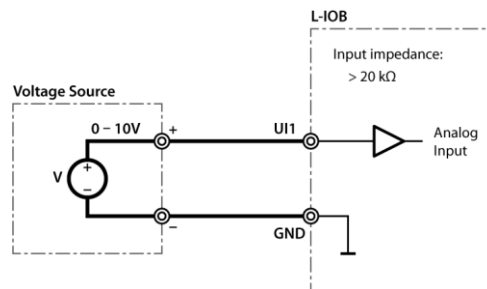

Figure 87: Voltage source on UI in analog mode

#### 15.2.3.2 Voltage Source connected to UI with Digital Interpretation

Figure 88 shows the connection of a voltage source to a universal input in digital mode. In this case, the voltage source acts as a switch with the depicted low and high levels.

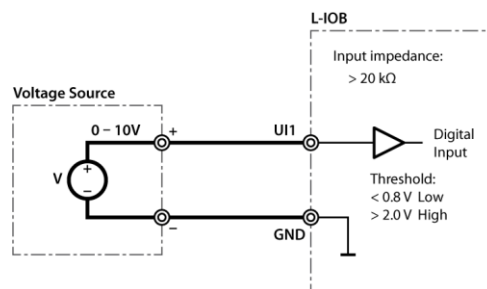

Figure 88: Voltage source on UI in digital mode

### 15.2.4 Connection of 4-20mA Transmitters to Universal Inputs

#### 15.2.4.1 4-20mA Transmitter connected to UI with Internal Shunt

Some universal inputs have an internal shunt which can be activated (in pairs with another UI) in the Configurator software (signal type 'Current 4-20mA int. Shunt'). Which UIs are equipped with shunts is documented in Section 17.4 and the following Sections. Figure 89 shows the connection of a 4-20mA transmitter to a universal input with internal shunt.



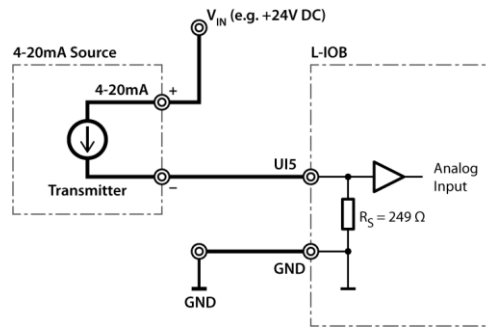

Figure 89: 4-20mA transmitter with internal shunt on UI

#### 15.2.4.2 4-20mA Transmitter connected to UI with External Shunt

On universal inputs, which do not have an internal shunt, an external shunt must be used as shown in Figure 90. The signal type must be set to ‘Current 4-20mA’ in the Configurator software.

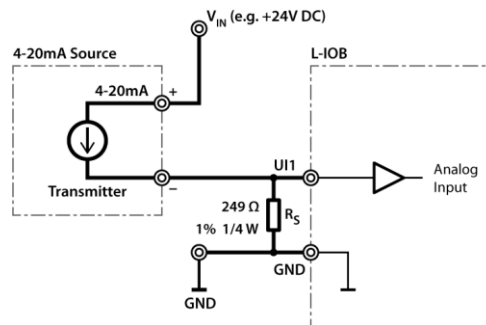

Figure 90: 4-20mA transmitter with external shunt on UI

#### 15.2.5 Connection of Resistive Sensors

Figure 91 shows the connection of resistive sensors to the universal inputs with a temperature sensor as an example. Sensors in the resistance range of 1 kΩ to 100 kΩ can be measured. The signal type must be set to ‘Resistance’ in the Configurator software.

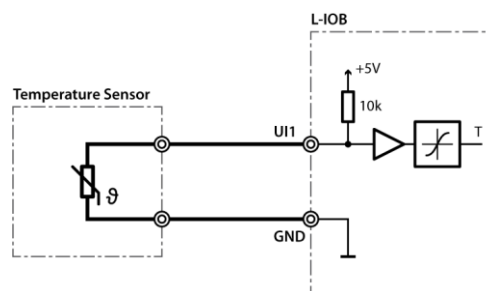

Figure 91: Temperature measurement on UI

#### 15.2.6 Connection of STId Card Readers

Figure 92 shows the connection of an STId card reader to three L-IOB inputs (UIs or DI). Observe that the clock signal must be connected to an interrupt-capable input of the L-IOB device. More information on STId card readers can be found in Section 10.5.

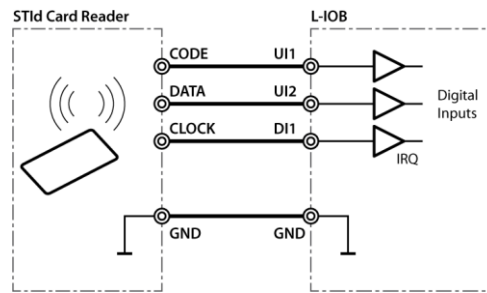

Figure 92: STId card reader

## 15.3 Physical Connection of Outputs

### 15.3.1 6A Relays on LIOB-100 (Built-in Fuse)

The LIOB-100 has a built-in fuse, rated with T 6.3A (time-lag), as shown in Figure 93.

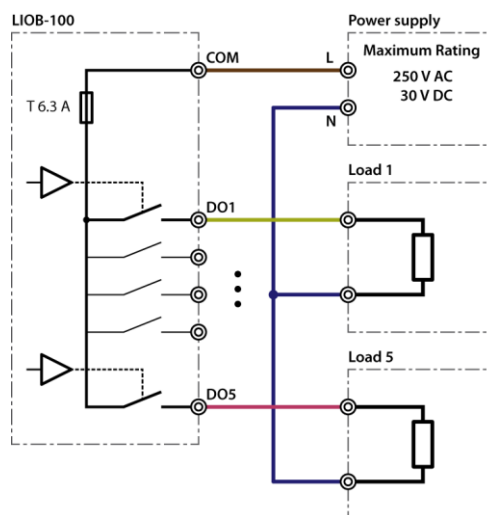

Figure 93: LIOB-100 6A relays

### 15.3.2 6A Relays with One External Fuse

The total current of all used 6A relays must be restricted to 6A, if more than two relays share a common (COM) terminal. The wiring shown in Figure 94 can be used for all L-IOB models with common terminals (and without a built-in fuse).

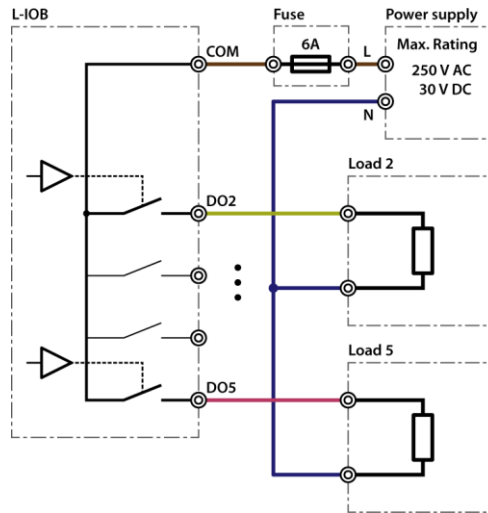

Figure 94: 6A relays with one external fuse

### 15.3.3 6A Relays on LIOB-xx2 using Separate Fuses

Figure 95 shows the wiring of the 6A relays for the LIOB-102/152/452/552 models using separate fuses. In this case, two relays share one common terminal (COM).

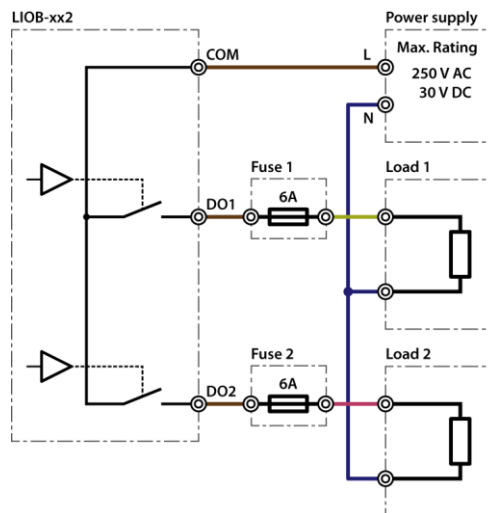

Figure 95: LIOB-102/152/452/552 6A relays

### 15.3.4 16A and 6A Relays on LIOB-xx3

The 16A and 6A relays on the LIOB-103/153/453/553 models all have two separate terminals per relay. There are no common (COM) terminals. This means that a 16A (or 6A) fuse must be wired to one of the two terminals of each relay, as shown in Figure 96.

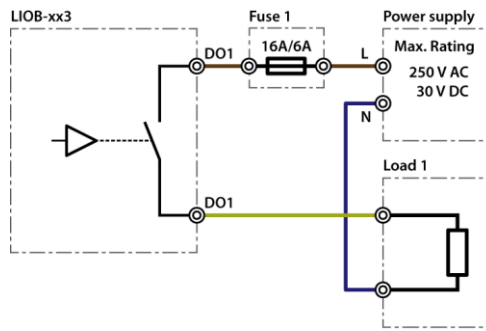

Figure 96: LIOB-103/153/453/553 16A/6A relays

### 15.3.5 External Relays and Inductive Loads

When controlling an external relay or inductive load using a L-IOB relay, either an integrated suppressor circuit must be used for the inductor, or a free-wheeling diode, a varistor, RC circuit, etc. must be installed to suppress voltage peaks and sparking due to switching off inductive circuits. It is recommended to use diodes that are part of the 1N400x family and to place them close to the relay, as shown in Figure 97. Figure 98 shows the connection of a 230V relay with a varistor.

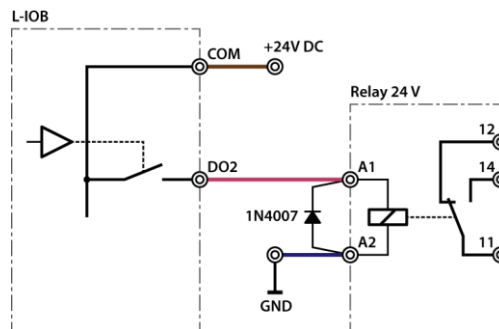

Figure 97: Suppressor circuit with free-wheeling diode

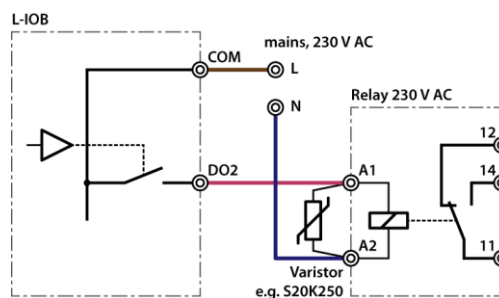

Figure 98: Suppressor circuit with varistor

### 15.3.6 1A Triacs

Figure 99 shows the wiring of the 1A Triac Outputs.

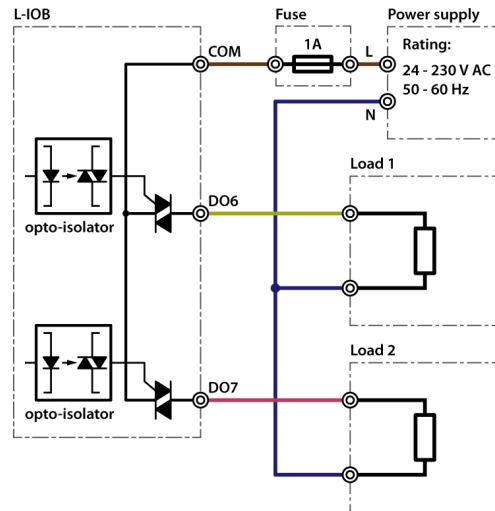

Figure 99: 1A Triacs

### 15.3.7 Analog Outputs

Figure 100 shows the wiring of the analog outputs (AO). Observe that the analog outputs are labeled '0-10V OUT' but are in fact capable of delivering over 11V.

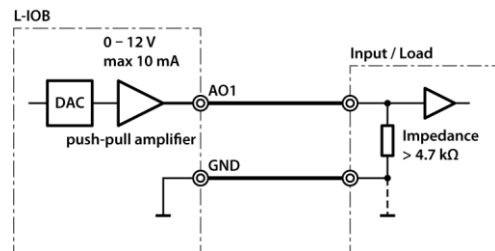

Figure 100: Analog outputs

The input impedance of the connected load must be greater than or equal to 4.7 kΩ for linear output.

## 15.4 Redundant Ethernet (LIOB-45x/55x)

### 15.4.1 Ethernet Cabling Options

Some L-IOB models are equipped with two Ethernet ports, which are connected to an internal Ethernet switch. This allows for advanced cabling options to reduce cabling costs or to increase network resilience. For this discussion, the term *upstream* is used to designate the direction towards the network, which the devices are connected to. Likewise, the term *downstream* is used to designate devices more distant to the network which the devices are connected to.

Redundant cabling options are enabled by the Rapid Spanning Tree Protocol (RSTP) which is implemented in most managed switches. Please note, that this is a feature of the switch, not of the L-IOB device, so that LOYTEC cannot give a guarantee that this will work with a particular switch model. In no case redundant cabling options will work with unmanaged switches. The older Spanning Tree Protocol (STP) should not be used for this type of application, as it converges too slowly.

**Star topology:** In the most basic setup, a device is connected to an Ethernet switch with one cable. This is called a star cabling because all devices are connected to a common upstream device. In this setup, the cable and the switch are single point of failures.

**Chain topology:** Because the L-IOB device itself acts as an Ethernet switch, this device can be connected to a chain. This is a special form of the star topology. Its advantage is the reduced cabling costs. The disadvantage is the connection loss to downstream devices when an upstream device is powered-off, reset or removed. Also, the Ethernet bandwidth (100 MBit/s) is shared among all members of the chain. The last device has one unused Ethernet port, as it is not allowed to create Ethernet loops without STP. The recommended maximum number of daisy-chained devices is 20.

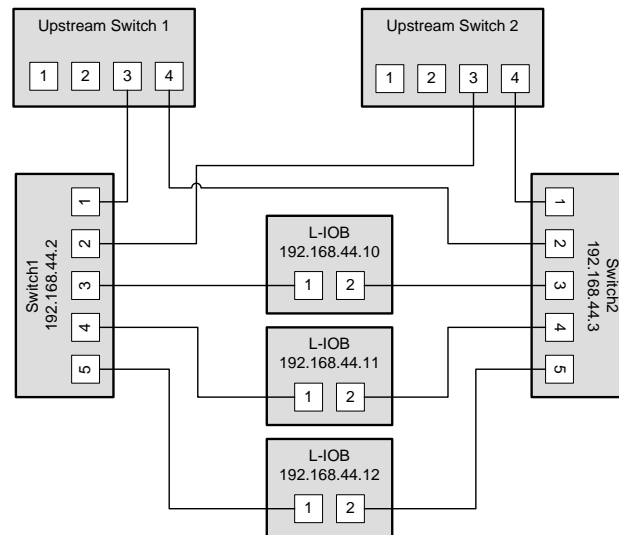

Figure 101: Fully redundant Ethernet topology

**Fully redundant topology:** Both Ethernet ports are connected to a different upstream switch. Thus, a single cable or upstream switch problem can be tolerated. This topology requires RSTP. In Figure 101, the L-IOB devices with IP addresses 192.168.44.10 to 192.168.44.12 are connected in this way. This connection scheme increases switch and cabling costs, but increases network resilience. Note that the upstream network is connected via the lowest-numbered ports. If this is not possible, the ports need to be configured to the lowest STP port priority value (which is the highest priority).

**Ring topology:** In this setup, the devices are connected in a chain and each end of the chain is connected to a different upstream switch. This topology requires RSTP. If a single device is powered off, the RSTP will automatically recalculate the spanning tree so that all other devices in the chain are reachable. Only if two devices are power-off at the same time, the devices between them will not have an Ethernet connection. In Figure 102, the L-IOB devices with IP addresses from 192.168.44.10 to 192.168.44.12 are connected in this way. The recommended maximum number of daisy-chained devices is 20.

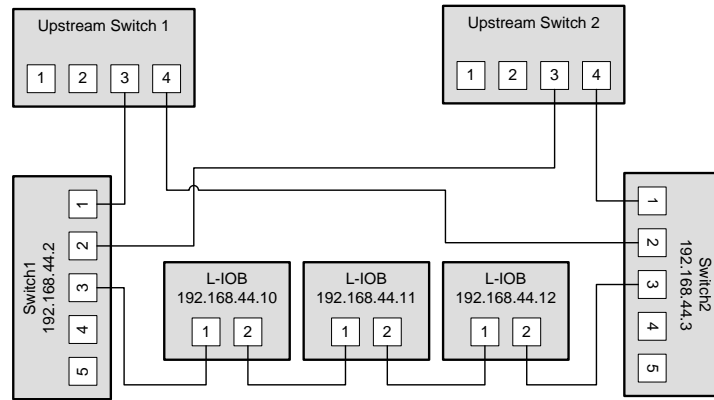

Figure 102: Ring Ethernet topology

## 15.4.2 Upstream Options

In case of redundant switches, there are two possible upstream topologies:

**Single upstream connection:** Switch1 (or Switch2, but not both) is connected to the upstream network while Switch2 only provides a redundant path to the LOYTEC devices. The redundant path is created by a direct Ethernet cable between Switch1 and Switch2 which needs to be plugged into a lower-numbered port than the L-IOB devices are connected to. If this is not possible, the STP port priority for the cross-connection cable needs to be set to a low value. The RSTP domain should be restricted to Switch1 and Switch2. This can be done by enabling a BPDU filter on the port on Upstream Switch 1. This will block all RSTP packets to enter the upstream network. A sample setup for this topology is shown in Figure 103.

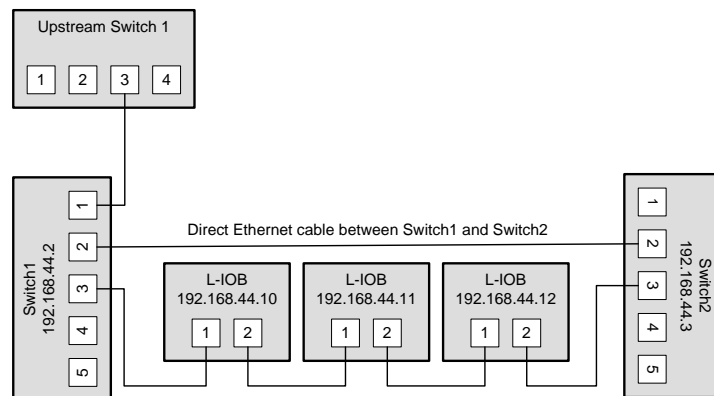

Figure 103: Single upstream connection.

**Redundant upstream connection:** Switch1 and Switch2 are both connected to the upstream network, either to two ports on the same switch or to two redundant upstream switches. In this case, RSTP is needed to ensure a loop-free topology between the upstream switches, Switch1 and Switch2, so the RSTP domain includes the upstream network and the chained L-IOB devices. The configuration of Switch1 and Switch2 need to ensure that they are not selected as the root bridge. If possible device communication should be bound to a separate VLAN and MSTP (Multiple Spanning Tree Protocol) should be employed to isolate the spanning tree operations. This topology is shown in Figure 101.

## 15.4.3 Preconditions

For the fully redundant and ring topology, the following preconditions have to be met:

- The upstream switches have to support the Rapid Spanning Tree Protocol (RSTP), as defined in IEEE 802.1w.
- The upstream switches have to provide a broadcast storm filter.
- Two distinct switches are required for each end of the device chain.
- Both upstream switches are connected to the same Ethernet network.

#### 15.4.4 Switch Settings

The switches which connect the devices to the network need the following settings. Note that these are only recommendations or starting points. Each network with redundant connections needs testing and verification to prevent network loops.

- The STP bridge must be enabled.
- The STP bridge priority should be set to the minimum (61440), so that these switches are not elected as root bridges.
- The bridge mode should match the upstream bridge modes, preferable 802.1s or 802.1w.

If the upstream network uses RSTP, the timing parameters of the upstream networks must be used. Else the timing parameters should be set to minimum values for fast convergence:

- Bridge max age time: 6 seconds
- Hello time: 1 seconds
- Forward delay: 4 seconds
- All ports connected to Ethernet rings have to be configured as NON-EDGE ports, so that the RSTP can detect loops
- The switches should be configured to block broadcast storms. A recommended rate is 5% or 3000 packets/seconds.

The upstream switches need the following configuration:

- If a single upstream connection is used, the connected port on the upstream switch should have BPDU filtering enabled.
- If redundant upstream connections are used, the connected ports on the upstream switches should have a BPDU root guard enabled.

#### 15.4.5 Testing

When the switches are configured and the devices are connected, the following tests are recommended. These tests are important to confirm that the STP changes due to topology changes do not interfere with the rest of the network.

- Check that no broadcast storms are sent into the upstream network by capturing traffic between Switch1, Switch2 and the Upstream switch. This test should be done continuously, especially during switch and device power cycles.
- Check that all devices can be reached (ICMP ping).

Execute these tests for these conditions:



- Power up all switches and devices. Wait until all devices are up, then test.
- Power-off Switch1. Wait approx. 10 seconds, then test.
- Power-on Switch2, power-off Switch1. Wait until Switch2 has booted, then test.
- Power-on Switch1. Wait until Switch1 has booted, then test.
- Reboot all L-IOB devices. Wait until the devices have booted, then test.
- Remove a single Ethernet cable. Wait approx. 10 seconds, then test. This test should be repeated for different cables. Make sure that at least the following connections are tested:
  - The connection between Switch1 and the L-IOB device directly connected to Switch1.
  - The connection between Switch2 and the L-IOB device directly connected to Switch2.
  - A connection in the middle of the chain, which is not connected directly to either Switch1 or Switch2.

#### 15.4.6 Example switch configuration

The following example shows the configuration commands for Switch1, Switch2 and the upstream switch (HP Procurve syntax) in the setup shown in Figure 101.

Upstream switches:

```
config
spanning-tree
spanning-tree priority 8
spanning-tree 3,4 root-guard
spanning-tree hello-time 1
spanning-tree forward-delay 4
spanning-tree maximum-age 6
exit
```

Switch1 and Switch2:

```
config
spanning-tree
spanning-tree priority 15
spanning-tree 1,2 port-priority 0
spanning-tree 3-5 port-priority 8
spanning-tree hello-time 1
spanning-tree forward-delay 4
spanning-tree maximum-age 6
exit
```

# 16 Security Hardening Guide

This guide contains security-relevant information for operating the LIOB-45x/55x models on IT networks. The information refers to the firmware version and the instructions found in the previous chapters of this User Manual.

---

## 16.1 Installation Instructions

Install the device over the Web interface:

- Set up the basic device functions and protocol settings as described in Chapter 7.
- Disable the FTP, and Telnet servers in the IP port configuration as described in Section 7.2.4.

---

## 16.2 Firmware

The device is equipped with one piece of software. This is the firmware image and its related firmware version. The firmware is distributed as a downloadable file. The device can be upgraded by placing the firmware image onto the device using the procedure described in Chapter 12.

---

## 16.3 Ports

This Section lists all ports, which may be used by the device. The ports are default settings for their respective services. If not stated otherwise, the ports can be changed.

Required Ports:

- 80 tcp: This port is opened by the Web server. The port can be changed.
- 1628 udp/tcp: This is the data exchange port for CEA-852 (LON over IP). It is required for the primary function of the device to exchange control network data between devices over the IP network. Each device needs this port open. The port can be changed in case of the LONMARK® mode (see Section 5.1).
- 47808 udp (LIOB-55x): This is the data exchange port for BACnet/IP. It is required for the primary function of the device to exchange control network data between routers over the IP network. Each device needs this port open. The port can be changed.

Optional ports not necessary for the primary product function. They can be disabled as described in the installation instructions in Section 16.1:

- 21 tcp: This port is opened by the FTP server. The port can be changed and disabled.

- 23 tcp: This port is opened by the Telnet server. The port can be changed and disabled.
- 5900 tcp: This port is opened by the VNC server, if it is enabled. This port is disabled by default. The port can be changed.

---

## 16.4 Services

Required services:

- CEA-852 (LON over IP): Primary function of the device. This service is in accordance with the standard ANSI/CEA-852-B.
- BACnet/IP (LIOB-55x): Primary function of the device. This service is in accordance with the standard ANSI/ASHRAE 135-2010.
- OPC XML-DA (LIOB-55x): This Web service provides access to data points over the OPC XML-DA standard.

Optional services not necessary for the primary product function. They can be disabled as described in the installation instructions in Section 16.1:

- HTTP: Web server. It provides a Web-based configuration UI. The Web UI can be disabled after setting up the device.
- FTP and Telnet: The FTP and Telnet server is used for connection to the device by the Configurator for configuration, firmware upgrade, and access to the log file. These services must be enabled during device configuration.
- VNC: The VNC server can be used for remote access to the LCD display on devices that have it. The service is disabled by default.

---

## 16.5 Logging and Auditing

The device contains a log file, which can be read out over FTP or the Web server. This log contains information when the device started and when crucial communication errors occur. Other information such user log-on are not logged as they are not part of the primary services of this device.

Logged events:

- Time of the last power-on reset of the device.
- Time and version of the last firmware upgrade.
- Time when the device was reset to factory defaults.
- Commission of the CEA-709 node.
- Static errors in the device and I/O configuration.
- System overload situations as one-time log messages since last power-on.
- Crucial communication errors as they occur.

# 17 Specifications

---

## 17.1 I/O Specification

### 17.1.1 UI - Universal Input

UIs are universal inputs for four different input types. They have an input voltage range of 0V to 10V, and can withstand up to 30V. The UIs correspond to class 1 with a relative accuracy of +/-1% (of measured value) between 1V and 10V, and an absolute accuracy of +/-10mV between 0V and 1V. The ADC resolution is 16 bits. Galvanically isolated sensors resp. switches must be connected. Universal inputs can be configured as:

- **Binary Input (Digital Input):** input impedance > 20kΩ, sampling period 10ms.
  - In voltage mode, the threshold values are < 0.8V for low level and > 2V for high level.
  - In resistance mode, the threshold values are < 1.9kΩ for low level and > 6.7kΩ for high level.

Between the threshold values, the resulting level of the UI is not defined.

- **Voltage Metering 0-10V:** input impedance > 20kΩ, sampling period < 1s.
- **Current Loop 4-20mA:** input impedance 249Ω, sampling period < 1s. An internal shunt of 249Ω is available for some universal inputs. Otherwise, an external resistor of 249Ω must be used as a shunt.
- **Resistance Measurement:** input impedance 10kΩ, sampling period < 1s. Resistors in the range of 1kΩ to 100kΩ can be measured.

The average sampling period  $p$  of analog inputs depends on the number of active (non-disabled) universal inputs  $n$  that are configured in analog mode. The formula for  $p$  is:

$$p = n * 125ms$$

This means if e.g. only two UIs are configured as analog inputs, a new sample is taken every 250ms (on average) for each of the two inputs. The UIs configured as digital inputs are unaffected (sampling period always 10ms) by this formula.

### 17.1.2 DI - Digital Input, Counter Input (S0-Pulse)

DIs are fast binary inputs, which can also be used as counter inputs (S0). They follow the S0 specification for electric meters and have a sampling period of 10ms. They change state at a

load of 195Ω between the DI terminal and GND. Galvanically isolated sensors resp. switches must be connected.

### 17.1.3 AO - Analog Output

AOs are analog outputs with a signal range of 0V to 10V (up to 12V), a resolution of 10 bits, and a maximum output current of 10mA (short circuit proof). The accuracy over the whole range is +/-100mV.

### 17.1.4 DO - Digital Output

The following digital outputs are available:

- Relay 6A Output: Switching capacity 6A, 250VAC resp. 30VDC.
- Relay 16A Output: Switching capacity 16A, 250VAC resp. 30VDC.
- TRIAC Output: Switching capacity 1A, 24 to 230VAC.

When connecting an air gap switch to a L-IOB relay, a quenching circuit like a varistor or RC element must be used.

### 17.1.5 PRESS - Pressure Sensor

These inputs represent differential pressure sensors which measure pressures from 0 - 500 Pascal. They are equipped with two 3/16" (4.8 mm) hose connectors.

## 17.2 Internal Translation Tables

The L-IOB devices offer fixed internal translation tables for easy configuration of some temperature sensors. The xin/xout values of these tables are listed in Table 11.

xout: Temp. [°C]	xin: Resistance [Ω]			
	PT1000	NTC10K	NTC1K8	Ni1000
-30	882.2	176680	24500	842
-20	921.6	96970	14000	893
-10	960.9	55300	8400	946
0	1000.0	32650	5200	1000
10	1039.0	19900	3330	1056
20	1077.9	12490	2200	1112
25	1097.4	10000	1800	1141
30	1116.7	8060	1480	1171
40	1155.4	5320	1040	1230
50	1194.0	3600	740	1291
60	1232.4	2490	540	1353
70	1270.0	1750	402	1417
80	1308.9	1260	306	1483
90	1347.0	920	240	1549
100	1385.0	680	187	1618
120	1460.6	390	118	1760

Table 11: Internal translation table values

---

## 17.3 Maximum Number of L-IOB Devices per L-IOB Host

Table 12 specifies the maximum number of L-IOB devices per L-IOB bus as well as the maximum total number of L-IOB devices per L-IOB host.

L-IOB Host	L-IOB Devices on LIOB-Connect Bus	L-IOB Devices on LIOB-FT Bus	L-IOB Devices on LIOB-IP Bus	L-IOB Devices Total
LINX-10x/11x/20x/21x	-	8	8	8
LINX-12x/22x/15x	24	24	24	24
LIOB-48x/58x	-	-	1	1

Table 12: L-IOB devices per L-IOB Host

After the first four L-IOB devices, which can be directly connected to the L-IOB host, each additional (local) group of up to four L-IOB devices requires a separate power supply (e.g. LPOW-2415A). In case of LIOB-Connect, each group additionally requires two LIOB-A2 adapters and an extension cable between the two adapters.

## 17.4 Specification for LIOB-10x Models

Dimensions [mm]	107 x 100 x 75 (L x W x H)			
Operating Temperature (ambient)	0°C to +50°C			
Storage Temperature	-10°C to +85°C			
Humidity (non condensing) operating / storage	10 to 90 % RH @ 50°C			
Environmental Protection	IP 40 (enclosure); IP 20 (screw terminals)			
Power Supply	24 VDC $\pm$ 10 %, powered over LIOB-Connect			
Installation	DIN rail mounting (EN 50 022), attachable or connected with a 4-wire cable, max. 50 m			
Interface	1 x LIOB-Connect			
Types	LIOB-100	LIOB-101	LIOB-102	LIOB-103
Power Consumption [W]	1.7 / 2.6 (all Relays on)	1.7	1.7 / 2.7	1.7 / 2.5
Universal Input (UI)	8	8	6	6
Digital Input (DI)	2	16	-	-
Analog Output (AO)	2	-	6	6
Digital Output (DO)	9 (5 x Relay, 4 x Triac)	-	8 (8 x Relay)	5 (5 x Relay)
Digital output specification	Relay: 6 A Triac: 1 A @ 24-230 VAC	-	Relay: 6 A	Relay: 16 A
Internal shunt available for current measurement	UI5 & UI6, UI7 & UI8	UI5 & UI6, UI7 & UI8	UI3 & UI4, UI5 & UI6	UI3 & UI4, UI5 & UI6
Supported STId card readers	3	2	-	-

## 17.5 Specification for LIOB-15x Models

Dimensions [mm]	107 x 100 x 75 (L x W x H)				
Operating Temperature (ambient)	0°C to +50°C				
Storage Temperature	-10°C to +85°C				
Humidity (non condensing) operating / storage	10 to 90 % RH @ 50°C				
Environmental Protection	IP 40 (enclosure); IP 20 (screw terminals)				
Power Supply	24 VDC / 24 VAC ±10 %				
Installation	DIN rail mounting (EN 50 022)				
Interface	1 x CEA-709/FT or LIOB-FT (configurable)				
Types	LIOB-150	LIOB-151	LIOB-152	LIOB-153	LIOB-154
Power Consumption [W]	1.7 / 2.6 (all Relays on)	1.7	1.7 / 2.7	1.7 / 2.5	1.7 / 2.5
Universal Input (UI)	8	8	6	6	7 + 1 x Pressure Sensor
Digital Input (DI)	2	12	-	-	-
Analog Output (AO)	2	-	6	6	4
Digital Output (DO)	8 (4 x Relay, 4 x Triac)	-	8 (8 x Relay)	5 (4 x Relay 16 A, 1 x Relay 6 A)	7 (5 x Relay, 2 x Triac)
Digital output specification	Relay: 6 A Triac: 1 A @ 24-230 VAC	-	Relay: 6 A	Relay: 16 A and 6 A	Relay: 6 A Triac: 1 A @ 24-230 VAC
Internal shunt available for current measurement	UI5 & UI6, UI7 & UI8	UI5 & UI6, UI7 & UI8	UI3 & UI4, UI5 & UI6	UI3 & UI4, UI5 & UI6	UI5 & UI6, UI7
Supported STId card readers	3	2	-	-	1



## 17.6 Specification for LIOB-45x Models

Dimensions [mm]	107 x 100 x 75 (L x W x H)				
Operating Temperature (ambient)	0°C to +50°C				
Storage Temperature	-10°C to +85°C				
Humidity (non condensing) operating / storage	10 to 90 % RH @ 50°C				
Environmental Protection	IP 40 (enclosure); IP 20 (screw terminals)				
Power Supply	24 VDC / 24 VAC ±10 %				
Installation	DIN rail mounting (EN 50 022)				
Interface	1 x IP-852 or LIOB-IP (configurable)				
Types	LIOB-450	LIOB-451	LIOB-452	LIOB-453	LIOB-454
Power Consumption [W]	1.7 / 2.6 (all Relays on)	1.7	1.7 / 2.7	1.7 / 2.5	1.7 / 2.7
Universal Input (UI)	8	8	6	6	7
Digital Input (DI)	2	12	-	-	-
Analog Output (AO)	2	-	6	6	4
Digital Output (DO)	8 (4 x Relay, 4 x Triac)	-	8 (8 x Relay)	5 (4 x Relay 16 A, 1 x Relay 6 A)	7 (5 x Relay, 2 x Triac)
Digital output specification	Relay: 6 A Triac: 1 A @ 24-230 VAC	-	Relay: 6 A	Relay: 16 A and 6 A	Relay: 6 A Triac: 1 A @ 24-230 VAC
Internal shunt available for current measurement	UI5 & UI6, UI7 & UI8	UI5 & UI6, UI7 & UI8	UI3 & UI4, UI5 & UI6	UI3 & UI4, UI5 & UI6	UI5 & UI6, UI7
Supported STId card readers	3	2	-	-	1

## 17.7 Specification for LIOB-55x Models

Dimensions [mm]	107 x 100 x 75 (L x W x H)				
Operating Temperature (ambient)	0°C to +50°C				
Storage Temperature	-10°C to +85°C				
Humidity (non condensing) operating / storage	10 to 90 % RH @ 50°C				
Environmental Protection	IP 40 (enclosure); IP 20 (screw terminals)				
Power Supply	24 VDC / 24 VAC ±10 %				
Installation	DIN rail mounting (EN 50 022)				
Interface	1 x BACnet/IP or LIOB-IP (configurable)				
Types	LIOB-550	LIOB-551	LIOB-552	LIOB-553	LIOB-554
Power Consumption [W]	1.7 / 2.6 (all Relays on)	1.7	1.7 / 2.7	1.7 / 2.5	1.7 / 2.7
Universal Input (UI)	8	8	6	6	7
Digital Input (DI)	2	12	-	-	-
Analog Output (AO)	2	-	6	6	4
Digital Output (DO)	8 (4 x Relay, 4 x Triac)	-	8 (8 x Relay)	5 (4 x Relay 16 A, 1 x Relay 6 A)	7 (5 x Relay, 2 x Triac)
Digital output specification	Relay: 6 A Triac: 1 A @ 24-230 VAC	-	Relay: 6 A	Relay: 16 A and 6 A	Relay: 6 A Triac: 1 A @ 24-230 VAC
Internal shunt available for current measurement	UI5 & UI6, UI7 & UI8	UI5 & UI6, UI7 & UI8	UI3 & UI4, UI5 & UI6	UI3 & UI4, UI5 & UI6	UI5 & UI6, UI7
Supported STId card readers	3	2	-	-	1

# 18 References

- [1] L-INX User Manual, LOYTEC electronics GmbH,  
Document № 88073018, March 2014.
- [2] LIOB-x8x User Manual, LOYTEC electronics GmbH,  
Document № 88080306, April 2014.

# 19 Revision History

Date	Version	Author	Description
2010-10-25	1.0	AB	Initial Version.
2010-11-11	1.1	AB	Added LIOB-150 Model.
2011-03-08	1.2	AB	Added LIOB-151, -152, and -153 Models, Changed “Normal” mode to “Auto” mode, Section 6.2: Added common terminals and terminal numbers, Section 6.3: New user interface for quick edit and manual mode, Section 6.4: Added host information, Section 6.5: Added raw value, Section 10.3.4: for analog and PWM outputs, 0% is always off, Sections 10.3.14 & 10.6.3: Added PulseTime, Chapter 11: Added new Configurator functions.
2011-07-29	2.0	AB	Added LIOB-15x LONMARK® and Non-ECS device modes, Added LCD language setup, New Section 8.2 L-IOB Remote Access, Section 6.4: Added L-IOB reset option, manual logout, and commissioning, Section 10.3.12: Added L-IOB host disconnect behavior, New Section 10.4: Switch Mode (LONMARK® Mode), New Section 10.9: Default Configuration, New Section 11.2.6: Printing Labels.
2012-01-12	2.0.1	AB	Minor Corrections.
2012-02-03	2.1	AB	Added Section 5.2.2: Device Installation (LIOB-FT/IP device mode), Added Interpretations Clock, Card Data, Fading, and Ramping in Section 10.3.4, Added Section 10.3.7: DeadTime for Fading and Ramping, Added Section 10.3.10: IOFunc, GroupNumber, and SubGroupNumber for Card Reader Mode, Added Section 10.5: STId Card Reader Mode.
2012-07-09	2.2	AB	Added LIOB-154 model and LIOB-45x models, Corrected LED patterns in Section 4.5.8, Added counting input options in Section 6.5, Corrected I/O specifications in Section 17.1, Added Export Terminal Config function in Section 11.2.3, Added Chapter 16: Security Hardening Guide.
2012-12-14	4.8	AB	Updated contact information in Section 14.1, Added Section 17.2: Internal Translation Tables,

Date	Version	Author	Description
			<p>Added LIOB-55x (BACnet/IP) models,            Added LIOB-48x/58x devices as L-IOB hosts on LIOB-IP bus,            Added Section 9.6: L-IOB I/O Test Page,            Added Section 17.3: Maximum Number of L-IOB Devices per L-IOB Host,            Some updates and corrections of specifications in Chapter 17,            Added applications notes for connecting I/Os in Chapter 15.</p>
2013-08-01	4.9	AB	<p>PWM period starts immediately when manual value changes, Section 10.3.4,            Physical unit display for pulse count interpretation in Section 10.3.4,            Added AnaInvert and Sqrt flags in Sections 10.3.14 and 10.3.15,            Added switch data type for interlocked mode in Section 10.3.8,            Only the most basic data points are created by default, Section 10.6,            Added DP Create, OPC, and PLC flags in Sections 11.2.1 and 11.2.2,            MaxSendTime now also works from L-IOB host to device, Section 10.3.24,            Improved description of MaxSendTime function in Section 10.3.24,            Easy identification of I/Os in network management tool, Section 10.7.4,            Some translations tables are now included in the Configurator, Section 11.2.3,            Manual mode in Web UI works even without L-IOB device, Section 10.3.11,            Faster sampling for analog inputs in Section 17.1.1,            Added spike suppression in Section 10.3.28,            Added fast device configuration in Section 6.4,            Basic IP configuration persistent over device mode change, Section 6.4,            Added L-IOB page in L-IOB device Web UI, Section 7.4,            Some general improvements regarding basic data points,            Updated all screenshots,            Two new columns in CSV import/export function, Section 11.2.3,            Added BACnet Accumulator object in Sections 10.8.2 and 11.4.2,            Added L-IOB unit settings in Section 11.1,            New firmware upgrade dialog in Section 11.2.5,            Added parameter merge dialog in Section 10.6.5.</p>
2014-04-04	5.0	AB	<p>Updated terminal layouts in Section 4.4,            Added Section 4.4.14: LIOB-454/554,            Added I/O specification for LIOB-454 in Section 17.6,            Added I/O specification for LIOB-554 in Section 17.7,            More precise specification of UI accuracy in Section 17.1.1,            Added device error codes in Section 10.6.2,            Added “Duration” mode for digital outputs in Section 10.3.5,            Added behavior of feedback value in Section 10.3.8,            Added behavior of invert flag for occupancy inputs in Section 10.3.13,            Added state-controlled occupancy sensors in Section 10.3.28,            Added description of all main page items in Section 6.1,            Added simplified calibration in Section 10.3.22,            New Section 10.3.16: NoValCorr Flag,            Added OPC, PLCIn, and PLCOut columns in Section 11.2.3,            Added Section 7.2.5: Ethernet Switch,            Added Section 7.2.12: Firmware (Upgrade over Web UI),            Updated Parameter Merge in Section 10.6.5,</p>

Date	Version	Author	Description
			Updated device connection dialogs in Sections 11.3.1 and 11.4.1, Added Section 12.3: Firmware Update via the Web Interface (LIOB-45x/55x), Added Section 15.4: Redundant Ethernet (LIOB-45x/55x), Added BTL certificate in Section 1.1, New Chapter 2: What's New.