

LDALI-BM2 L-DALI Pushbutton Coupler

Installation instructions

Instructions de montage

Montageanweisung

Montagevoorschrift

Istruzioni di montaggio

Instrucciones de montaje

Monteringsanvisning

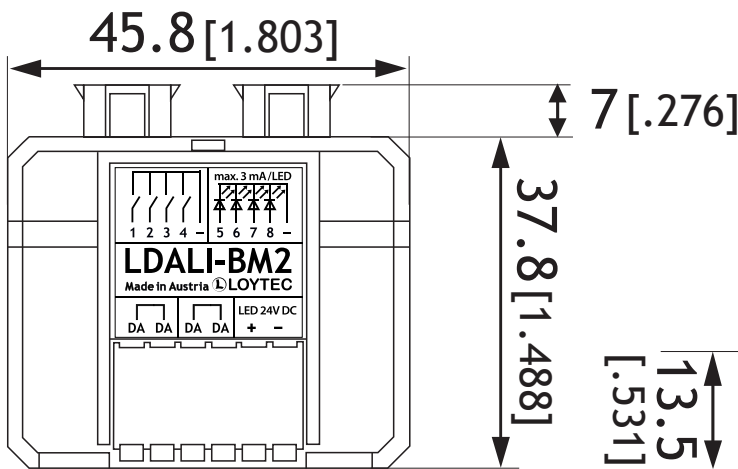
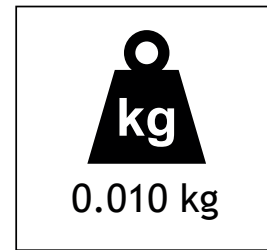
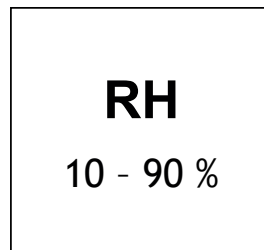
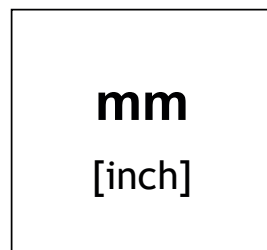
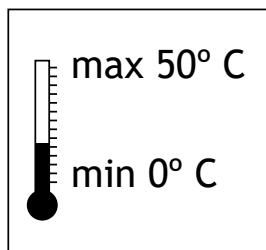

DALI Load:
typ. 3.0 mA
@ 16 V DC,
max. 6mA
inrush current

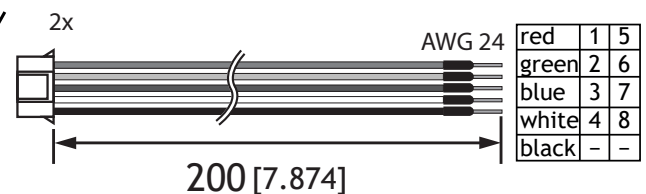
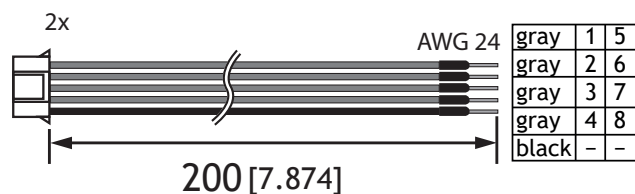
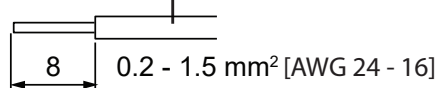
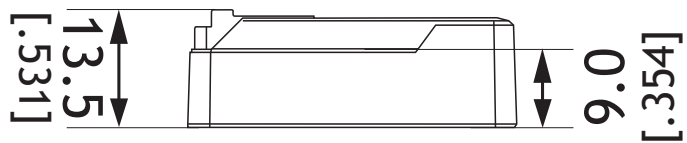

Wiring Diagram

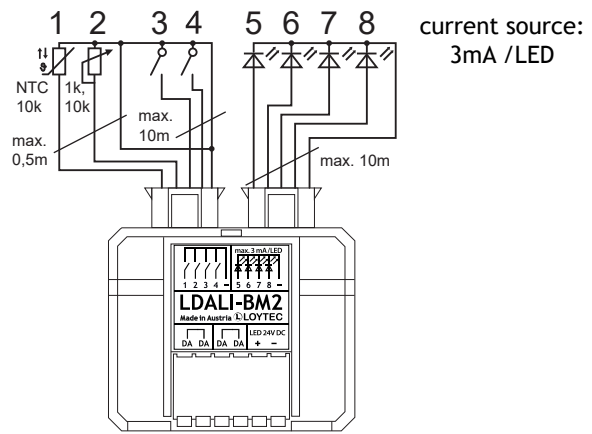
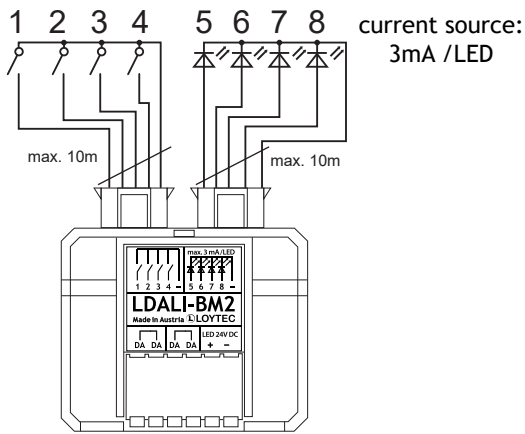

Terminal	Function
DA, DA	DALI-Bus
LED 24VDC+-	LED power supply, must be Earth free!
1, 2	Universal Input
3, 4	Digital Input
-	Input common
5, 6, 7, 8	LED output
-	LED common

⚠ Do NOT connect mains voltage (85-240 VAC) to the terminals 1, 2, 3, 4, 5, 6, 7, 8, +, -

i **Supply of feedback LEDs:**

Option 1: separate 24V DC power supply for each DALI-line, establish single point connection between GND and the DALI-line.

Option 2: connect DALI-line (take care of the DALI-polarity and be aware of the additional current consumption of 3mA/LED)

