L-INX/L-GATE

L-INX™ Automation Server

L-GATE™ Universal Gateway

User Manual

LOYTEC electronics GmbH



Contact

LOYTEC electronics GmbH
Blumengasse 35
1170 Vienna
AUSTRIA/EUROPE
support@loytec.com
<http://www.loytec.com>

Version 7.2

Document № 88073027

LOYTEC MAKES AND YOU RECEIVE NO WARRANTIES OR CONDITIONS,
EXPRESS, IMPLIED, STATUTORY OR IN ANY COMMUNICATION WITH YOU,
AND

LOYTEC SPECIFICALLY DISCLAIMS ANY IMPLIED WARRANTY OF
MERCHANTABILITY OR FITNESS FOR A PARTICULAR PURPOSE. THIS
PRODUCT IS NOT DESIGNED OR INTENDED FOR USE IN EQUIPMENT
INTENDED FOR SURGICAL IMPLANT INTO THE BODY OR OTHER
APPLICATIONS INTENDED TO SUPPORT OR SUSTAIN LIFE, FOR USE IN FLIGHT
CONTROL OR ENGINE CONTROL EQUIPMENT WITHIN AN AIRCRAFT, OR FOR
ANY OTHER APPLICATION IN WHICH IN THE FAILURE OF SUCH PRODUCT
COULD CREATE A SITUATION IN WHICH PERSONAL INJURY OR DEATH MAY
OCCUR. LOYTEC MAKES NO REPRESENTATION AND OFFERS NO WARRANTY
OF ANY KIND REGARDING OF ANY THIRDPARTY COMPONENTS MENTIONED
IN THIS MANUAL.

No part of this publication may be reproduced, stored in a retrieval system, or transmitted,
in any form or by any means, electronic, mechanical, photocopying, recording, or
otherwise, without the prior written permission of LOYTEC.

LC3020™, L-Chip™, L-Core™, L-DALI™, L-GATE™, L-INX™, L-IOB™,
LIOB-Connect™, LIOB-FT™, L-IP™, LPA™, L-Proxy™, L-Switch™, L-Term™,
L-VIS™, L-WEB™, L-ZIBI™, ORION™ stack and Smart Auto-Connect™ are
trademarks of LOYTEC electronics GmbH.

LonTalk®, LONWORKS®, Neuron®, LONMARK®, LonMaker®, *i.LON*®, and LNS® are
trademarks of Echelon Corporation registered in the United States and other countries.

Contents

1	Introduction	9
1.1	Overview	9
1.2	CEA-709.1	11
1.3	BACnet	12
1.4	M-Bus	13
1.5	Modbus	13
1.6	KNX	13
1.7	EnOcean	14
1.8	SMI	14
1.9	MP-Bus	14
1.10	L-IOB	15
1.11	Scripting	15
1.12	L-INX and L-GATE Models	15
1.13	Scope	18
2	Disclaimer Cyber Security	19
3	Safety Instructions	20
4	What's New in L-INX/L-GATE	24
4.1	New in L-INX/L-GATE 7.2.0	24
4.2	New in L-INX/L-GATE 7.0.0	28
4.3	New in L-INX/L-GATE 6.4.0	30
4.4	New in L-INX/L-GATE 6.3.0	32
4.5	New in L-INX/L-GATE 6.2.0	32
4.6	New in L-INX/L-GATE 6.1.0	33
4.7	New in L-INX/L-GATE 6.0.0	36
4.8	New in L-INX/L-GATE 5.3.0	38
4.9	New in L-INX/L-GATE 5.1.0	41
4.10	New in L-INX/L-GATE 5.0.0	44
5	Quick-Start Guide	48
5.1	Hardware Installation	48
5.2	Configuration of the Device	48
5.2.1	IP Configuration via the Web Interface	49
5.2.2	IP Configuration via the LCD Display	50
5.2.3	BACnet Configuration	51
5.2.4	License Activation	51
5.3	Getting Started with the L-INX Configurator	52
5.4	Getting Started with the Gateway	53

5.5	Configuration of the L-IOB I/O Modules	55
5.6	Getting started with logiCAD	56
5.7	Connect with an OPC XML-DA Client	61
5.8	Reset to Factory Defaults	62
6	Hardware Installation	63
6.1	Enclosure	63
6.2	Product Label.....	63
6.3	Mounting	63
6.4	LED signals	64
6.4.1	OPC LED	64
6.4.2	PLC LED.....	64
6.4.3	FT Activity LED	64
6.4.4	MSTP Activity LED.....	65
6.4.5	Modbus LED	65
6.4.6	EXT LED	65
6.4.7	Ethernet Link LED	65
6.4.8	Ethernet Activity LED.....	65
6.4.9	BBMD LED	66
6.4.10	Wink Action	66
6.4.11	Network Diagnostics	66
6.5	Wiring.....	66
7	Concepts	67
7.1	Universal Gateway.....	67
7.2	Data Point Configuration.....	67
7.3	IEC61131 Variables.....	68
8	IEC 61131 – L-LOGICAD.....	69
8.1	Overview.....	69
8.2	Installing logiCAD	69
8.2.1	Softlock License	70
8.2.2	Hardlock License.....	71
8.3	IEC61131 Project Files.....	72
8.4	Working with logiCAD.....	73
8.4.1	Managing Variables	75
8.4.2	Build and Download the IEC61131 Program.....	76
8.4.3	Usage of NVs, Technology Converters	77
8.4.4	IEC61131 Program Cycle Time	78
8.4.5	CPU Overload	79
8.4.6	I/O Driver Settings	79
8.4.7	PLC Conflicts.....	80

8.5	Workflows for the L-INX	81
8.5.1	Starting with Data Points	81
8.5.2	Starting with logiCAD	82
8.5.3	Pre-compiled IEC61131 Program	88
8.6	Additional Features.....	89
8.6.1	Force Update Functionality.....	89
8.6.2	Using UNVT variables	89
8.6.3	Create Your Own Data Type	90
8.6.4	Using Persistent Data Points and Markers.....	92
8.6.5	Using Retain Variables	92
8.6.6	L-INX System Registers, System Time	93
8.6.7	Code Protection.....	93
8.6.8	Using Structured Data Point Members	93
8.6.9	BACnet Server Objects.....	94
8.6.10	Custom Serial Protocols.....	95
9	Firmware Update.....	97
9.1	Firmware Update via the Configurator	97
9.2	Firmware Update via the Web Interface.....	99
9.3	Firmware Update via the USB Port.....	99
10	Troubleshooting.....	100
10.1	Technical Support	100
10.2	Packet Capture	100
11	Application Notes.....	101
11.1	The LSD Tool	101
11.2	Use of Static, Dynamic, and External NVs on a Device	101
12	Security Hardening Guide	102
12.1	Installation Instructions.....	102
12.2	Firmware.....	102
12.3	Ports	102
12.4	Services.....	103
12.5	Upgrade Key Strength	104
12.6	Logging and Auditing	104
13	Specifications.....	106
13.1	Physical Specifications	106
13.1.1	LINX-102/103/112/113/202/203/212/213/215 and LGATE-902	106
13.1.2	LINX-12X/15X/22X, LGATE-95X.....	106
13.2	Resource Limits.....	107
13.2.1	L-INX Models.....	107
13.2.2	L-GATE Models	109

13.3	Removable Media	110
13.3.1	LINX-12X/15X/22X, LGATE-950/951	110
13.4	FCC Warning.....	111
13.5	CE Warning	111
14	References	112
15	Revision History	113

Abbreviations

100Base-T	100 Mbps Ethernet network with RJ-45 plug
Aggregation.....	Collection of several CEA-709 packets into a single CEA-852 packet
AST.....	Alarming, Scheduling, Trending
BACnet	Building Automation and Control Network
BBMD.....	BACnet Broadcast Management Device
BDT	Broadcast Distribution Table
BOOTP	Bootstrap Protocol, RFC 1497
CA.....	Certification Authority
CEA-709	Protocol standard for LONWORKS networks
CEA-852.....	Protocol standard for tunneling CEA-709 packets over IP channels
CN.....	Control Network
COV	change-of-value
CR.....	Channel Routing
CS.....	Configuration Server that manages CEA-852 IP devices
DA.....	Data Access (Web service)
DHCP.....	Dynamic Host Configuration Protocol, RFC 2131, RFC 2132
DIF, DIFE	Data Information Field, Data Information Field Extension
DL	Data Logger (Web service)
DNS	Domain Name Server, RFC 1034
DST.....	Daylight Saving Time
EEP	EnOcean Equipment Profile
GMT.....	Greenwich Mean Time
IP.....	Internet Protocol
IP-852.....	logical IP channel that tunnels CEA-709 packets according CEA-852
LAN	Local Area Network
LSD Tool	LOYTEC System Diagnostics Tool
MAC	Media Access Control
MD5	Message Digest 5, a secure hash function, see Internet RFC 1321
M-Bus	Meter-Bus (Standards EN 13757-2, EN 13757-3)
MIB.....	Management Information Base
MS/TP.....	Master/Slave Token Passing (this is a BACnet data link layer)
NAT	Network Address Translation, see Internet RFC 1631
NV.....	Network Variable
OPC.....	Open Process Control
OPC UA.....	OPC Unified Architecture
PEM	Privacy Enhanced Mail
PLC	Programmable Logic Controller
RNI.....	Remote Network Interface
RSTP.....	Rapid Spanning Tree Protocol (Standard IEEE 802.1D-2004)
RTT.....	Round-Trip Time
RTU	Remote Terminal Unit
SCPT.....	Standard Configuration Property Type

SSH.....	Secure Shell
SL	Send List
SMTP	Simple Mail Transfer Protocol
SNMP	Simple Network Management Protocol
SNTP	Simple Network Time Protocol
SSL.....	Secure Socket Layer
STP	Spanning Tree Protocol (Standard IEEE 802.1D)
TLS.....	Transport Layer Security
UCPT.....	User-defined Configuration Property Type
UI.....	User Interface
UNVT.....	User-defined Network Variable Type
UTC.....	Universal Time Coordinated
VIF, VIFE.....	Value Information Field, Value Information Field Extension
WLAN.....	Wireless LAN
XML	eXtensible Markup Language

1 Introduction

1.1 Overview

The L-INX product family consists of high performance, reliable and secure network infrastructure components that implement an embedded automation server. The different models of the L-INX family contain a number of components and network technologies. As protocols on the control network side, the L-INX implements access to BACnet, CEA-709, KNX, Modbus, and M-Bus. The BACnet models are BTL-certified B-BC devices.

The L-GATE product family is intended for use as universal gateways. They provide a similar user interface and set of protocols as the L-INX family. The L-GATE provides data access to a defined set of data points, which are mapped from one control network technology to another control network technology. In particular, the CEA-709/BACnet Gateway (LGATE-902) implements mappings between a set of CEA-709 network variables (NVs) and a set of standard BACnet server objects. Which NVs are mapped to BACnet objects can be configured by an LNS plug-in or stand-alone configuration software. The LGATE-902 is equipped with a 100-BaseT Ethernet port (IP), an FT-10 port (CEA-709), and an RS-485 port (MS/TP). The device is fully compliant with ANSI/CEA-709 and ENV14908, ANSI/ASHRAE-135-2004 and ISO 16484. The LGATE-95X extends the 902 model with a number of additional protocol ports and supports more data points for the gateway.

Data from the supported network technologies are available as data points in the automation server. Those data points are freely configurable via configuration software, which provides a fast and easy way to configure the L-INX and L-GATE using online network scans, import/export features or device templates. Data points between different network technologies can be connected to each other for data transfer between those network technologies (gateway). Data points are also subject to alarming, trending and scheduling (AST) functions of the automation server. The usage of math objects allows basic calculations and the built-in E-mail client allows the L-INX and L-GATE to transmit e-mails on certain conditions. Generated alarms can be configured to send e-mails to predefined addresses. Alarms can also be stored in a historical *alarm log*. Trended data collected by the device and is available in CSV format and through a dedicated Web service.

An embedded OPC server exposes a defined set of data points as OPC tags. It implements the OPC XML-DA standard OPC XML-DA 1.01, which lets OPC clients access the data points via Web services. For secure OPC communication some L-INX models add an OPC UA server. Which native data points are exposed to OPC can also be configured by the configuration software. AST objects such as schedules are exposed as a set of OPC tags. Using the supplied L-WEB designer, users can easily generate a Web-based visualization for the L-INX.

Only the L-INX family contains a freely programmable controller that can operate on all L-INX data points. The controller application is developed using the provided IEC-61131 compliant design tool.

The L-INX and the L-GATE permanently collect statistical information from the attached network channels (OPC connections, FT traffic, MS/TP token passing, Ethernet traffic, etc.). Using this data, the device is able to detect problems on these channels (overload, lost tokens, connection problems, etc.) and warns the system operator via LEDs (see Section 6.4). An intuitive user interface allows fast and easy network troubleshooting without any additional analysis tools or deep system knowledge. For troubleshooting Ethernet protocols a local and remote Wireshark packet capture can be configured (see Section 10.2).

The built-in Web server allows convenient device configuration through a standard Web browser such as the Internet Explorer or Firefox. The Web interface also provides statistics information for system installation and network troubleshooting. Some devices also have an LCD display, which provides a quick way to configure basic settings of the device via a jog dial. Also available on some L-INX models are ports for SD card memory and a USB peripheral bus.

Some L-INX and L-GATE models are also equipped with a 2-port Ethernet Switch/Hub. In switched mode an Ethernet daisy chain can be built, which reduces cabling effort. The two Ethernet connectors can also be configured to work as two isolated IP interfaces. This can be used to safely connect a local building network while keeping it isolated from WAN access, that exposes some aspects using secure services. By using the external L-WLAN adapter, the device also provides a WLAN interface, which can link to an existing access point, set up its own access point or work in a wireless mesh network.

The L-INX is used for:

- Exposing data of control network devices from different technologies (CEA-709, BACnet, KNX, Modbus, M-Bus) to data points in the automation server,
- Directly connecting I/Os to data points in the automation server,
- exposing data points to OPC tags,
- visualization of data points with the supplied LOYTEC L-WEB software,
- visualization of data points in an OPC XML-DA, UA SCADA package,
- Room control, plant control running IEC61131 programs on data points,
- automatic meter reading applications via M-Bus and Modbus,
- meter gateway to BACnet using pulse counters or M-Bus and Modbus meters,
- browsing data points on the Web interface or LCD display,
- basic automation functions on data points (alarms, trending, scheduling),
- logging alarms,
- sending e-mails on alarms, trend logs, or scheduled events.

The L-GATE is used for:

- Connecting data points between any supported control networks (CEA-709, BACnet, KNX, Modbus, M-Bus) using the universal gateway function,
- browsing data points on the Web interface or LCD display,
- exposing data points to OPC tags,
- basic automation functions on data points (alarms, trending, scheduling),
- logging alarms,
- sending e-mails on alarms, trend logs, or scheduled events,
- gateway for ANSI/CEA-709 network variables (NVs) and configuration properties (CPs),
- gateway for standard (SNVT, SCPT) and user-defined (UNVT, UCPT) types.

1.2 CEA-709.1

L-INX automation server models that have CEA-709 and all L-GATE models are equipped with an FT port (CEA-709) and a 100Base-T Ethernet port (CEA-852). CEA-709 L-INX models come with a router option or an RNI option. L-INX models with the router option contain a CEA-709 router between the FT and the IP-852 channel, which can be configured like an L-IP. It includes a configuration server (CS) to manage the IP-852 channel. The L-INX models without the router option contain a remote network interface (RNI) instead of the router for remote network access. Please refer to Table 1 to learn, which device models have CEA-709 and the router option.

The CEA-709 L-INX and L-GATE device is fully compliant with ANSI/CEA-709, ANSI/CEA-852-A, EN 14908. The CEA-709 node, that is going to be commissioned in the network, is always connected to the FT port of the device.

The function of the CEA-709 node is to expose CEA-709 network variables (NVs) and configuration properties (CPs) to data points in the automation server or the gateway. The configuration software can be run as LNS plug-in or stand-alone. The CEA-709 data points can be bound in the CEA-709 network as NVs or operated as “external NVs”. External NVs are polled or explicitly written to without allocating static or dynamic NVs on the device. In this case, address information is supplied by the configuration software by importing e.g., a CSV file. User-defined network variable types (UNVTs) can be used as dynamic or external NVs. Configuration properties (CPs) on other devices can be accessed through file transfer. To transfer CPs, the device supports both the LONMARK file transfer and the read memory access method. For CPs, the standard SCPTs and user-defined UCPTs are supported. All those CEA-709 data points can be exposed to the automation server or the gateway.

The CEA-709 L-INX with the router option possesses a router between the CEA-852 interface (IP-852) and the FT interface. The CEA-852 interface can be used to connect the L-INX to an IP-based high-speed backbone. The L-INX’s router can be used as a standard CEA-709 configured router or it can be used as a self-learning plug&play router based on the high-performance, well-proven routing core from our L-Switch plug&play multi-port router devices (“smart switch mode”). The self-learning router doesn’t need a network management tool for configuration but is a true plug&play and easy to use IP infrastructure component. For a detailed description of the CEA-709 router’s usage refer to the L-IP User Manual [8].

The L-GATE and the CEA-709 L-INX without the router option can be configured to run either on the CEA-852 interface (IP-852 mode) or on the FT interface (FT mode). In the FT mode, the device provides a remote network interface (RNI), which appears like a LOYTEC NIC-IP is intended to be used together with the LOYTEC NIC software [3]. The RNI can be utilized for remote access and configuration as well as trouble-shooting with the remote LPA. Please consult our product literature for the LPA-IP to learn more about this IP-based CEA-709 protocol analyzer.

The CEA-709 technology in the L-INX and L-GATE allows for:

- Exposing CEA-709 network variables (NVs) and configuration properties (CPs) as data points to the automation server or gateway,
- supporting standard (SNVT, SCPT) and user-defined (UNVT, UCPT) types,
- scheduling CEA-709 network variables,
- generating alarms over the LONMARK node object,
- CEA-709 PC applications (as a CEA-709 network interface),
- remote LPA functionality,
- communicating on CEA-709 with either FT or IP-852 (IP channel on the Intranet/Internet),

- connecting an FT channel to a high-performance backbone using existing IP infrastructure,
- operating as a configuration server for IP-852 devices with the router option.

1.3 BACnet

L-INX automation server models that have BACnet and all L-GATE models are BTL-certified products that implement the B-BC profile. They are equipped with an MS/TP port and a 100Base-T Ethernet port (BACnet/IP). The MS/TP port supports remote Wireshark packet capture for troubleshooting. BACnet L-INX models with the router option also contain a BACnet router between the MS/TP and the BACnet/IP ports, which can be configured like an LIP-ME201. The router models also include a BACnet broadcast management device (BBMD) to manage BACnet/IP internetworks, which span across IP routers. BACnet models without the router can register as a foreign device (FD) with other BBMDs. The device is fully compliant with ANSI/ASHRAE 135-2010 (1.7) and ISO 16484-5. Please refer to Table 1 to learn, which device models have BACnet and the router option.

The BACnet L-INX and the L-GATE expose BACnet server objects and client mappings to data points of the automation server or the gateway. For client mappings, the BACnet address information is supplied by the configuration software by importing e.g., a CSV file or by performing an online network scan.

The BACnet L-INX and L-GATE models also support the LOYTEC Alarming, Scheduling and Trending (AST) features in native BACnet objects. The device provides BACnet scheduler/calendar objects, which can directly schedule BACnet server objects, remote BACnet objects or non-BACnet registers. For alarm conditions the device supports the intrinsic reporting method of BACnet objects. Trend logs can be uploaded from the device via the native BACnet read range.

The BACnet L-INX with the router option possesses a BACnet router between the BACnet/IP port and the MS/TP port. This router can be operated and configured like the LIP-ME200 from LOYTEC. The BACnet/IP interface can be used to connect the L-INX to an IP-based high-speed backbone. The L-INX also can act as a BBMD for a BACnet/IP network. For a detailed description of the BACnet router's usage refer to the LIP-ME201 User Manual [9].

A BACnet L-INX without the router option and the L-GATE can be configured to run either on the BACnet/IP interface or on the MS/TP interface. In BACnet/IP mode, the L-INX can be configured as a foreign device in another BBMD. The BACnet L-INX without the router option does not provide the BBMD functionality itself. The L-GATE can also be configured to be a BBMD. Please refer to Table 1 to learn, which models can be configured as a BBMD.

The BACnet technology in the L-INX and L-GATE allows for:

- Using the device as a BTL-certified B-BC,
- exposing local BACnet server objects (analog, binary, multi-state) and remote objects (client mappings) to data points,
- scheduling any data point from native BACnet schedule and calendar objects,
- trending any data point to native BACnet trend log objects,
- generating native BACnet alarms on any data point,
- communicating with either MS/TP or BACnet/IP,
- connecting an MS/TP network to a high-performance backbone using existing IP infrastructure,
- operation as a BBMD for a BACnet/IP network with the router option,

- troubleshoot the MS/TP network with Wireshark remote packet capture (see Section 10.2),
- distributing NTP time into the BACnet network as BACnet time master.

1.4 M-Bus

In addition to the basic network technologies all models except the LGATE-900 support the M-Bus interface according to the standards EN 13757-2 and EN 13757-3. To get access to the M-Bus network, an external M-Bus interface such as the L-MBUS by LOYTEC must be attached to the device. On devices with a serial port, the M-Bus interface is connected to the serial connector. In this case the user needs to turn M-Bus support on and off via a DIP switch. On devices without a serial port, the L-MBUS interface must be used and is connected to the extension port (EXT).

Through the M-Bus interface the L-INX can be used to scan the attached M-Bus network for devices, pull M-Bus data points into a configuration, connect those data points to other technologies and expose M-Bus data points to the automation server. All AST functions can be used directly on M-Bus data points. Especially trending data and polling for data on M-Bus devices has been optimized for automatic meter reading applications.

For debugging purposes a protocol analyzer is included in the firmware and can be operated via the Web-UI and the configuration software. For more information on how to set up the device for using M-Bus, configuring and using M-Bus data points, refer to the M-Bus Chapter in the LINX Configurator User Manual [2].

1.5 Modbus

In addition to the basic network technologies the all models support the Modbus RTU and the Modbus TCP interface. To get access to the Modbus network, the appropriate interfaces have to be activated either in the Web UI or in the configuration software. Modbus RTU is operated with 8N1. A Modbus port can either be operated as Modbus master or Modbus slave.

On some BACnet L-INX models, the Modbus RTU and BACnet MS/TP protocols share the same port. On those models, Modbus RTU can only be used, if BACnet MS/TP is disabled. Please refer to Table 1 to learn, which BACnet L-INX models have this restriction.

Through the Modbus interface the device can be used to data points to other technologies, and expose Modbus data points to OPC tags. All AST functions can be used directly on Modbus data points. Especially trending data and polling for data on Modbus devices has been optimized for automatic meter reading applications.

For debugging purposes a protocol analyzer is included in the firmware and can be operated via the Web UI and the configuration software. For more information on how to set up the device for using Modbus, configuring and using Modbus data points, refer to the Modbus Chapter in the LINX Configurator User Manual [2].

1.6 KNX

In addition to the basic network technologies, some L-INX and L-GATE models can be connected to KNX networks (see Section 1.12). To gain access to a KNX TP1 network, the LKNX-300 interface has to be attached to the device for TP1 networks. All KNX-capable models support KNXnet/IP directly with their Ethernet interface.

The KNX interface allows creating KNX data points which can be used with the AST functions, the OPC server and also the PLC on the L-INX models. The device configuration can be imported from an ETS database export.

For more information on how to set up the device for using KNX, configuring and using KNX data points, refer to the KNX Chapter in the LINX Configurator User Manual [2].

1.7 EnOcean

In addition to the basic network technologies, some L-INX and L-GATE models can integrate EnOcean wireless devices (see Section 1.12). To gain access to an EnOcean network, the LENO-800 interface has to be attached via one of the USB ports USB 1 or USB 2.

The EnOcean interface is represented in the Configurator as a technology folder. EnOcean devices are created from device templates and provide data points, which can be used with the AST functions, the OPC server and also the PLC on the L-INX models.

For debugging purposes a protocol analyzer is included in the firmware and can be operated via the Web UI. For more information on how to set up the device for using EnOcean, configuring and using EnOcean data points, refer to the EnOcean Chapter in the LINX Configurator User Manual [2].

1.8 SMI

In addition to the basic network technologies, some L-INX and L-GATE models can be connected to SMI networks (see Section 1.12). To get access to the SMI network, the LSMI-800 interface has to be attached to the EXT port of the device (for one SMI channel), or the LSMI-804 interface to the USB port (for four SMI channels).

The SMI interface is represented in the Configurator as a technology folder. SMI devices are created from device templates and provide data points, which can be used with the AST functions, the OPC server and also the PLC on the L-INX models.

For debugging purposes a protocol analyzer is included in the firmware and can be operated via the Web UI. For more information on how to set up the device for using SMI, configuring and using SMI data points, refer to the SMI Chapter in the LINX Configurator User Manual [2].

1.9 MP-Bus

In addition to the basic network technologies, some L-INX and L-GATE models can be connected to MP-Bus networks (see Section 1.12). To get access to the MP-Bus network, the LMPBUS-804 interface has to be attached to the built-in USB ports USB 1 and USB 2. Up to two LMPBUS-804 interfaces can be operated at the same time, covering a maximum of 8 MP-Bus channels. External USB hubs are not supported.

The MP-Bus interface is represented in the Configurator as a technology folder. MP-Bus devices are created from device templates and provide data points, which can be used with the AST functions, the OPC server and also the PLC on the L-INX models.

For debugging purposes a protocol analyzer is included in the firmware and can be operated via the Web UI. For more information on how to set up the device for using MP-Bus, configuring and using MP-Bus data points, refer to the MP-Bus Chapter in the LINX Configurator User Manual [2].

1.10 L-IOB

The L-INX automation server models allow connecting physical I/Os to the device via the L-IOB I/O modules (see Table 1). On some models those modules can be stacked up directly to the L-INX using the LIOB-Connect feature (see Section 1.12). The connected I/O modules are automatically identified and coupled as data points into the L-INX automation server. All L-INX models also support easy integration of L-IOB I/O modules over FT cabling using the LIOB-FT feature, or over Ethernet using the LIOB-IP feature.

L-IOB modules are available with digital inputs and outputs, analog inputs and outputs and universal inputs that are configurable. Some models are also available with a differential pressure sensor.

The I/O modules can be parameterized over the configuration software or the Web UI. All parameterization data is stored on the L-INX and can be reloaded to the LIOB modules when needed. The exchange of modules is detected automatically. For more information on how to setup and use L-IOB I/Os please refer to the L-IOB user manual [7].

1.11 Scripting

Select programmable L-INX and L-GATE models provide a JavaScript-based scripting engine (see Table 1 and Table 2). On some of them, a license (L-IOT1) needs to be purchased to enable the feature. The script engine allows users to implement custom protocols using RESTful APIs, JSON, Web services for IoT integration into the LOYTEC data point model. The dpal-js API gives JavaScript modules access to the data point server. Script modules are embedded into and deployed along with the data point configuration.

The Web interface of the LOYTEC device offers an overview of installed script modules and allows starting scripts in debug mode. The debug mode implements the inspector interface of Google Chrome to debug JavaScript on the device. For more information read the new Scripting Chapter in the LINX Configurator User Manual [2].

1.12 L-INX and L-GATE Models

This Section provides an overview of the different L-INX and L-GATE models in Table 1 and Table 2. This table identifies the different features of those models. Models that possess a certain feature have a check mark (✓) in the respective column. If a feature is not available in the particular model, the column is left blank.

L-INX models with the router option have a CEA-709 router or a BACnet router, respectively. The LINX-151 has both a CEA-709 router between FT and IP and a BACnet router between MS/TP and IP.

Model \ Features	LINX-102	LINX-103	LINX-112	LINX-113	LINX-120	LINX-121	LINX-150	LINX-151	LINX-153	LINX-154
CEA-709 Router		✓		✓		✓		✓	✓	
CEA-709 RNI	✓		✓		✓		✓		✓	
CEA-709 (FT)	✓ ¹	✓	✓ ¹	✓	✓ ¹	✓	✓ ¹	✓	✓ ¹	
CEA-852 (IP)	✓ ¹	✓	✓ ¹	✓	✓ ¹	✓	✓ ¹	✓	✓ ¹	✓
BACnet Router								✓	✓	✓
BACnet MS/TP							✓ ²	✓	✓	✓
BACnet IP							✓ ²	✓	✓	✓
BBMD								✓	✓	✓
Modbus RTU	✓	✓	✓	✓	✓	✓	✓ ³	✓ ³	✓	✓
Modbus IP	✓	✓	✓	✓	✓	✓	✓	✓	✓	✓
M-Bus	✓ ⁴	✓ ⁴	✓ ⁴	✓ ⁴	✓ ⁴	✓ ⁴	✓ ⁴	✓ ⁴	✓ ⁴	
SMI	✓ ⁴	✓ ⁴	✓ ⁴	✓ ⁴	✓ ⁴	✓ ⁴	✓ ⁴	✓ ⁴	✓ ⁴	
KNX TP1	✓ ⁴	✓ ⁴	✓ ⁴	✓ ⁴	✓ ⁴	✓ ⁴	✓ ⁴	✓ ⁴	✓ ⁴	
KNX IP	✓	✓	✓	✓	✓	✓	✓	✓	✓	
EnOcean	✓ ⁵	✓ ⁵	✓ ⁵	✓ ⁵	✓ ⁵	✓ ⁵	✓ ⁵	✓ ⁵	✓ ⁵	
MP-Bus (8 channels)	✓ ⁵	✓ ⁵	✓ ⁵	✓ ⁵	✓ ⁵	✓ ⁵	✓ ⁵	✓ ⁵	✓ ⁵	
OPC XML-DA	✓	✓	✓	✓	✓	✓	✓	✓	✓	✓
OPC UA	✓	✓	✓	✓	✓	✓	✓	✓	✓	✓
OPC Client	✓	✓	✓	✓	✓	✓	✓	✓	✓	✓
SNMP	✓	✓	✓	✓	✓	✓	✓	✓	✓	✓
PLC (L-LOGICAD)			✓	✓	✓	✓	✓	✓	✓ ⁶	✓ ⁶
PLC (L-STUDIO)			✓ ⁶	✓ ⁶					✓	✓
LIOB Connect	✓	✓	✓	✓	✓	✓	✓	✓	✓	
LIOB FT + IP	✓	✓	✓	✓	✓	✓	✓	✓	✓	✓
LCD Display	✓	✓	✓	✓	✓	✓	✓	✓	✓	✓
SD Card					✓	✓	✓	✓		
USB	✓	✓	✓	✓	✓	✓	✓	✓	✓	✓
Ethernet Switch/Hub	✓	✓	✓	✓	✓	✓	✓	✓	✓	✓
WLAN, LTE	✓ ⁵	✓ ⁵	✓ ⁵	✓ ⁵	✓ ⁵	✓ ⁵	✓ ⁵	✓ ⁵	✓ ⁵	✓ ⁵
SSH, HTTPS, Firewall	✓	✓	✓	✓	✓	✓	✓	✓	✓	✓
Script Support	✓ ⁶	✓ ⁶	✓	✓					✓	✓

¹ This model can be configured to have either FT or IP active for CEA-709.

² This model can be configured to have either MS/TP or IP active for BACnet.

³ Modbus RTU can only be used, if BACnet MS/TP is not active on this model.

⁴ M-Bus, SMI and KNX TP1 can be used alternatively only on this model. To operate these protocols an expansion module is needed and must be ordered separately. LSMI-804 can be connected independently.

⁵ To operate these protocols an expansion module is needed and must be ordered separately.

⁶ These models require a separate license that needs to be purchased to use this feature.

Table 1: Available features in different L-INX and L-GATE models.

On L-INX models without the router option and on all L-GATE models, certain ports can only be used alternatively. On models with CEA-709 this means either as CEA-709 FT or as CEA-852 IP (see note 1 in Table 1 and Table 2). On models with BACnet this means either

as BACnet MS/TP or as BACnet IP (see note 2 in Table 1 and Table 2). Some BACnet models have a restriction on Modbus RTU and BACnet MS/TP as they share the same port. On those models Modbus RTU can only be used, if BACnet MS/TP is disabled (see note 3 in Table 1 and Table 2).

Model \ Features	LINX-202	LINX-203	LINX-212	LINX-213	LINX-215	LINX-220	LINX-221	LGATE-902	LGATE-950	LGATE-951	LGATE-952
CEA-709 Router					✓						
CEA-709 RNI					✓			✓	✓	✓	✓
CEA-709 (FT)					✓ ¹			✓ ¹	✓ ¹	✓ ¹	✓ ¹
CEA-852 (IP)					✓ ¹			✓ ¹	✓ ¹	✓ ¹	✓ ¹
BACnet Router		✓		✓	✓	✓	✓				
BACnet MS/TP	✓ ²	✓	✓ ²	✓	✓	✓	✓	✓ ²	✓ ²	✓ ²	✓ ²
BACnet IP	✓ ²	✓	✓ ²	✓	✓	✓	✓	✓ ²	✓ ²	✓ ²	✓ ²
BBMD		✓		✓	✓	✓	✓	✓	✓	✓	✓
Modbus RTU	✓ ³	✓ ³	✓ ³	✓ ³	✓	✓	✓	✓ ³	✓	✓ ³	✓
Modbus IP	✓	✓	✓	✓	✓	✓	✓	✓	✓	✓	✓
M-Bus	✓ ⁴	✓ ⁴	✓ ⁴	✓ ⁴	✓ ⁴	✓ ⁴	✓ ⁴	✓ ⁴	✓ ⁴	✓	✓
SMI	✓ ⁴	✓ ⁴	✓ ⁴	✓ ⁴	✓ ⁴	✓ ⁴	✓ ⁴	✓ ⁴	✓ ⁴	✓	✓
KNX TP1	✓ ⁴	✓ ⁴	✓ ⁴	✓ ⁴	✓ ⁴	✓ ⁴	✓ ⁴	✓ ⁴	✓ ⁴	✓	✓
KNX IP	✓	✓	✓	✓	✓	✓	✓	✓	✓	✓	✓
EnOcean	✓ ⁵	✓ ⁵	✓ ⁵	✓ ⁵	✓ ⁵	✓ ⁵	✓ ⁵	✓ ⁵	✓ ⁵	✓ ⁵	✓ ⁵
MP-Bus (8 channels)	✓ ⁵	✓ ⁵	✓ ⁵	✓ ⁵	✓ ⁵	✓ ⁵	✓ ⁵	✓ ⁵	✓ ⁵	✓ ⁵	✓ ⁵
OPC XML-DA	✓	✓	✓	✓	✓	✓	✓	✓	✓	✓	✓
OPC UA	✓	✓	✓	✓	✓	✓	✓	✓	✓	✓	✓
OPC Client	✓	✓	✓	✓	✓	✓	✓	✓	✓	✓	✓
SNMP	✓	✓	✓	✓	✓	✓	✓	✓	✓	✓	✓
PLC (L-LOGICAD)			✓	✓	✓ ⁶	✓	✓				
PLC (L-STUDIO)			✓ ⁶	✓ ⁶	✓						
LIOB Connect	✓	✓	✓	✓	✓	✓	✓				
LIOB FT + IP	✓	✓	✓	✓	✓	✓	✓				
LCD Display	✓	✓	✓	✓	✓	✓	✓	✓	✓	✓	✓
SD Card						✓	✓		✓	✓	
USB	✓	✓	✓	✓	✓	✓	✓	✓	✓	✓	✓
Ethernet Switch/Hub	✓	✓	✓	✓	✓	✓	✓	✓	✓	✓	✓
WLAN, LTE	✓ ⁵	✓ ⁵	✓ ⁵	✓ ⁵	✓ ⁵	✓ ⁵	✓ ⁵	✓ ⁵	✓ ⁵	✓ ⁵	✓ ⁵
SSH, HTTPS, Firewall	✓	✓	✓	✓	✓	✓	✓	✓	✓	✓	✓
Script Support	✓ ⁶	✓ ⁶	✓	✓	✓			✓			✓

¹ This model can be configured to have either FT or IP active for CEA-709.

² This model can be configured to have either MS/TP or IP active for BACnet.

³ Modbus RTU can only be used, if BACnet MS/TP is not active on this model.

⁴ M-Bus, SMI and KNX TP1 can be used alternatively only on this model. To operate these protocols an expansion module is needed and must be ordered separately. LSMI-804 can be connected independently.

⁵ To operate these protocols an expansion module is needed and must be ordered separately.

⁶ These models require a separate license that needs to be purchased to use this feature.

Table 2: Available features in different L-INX and L-GATE models (continued).

The LGATE-951 has two EXT ports and therefore can operate M-Bus and KNX TP1 at the same time, while the LGATE-950 can use either M-Bus or KNX TP1. The LGATE-952 has two RS-485 and three EXT ports.

1.13 Scope

This document covers L-INX and L-GATE devices with firmware version 7.2 and describes specific functions of those device models. Basic device operations are covered in the LOYTEC Device User Manual [1] and data point configuration is covered by the L-INX Configurator User Manual [2]. The usage of logiCAD itself is beyond the scope of this manual. Please refer to the logiCAD online help in case of additional questions.

2 Disclaimer Cyber Security

LOYTEC offers a portfolio of products, solutions and systems with cyber security functions that enable the secure operation of devices, systems and networks in the field of building automation and control technology. To ensure that devices, systems, and networks are always protected against online threats, a holistic security concept is required that is implemented using the latest technology and is being kept up-to-date. The LOYTEC portfolio is only one component of such an overall concept.

The customer is responsible for preventing unauthorized access to the devices, systems and networks. These should only be connected to a network or the Internet if adequate security measures are in place (e.g. firewalls, separate networks) and a connection is required for operation. In addition, LOYTEC's recommendations for securing devices in the Security Hardening Guide (Chapter 12) must be followed. For additional information, please contact your support person at LOYTEC or visit our website.

LOYTEC is constantly working on improving the existing products in order to follow the latest cyber security standards. Therefore, LOYTEC strongly recommends installing updates as soon as they become available and always using the latest software versions. LOYTEC explicitly points out that using older versions or refraining from updates increases the risk of online security threats.

3 Safety Instructions

	ATTENTION
	<p>General Safety Instructions</p> <p>Please regard the following general instructions for project planning and execution:</p> <ul style="list-style-type: none"> • Regard all measures or prohibitions of the respective country to avoid danger of electricity and high voltage. • Other relevant regulations of the respective country. • House installation regulations of the respective country. • Regulations of the utility company. • Any specifications, diagrams, dispositions, cable lists and regulations of the customer or system integrator. • Any third-party regulations (e.g., general contractor or client).

	ATTENTION
	<p>Country-specific Safety Regulations</p> <p>Failure to observe country-specific safety regulations can lead to property damage and personal injury. Therefore, comply with the country-specific regulations and the corresponding safety guidelines.</p>

	CAUTION
	<p>Electrical Safety</p> <p>Essentially, electrical safety in building automation systems from LOYTEC is based on the use of extra-low voltage and safe isolation from mains voltage.</p>

	CAUTION
	<p>IEC (SELV, PELV) (world-wide)</p> <p>Depending on the extra-low voltage earthing (24VAC), this results in an application according to SELV or PELV in accordance with IEC 60364-4-41:</p> <ul style="list-style-type: none"> • Ungrounded = SELV (Safety Extra Low Voltage), • Earth ground = PELV (Protected Extra Low Voltage).

	CAUTION
	<p>NEC (North America)</p> <p>Class 2 transformers with energy limitation to 100 VA or Class 2 circuits with max. 100 VA (using a non-energy-limiting transformer of max. 400VA) combined with overcurrent limits (T-4A fuses) can be used for each individual 24VAC device. Several fuses for several isolated secondary circuits per transformer are possible. The same applies to power supplies with 24VDC.</p>

	CAUTION
	<p>Device Safety</p> <p>Device safety is guaranteed by supply with low voltage 24VAC or 24VDC and a double insulation between mains voltage 230VAC, 24VAC circuits and the housing or by supply via Power over Ethernet (PoE Class 1). In addition, the specific regulations for electrical wiring according to this manual must be observed.</p>

	CAUTION
	<p>Earth Ground of \perp (System Zero AC/DC 24V)</p> <p>The following items must be observed when earth-grounding system zero \perp 24VAC:</p> <ul style="list-style-type: none"> • In principle, both earth-grounding and non-grounding of system zero of the operating voltage 24VAC is permitted. Important are the local regulations and customs. Due to functional requirements, earth ground may be necessary or inadmissible. • It is recommended to ground 24VAC systems unless this contradicts the manufacturer's instructions. • To avoid earth loops, systems with PELV may only be connected to earth ground at one point in the system. Unless otherwise stated, usually at the transformer. • The same applies to 24VDC power supplies.





	CAUTION
	<p>Functional Earth \oplus</p> <p>Functional earth must be connected to the building's protective earthing (PE) system on the installation side.</p>

	CAUTION
	<p>Operating Voltage 24V AC/DC</p> <p>The power supply must meet the requirements for SELV or PELV. Permitted deviation of the nominal voltage:</p> <ul style="list-style-type: none"> • At the transformer or power supply: 24V AC/DC -10 ... + 10% • At the device: 24V AC or DC ± 10 %

	CAUTION
	<p>Specification for 24VAC Transformers</p> <p>IEC: safety transformers according to IEC 61558 with double insulation, designed for 100% duty cycle to supply SELV or PELV circuits.</p> <p>U.S.: Class 2 circuits according to UL 5085-3.</p> <p>For efficiency reasons, the power drawn from the transformer should be at least 50% of the nominal load.</p> <p>The nominal power of the transformer must be at least 25 VA. Using a transformer of smaller size, the ratio of open circuit voltage to voltage at full load becomes unfavorable ($> + 20\%$).</p>

	CAUTION
	<p>Specification for 24VDC Power Supplies</p> <p>Power supplies must be designed for 100% duty cycle to supply SELV or PELV circuits.</p> <p>U.S.: Class 2 circuits according to UL 5085-3.</p> <p>For efficiency reasons, the power drawn from the power supply should be at least 50% of the nominal load.</p>

	CAUTION
	<p>Protection of the 24VAC Supply Voltage</p> <p>Transformers must be protected on the secondary circuit, according to the transformer dimensions and the effective load of all connected devices:</p> <p>Always protect the 24VAC conductor (system potential),</p> <p>Additionally protect the conductor \perp (system zero) where required.</p>

	CAUTION
	Protection of the 24VDC Supply Voltage 24VDC power supplies must be short-circuit proof or have an internal microfuse. Local regulations must be observed.
	CAUTION
	Protection of Mains Voltage Transformers/24VDC power supplies must be protected on the primary circuit using a control cabinet fuse.
	CAUTION
	Power over Ethernet (PoE) LPAD-7 Touch Panels require a PoE Class 1 power supply (max. 12W), which must be compliant to IEEE 802.3at-2009. For the power supply of the PoE switches observe the manufacturer's specifications.
	CAUTION
	Attention to External Voltages Any kind of introduction or spreading of dangerous voltages onto the low-voltage circuits of the system (e.g. due to incorrect wiring) must be avoided at any circumstance and represents an immediate life danger or can lead to the entire or partial destruction of the building automation system.

4 What's New in L-INX/L-GATE

4.1 New in L-INX/L-GATE 7.2.0

This section describes the major changes and new features. For a full list of changes refer to the Readme file.

Support for LTE

LOYTEC devices now support the LTE-800 mobile interface. This interface is connected via the USB port and offers LTE/UMTS/GSM mobile network access. A SIM card from your provider needs to be inserted and the LOYTEC device is ready on the mobile network. A **Mobile** tab has been added to the port configuration interface for configuring the LTE-800. Simply enable Mobile Network, enter your APN data and select which protocols shall be run on LTE.

New system registers offer mobile communication statistics such as Bytes transferred or SMS sent. The VPN client is also ready to be used on the LTE mobile network.

Figure 1: LTE-800 mobile configuration

Internet Connection Sharing

Combined with an LTE-800 mobile interface a LOYTEC device can act as a NAT router to share the mobile Internet connection with other devices on the LAN. For doing so, the **Internet connection sharing** feature can be enabled on the **IP Host** tab, where the default router interface is selected. Other devices on the LAN need to specify the IP address of the LOYTEC device offering connection sharing as their default gateway. This way, local devices can use NTP, VPN client or other Internet services.

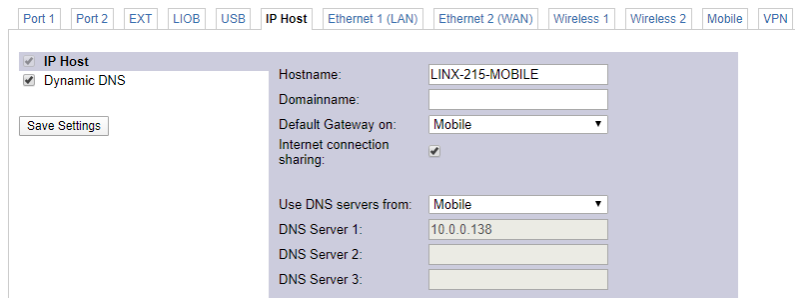

The screenshot shows the 'IP Host' configuration page. The 'Dynamic DNS' checkbox is checked. The 'Save Settings' button is visible. The configuration fields are as follows:

Hostname:	LINX-215-MOBILE
Domainname:	
Default Gateway on:	Mobile
Internet connection sharing:	<input checked="" type="checkbox"/>
Use DNS servers from:	Mobile
DNS Server 1:	10.0.0.138
DNS Server 2:	
DNS Server 3:	

Figure 2: Internet connection sharing

Dynamic DNS

LOYTEC devices can now make use of a dynamic DNS service to register a public DNS name. This makes the device reachable over a public IP address that can change over time, for instance an LTE-800 mobile interface using a public IP address assigned by the mobile carrier. A number of dynamic DNS providers are preconfigured and can be selected on the **IP Host** tab of the port configuration as shown in Figure 3.

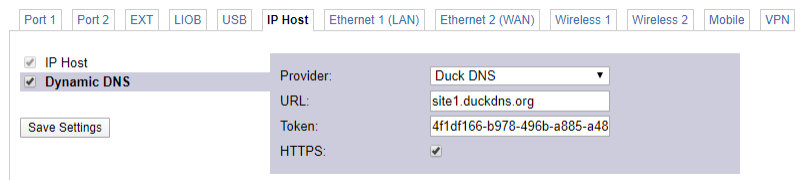

The screenshot shows the 'IP Host' configuration page with 'Dynamic DNS' selected. The 'Save Settings' button is visible. The configuration fields are as follows:

Provider:	Duck DNS
URL:	site1.duckdns.org
Token:	4f1df166-b978-496b-a885-a48
HTTPS:	<input checked="" type="checkbox"/>

Figure 3: Dynamic DNS Settings

Secure Building Automation Protocols using VPN

This firmware version enhances flexibility and control over which building automation protocols are directly available on the VPN. A separate **VPN** tab has been added to the port configuration that allows configuring IP-based control protocols to be running directly on the VPN client. This effectively secures otherwise unsecured automation protocols such as BACnet/IP, Modbus TCP, KNXnet/IP or CEA-852. When running on the VPN interface, the protocols are assigned the VPN's IP address and as a protocol node, the LOYTEC device is also reachable over multi-NAT access networks, such as LTE.

For example, simply set up the CEA-852 configuration server on the VPN interface and add all other CEA-852 clients on the same VPN. The same can be done for BACnet/IP. Each node establishes a secure channel to the OpenVPN server hub, which routes the traffic between the communicating peer nodes. No unencrypted traffic will ever be transmitted.

Figure 4: VPN tab on the port configuration interface.

SMS Delivery

The new SMS template message type can be used to configure SMS transmission just like E-Mail templates for E-Mail transmission. SMS can be triggered and contain arbitrary variable text and placeholders. One application is SMS alarm delivery.

Figure 5: SMS template configuration.

SMS can be sent using a locally attached LTE-800 mobile interface or over the network using another LOYTEC device acting as an SMS proxy for its LTE-800 mobile interface. SMS proxy mode can be configured in the new SMS configuration menu on the Web UI. As a result, only one LTE-800 is required to offer SMS service for an entire local network.

Node-RED™ Integration

LOYTEC devices that support the scripting feature now also natively integrate the Node-RED™ run-time. The Web interface provides a configuration menu to open the Node-RED™ editor UI. As a default, the run-time is not executing and needs to be enabled. Once enabled, the run-time automatically starts the configured flows. An example is shown in Figure 6.

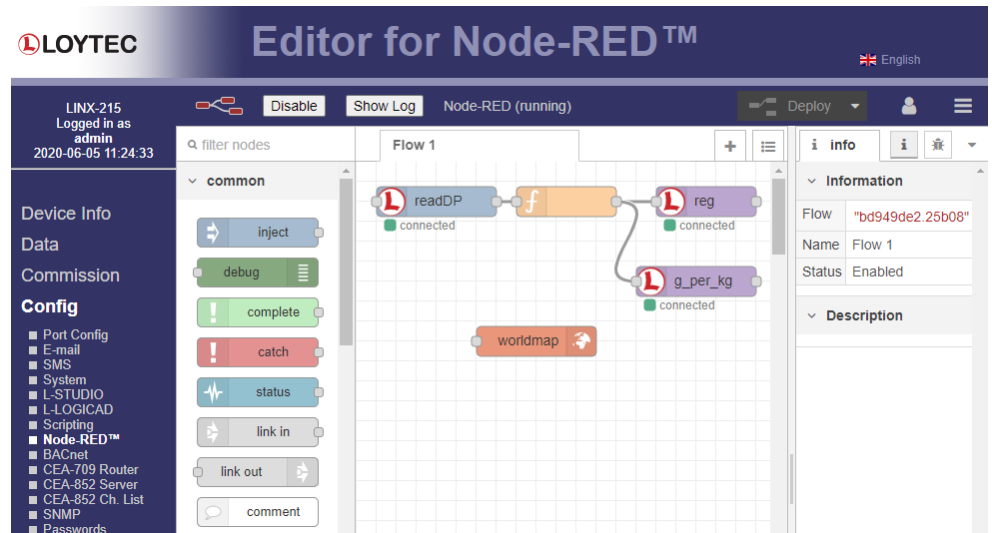

Figure 6: Node-RED™ editor UI on the device.

The user can access data points on the device using the pre-installed ‘readDP’ and ‘writeDP’ palette items. Custom palette items can also be installed, like the ‘worldmap’. The editor UI is also accessible on a stand-alone Web browser page under the ‘/nodered’ device URL.

Parameter and Default Values

A new *Parameter Value* property has been introduced in the data point configuration that tracks the current parameter value on the device. This is in addition to the *Default Value* property. When uploading parameter values from the device into the configuration, the parameter value property is updated where selected so in the parameter merge dialog. The default value property remains unaffected by a parameter upload. This way it is possible to track current parameter values while still keeping their original default values. When desired, parameter values can be reset to their default values.

Name	Value	Description
Datapoint Path	User Registers.param1	Path to the data point in the hierarchy
Datapoint Type	Double	Class type of the data point
Default Value	<input checked="" type="checkbox"/> 10	Default value when starting up
Parameter	<input checked="" type="checkbox"/>	Make available as a parameter
Parameter Value	21	Effective parameter value
Persistent	<input checked="" type="checkbox"/>	Make the data point value persistent over power-on resets

Figure 7: The new Parameter Value property.

New universal IN/OUT Analog/Digital L-IOB Terminal Type

With the introduction of the LIOB-110/LIOB-590 models, a new L-IOB I/O terminal hardware type has been introduced: a universally configurable IN/OUT Analog/Digital terminal. The signal type of this terminal determines whether it is an input (measure resistance, current, voltage) or an output (drive 0-10V voltage output). Within its signal type class, the known signal interpretations can be configured (e.g. PT1000, linear, translation table).

IPv6

LOYTEC devices now support IPv6 using stateless address autoconfiguration (SLAAC) or having a configured, fixed IPv6 address. The IPv6 feature is available on all Ethernet and WLAN ports. With SLAAC no further configuration (except the required IPv6 router

equipment) is required. The static IPv6 address can be configured on the TCP/IP settings on the port configuration.

Protocols that support IPv6 are the Web interface, SSH, HTTPS, NTP and BACnet/IPv6. Additional IPv6 statistics have been added to the IP statistics pages for troubleshooting.

BACnet Dynamic Object Creation and Event Enrollment

New BACnet protocol features have been added to LOYTEC devices. First, dynamic object creation is now supported for Trend_Log, Scheduler, Calendar, Notification_Class objects. This means that a BACnet OWS can dynamically create and delete those objects during run-time. No reserved BACnet objects are required in the data point configuration.

Second, algorithmic reporting has been implemented in the Event_Enrollment object. This object can be created and configured by a BACnet OWS to dynamically add and remove alarm conditions on any BACnet object in the device.

In combination with IPv6 support, the BACnet protocol can be configured to run on the BACnet/IPv6 data link. Simply choose IPv6 in the BACnet/IP protocol configuration.

4.2 New in L-INX/L-GATE 7.0.0

This section describes the major changes and new features. For a full list of changes refer to the Readme file.

Support two LMPBUS-804

Up to two LMPBUS-804 interfaces can now be connected to the built-in USB ports of the LOYTEC device. This increases the maximum number for supported MP-Bus channels from 4 to 8. Note, that no external USB hubs are supported. The LMPBUS-804 interfaces need to be directly attached to the two built-in USB ports.

Alarming

The data point alarming brings two new features for alarm messages: First, the new placeholders `%{bacName}`, `%{bacDescr}` have been added. These expand to the native BACnet server object name and description. Since these may be updated by an OWS at run-time, alarm messages will now reflect those updates when using the new placeholders.

Another change to alarmed data points are new property relation data points for alarm message texts: `msgNormal`, `msgOffnormal`, `msgHigh`, `msgLow`, and `msgFault`. The content of these property data point overwrite the pre-configured alarm messages and can be changed at run-time. This allows easy configuration of alarm messages by linking to common string data points that are parameters. For example, all temperature alarms may link their `msgHigh` property relation to the string parameter `msgTempHigh` configured to a local text such as "Temperature `%{name}` exceeds `%{hi}`".

VPN

LOYTEC devices support joining a virtual private network (VPN). This feature is based on the widely-used and open-protocol OpenVPN technology. An OpenVPN configuration file (`.ovpn`) can be installed on the Web interface and makes the LOYTEC device a VPN client and dial into the OpenVPN server defined by that file. Any standard OpenVPN configuration file can be used, which is auto-login, i.e. does not require entering a password when connecting. After having registered, the LOYTEC device can be reached via its VPN address.

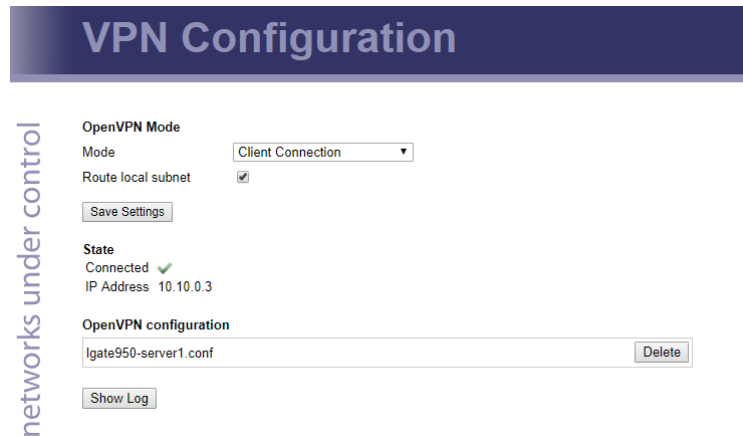

Figure 8: VPN client configuration on the Web interface

Setting up a VPN client on the LOYTEC device may solve NAT router issues, because no port forwarding rules need to be configured. The device dials out to the OpenVPN server running on a public IP and establishes the VPN channel. This VPN channel provides a secure connection for building automation protocols, such as BACnet/IP, Modbus TCP or CEA-852. Being part of a VPN the LOYTEC device is also reachable over multi-NAT access networks, such as LTE.

An alternative method is to enable simple server mode on the LOYTEC device. In this mode, the device provides an OpenVPN server and allows downloading a client configuration file from the Web interface. This file can be installed on any OpenVPN client and allows that client connect to the LOYTEC device over the secure VPN channel. Only one client may connect at a time.

Data Point Web UI

The LOYTEC device is now tracking information on the source of a written value for each data point. This information is shown on the data point details Web UI next to the modification timestamp and can be used for troubleshooting, for example, whether a value was modified over the Web UI or is written by a local connection.

Timestamp	2019-03-27 16:21:43+00:00 written by Web UI
State	normal (0x98000000)
Status description	—
Flags	DEFAULT_VALUE OPC

Figure 9: Write source info on the data point Web interface

Make protocol logs more verbose

LOYTEC devices have been improved to decode protocol logs of its supported technologies to be displayed in a more verbose manner. This makes it easier for Modbus, M-Bus, MP-Bus, SMI, DALI, EnOcean to analyze communication problems with other third-party devices. Simply click the Protocol Analyzer link on the statistics Web page of the respective protocol.

EnOcean over L-STAT

L-STAT devices with EnOcean capability can now be used by LOYTEC devices as remote EnOcean antennas like a LENO-800 interface. This EnOcean over Modbus feature expands the air coverage of EnOcean in a multi-room setup. An EnOcean repeater setup that is cumbersome and difficult to troubleshoot is no longer needed. Simply add EnOcean L-STATs to extend the wireless reach of the LOYTEC device.

BACnet for Japan

This software release includes some minor changes to improve BACnet interoperability in Japan. First, a new client mapping mode was added: COV unsolicited + poll. In this mode the client map not only accepts updates via unsolicited broadcast messages but also actively polls the remote devices. Second, any kind of UnconfirmedEventNotification broadcast (event or alarm) can be used to receive value updates. Third, also status flags of client mappings are updated by event/COV notifications that include status flags.

Support Custom Serial Port in JavaScript

A new API has been added that allows using the serial port on a LOYTEC device in JavaScript. This feature can be used to implement custom serial protocols. The port Web interface offers a choice to select such a custom serial implementation based on meta data provided by the JavaScript module. An example for such custom protocol support is DMX, which is distributed as an add-on script resource.

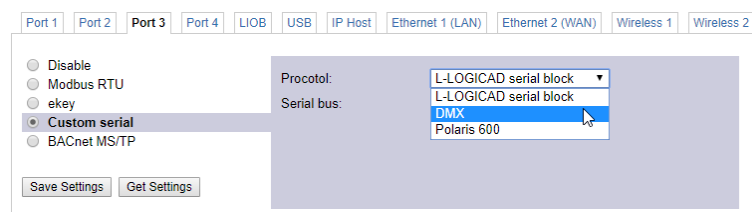

Figure 10: New Web interface to select custom serial protocols.

Other scripting features added to this release are defining debug filter keywords on the Web interface, enabling and disabling scripts, and a new system API to allow firewall ports on the LOYTEC device.

4.3 New in L-INX/L-GATE 6.4.0

This section describes the major changes and new features. For a full list of changes refer to the Readme file.

Localized Web Interface

The entire Web interface of the device has been localized to German, French, and Chinese language. Simply change the language on the LCD display or directly on the Web interface via the new flag symbol on the upper right corner. Changing language is instant and does not require a reboot.

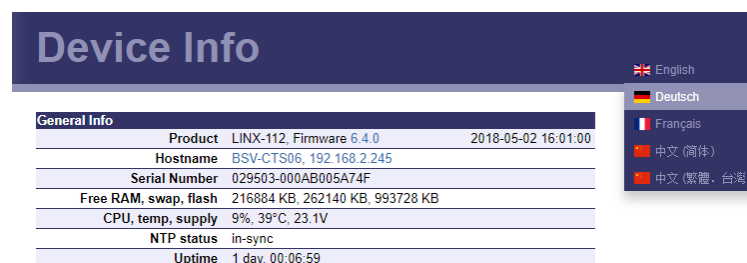

Figure 11: Language selection on the Web interface

Safe Reboot and Auto-Login

Changing IP settings and rebooting could end in a device unreachable, if something was different than expected. The new safe reboot feature helps out by reverting the changes made, if not logged in in on the Web interface within 5 minutes after the reboot. Locking oneself out by entering a mistaken IP address is no longer possible.



Figure 12: Safe reboot screen suggesting new IP address.

Another new feature that helps getting logged in again is the session auto-login. After a device has rebooted the Web interface restores the session and automatically logs in again. Even when changing a static IP address the device tries to connect to the new IP or suggests links for opening the device info page under the new IP address.

Backup before Upgrade

The firmware upgrade feature has been made safer by creating a backup before executing the upgrade. This feature has been added to firmware and Configurator upgrade paths. It is, however, optional and can be turned off by deselecting the check box.

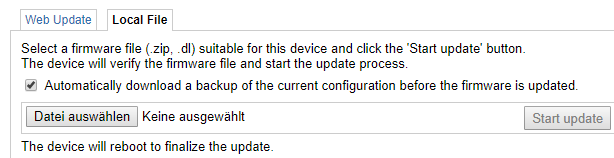

Figure 13: Backup before Upgrade on the Web interface.

Multiple M-Bus Ports

LOYTEC devices with multiple EXT ports now support operating an LMBUS-20/80 interface on each port in parallel. This way the total number of M-Bus devices managed by the LOYTEC device can be increased by using several LMBUS-20/80 interfaces. The commission Web interface supports EXT port assignment and moving M-Bus devices from one EXT port to another.

Binary Interpretation of Analog Inputs

A simple way to turn an analog universal input (UI) into a digital data point has been added. On the UI select the option **Digital Input** and enter an on/off value hysteresis. A binary data point will be created instead of the analog one.

Support Custom Protocols and IoT by Scripting

New models of programmable L-INX and L-GATE devices now include a JavaScript-based scripting engine. This engine allows users to implement their own protocol support for the IoT world using RESTful APIs, JSON or Web services. The LOYTEC data point server allows integrating data points into the scripting language using the dpal-js API. The script modules can be embedded into and deployed along with the data point configuration.

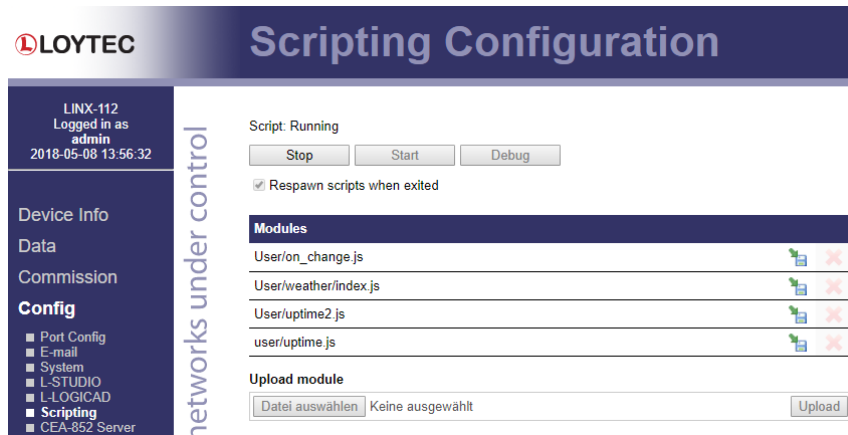

Figure 14: Web interface for scripting engine

The Web interface of the device offers an overview of installed script modules and allows starting scripts in debug mode. Use the Google Chrome inspector to debug JavaScript on the device. For more information read the new Scripting Chapter in the LINX Configurator User Manual [2].

4.4 New in L-INX/L-GATE 6.3.0

This section describes the major changes and new features. For a full list of changes refer to the Readme file.

KNX

The KNX implementation has been reworked. The new version lowers average CPU load and increases performance.

4.5 New in L-INX/L-GATE 6.2.0

This section describes the major changes and new features. For a full list of changes refer to the Readme file.

New Models

The L-INX automation server family has been extended by two new programmable all-rounder models. The new LINX-215 combines the functionality of all LINX-11x, 21x. It provides both router and RNI functionality, which can be configured as needed. The LINX-153 as the larger sibling combines the functionality of the bigger L-INX models LINX-12x, 15x, 22x and also provides a configurable router/RNI. The new LINX-154 model has been designed to accommodate a maximum number of Modbus RTU and/or BACnet MS/TP devices on its four RS-485 ports.

L-STUDIO 3.0 with 61131 Run-Time

New L-INX and L-IOB controller models are now embedded into the L-STUDIO workflow using a 61131 program run-time environment. This new environment combines both advantages, the well-known 61131 programming workflow and the powerful mechanisms of L-STUDIO for mass-engineering LOYTEC controllers. Support for the previously used logicCAD run-time and programming tool is also continued for existing products.

LMPBUS-804

The LMPBUS-804 interface is supported. This is a four-channel MP-Bus interface connected to the USB port of the LOYTEC device. The PPX addressing mode is now also supported for MP-Bus as well as an MP-Bus scan engine. For more information on MP-Bus read the respective Chapters in the Device User Manual [1] and the LINX Configurator User Manual [2].

LCD Interface

The user interface on the LCD display has been extended by a firmware upgrade menu. This menu allows installing a new firmware image from an attached USB memory stick. This is beneficial for WLAN-only devices. When plugging in a USB memory stick, a menu pops up (Figure 15) on the LCD interface that shows selected quick options, including firmware upgrade and backup.

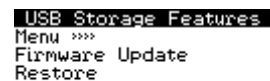

```
USB Storage Features
Menu >>>>
Firmware Update
Restore
```

Figure 15: LCD pop-up menu for USB storage

BACnet Features

A new BACnet client mapping type has been added: The COV unsolicited type. This new read mapping type, a client mapping will accept broadcast COV updates without subscription.

A new type of BACnet favorites has been added, which offer BACnet-related options such as adding BACnet properties. When linking a BACnet favorite to a BACnet server object, the respective BACnet property data points are added and linked to the link target.

L-IOB Firmware Upgrade and V2 Models

The L-IOB firmware upgrade has been enhanced by a parallel upgrade mode. This mode is back-ward compatible to existing L-IOB devices and allows parallel upgrade over the network. This means a number of devices receive the firmware upgrade at the same time which greatly improves upgrade time over LIOB-FT. This also applies to the new V2 L-IOB models. The Configurator firmware upgrade dialog has also been extended to allow the assignment of a universal L-IOB firmware ZIP archive to all L-IOB models.

Web UI

The data point details page on the Web UI provides write usage information. This information can now be used to determine by which objects a certain data point is being written to. The Web UI design has also been reworked according to the latest security standards, now suggesting usage of strong passwords.

4.6 New in L-INX/L-GATE 6.1.0

This section describes the major changes and new features. For a full list of changes refer to the Readme file.

LSMI-804

The LSMI-804 interface is supported. This is a four-channel SMI interface connected to the USB port of the LOYTEC device. It also contains four relays for SMI channel power-on

functionality. This saves energy while the SMI bus is idle. For more information on SMI read the respective Chapters in the Device User Manual [1] and the LINX Configurator User Manual [2].

Selective Backup and Restore

The backup and restore interface on the Web interface has been extended by content options. It is now possible to decide whether a created backup shall contain passwords, IP settings or historical data (trend logs, alarm logs). Also when restoring a backup archive it can be selected whether password and IP settings shall be accepted from the backup or not. This makes it easier to replicate devices without sacrificing the IP configuration and password settings. An example is shown in Figure 16.

The screenshot shows two sections: 'Backup Configuration' and 'Restore Configuration'. The 'Backup Configuration' section has a heading, a description, and three checked checkboxes for including passwords, IP settings, and trend logs in the backup, with a 'Backup' button below. The 'Restore Configuration' section has a heading, a description, a file selection field with 'Datei auswählen' and 'Keine ausgewählt' options, two unchecked checkboxes for restoring passwords and IP configuration, and a 'Restore' button below.

Figure 16: Backup and restore options on the Web UI.

L-STAT Configuration Backup

The Modbus commission Web UI has been extended to better support L-STAT devices. Now it is possible to upload one or more L-STAT backup files and save them on disk. Those L-STAT backup files can also be restored to L-STAT devices. The regular device backup now includes all L-STAT device backups as well.

Advanced WLAN Mesh Configuration

The WLAN Mesh configuration has been enhanced by a graphical floorplan editor as well as an online monitor of inter-link communication quality. This tool allows not only easier setup of a Mesh network but also simple troubleshooting by identifying radio bottleneck between Mesh points (see Figure 17).

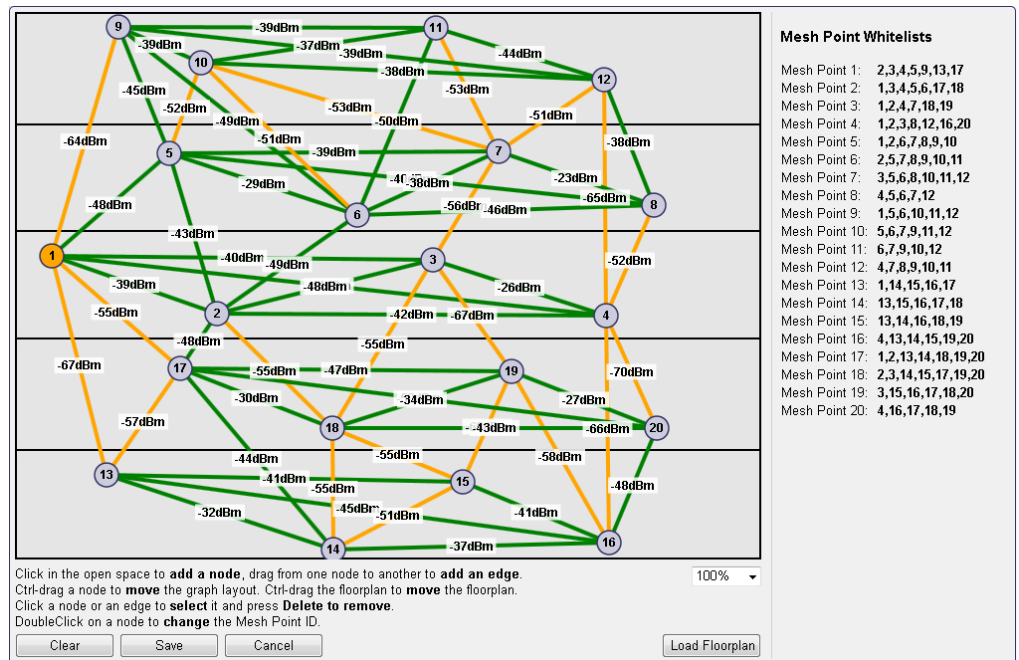

Figure 17: Mesh floorplan and online link quality monitor

Flexible Column Layout in Configurator

The Configurator now supports a flexible column layout in the data point list. It is possible to modify the column arrangement and add/remove columns as needed. This provides for better overview in situations where the default column layout misses important information. The new **Configure Columns** dialog makes this possible.

Incremental Data Point Scan

The data point scanning engine of the Configurator has been extended to mark data points already used on the device and data points found in new scans. The last two columns **Used on Device** and **Last Scan** of Figure 18 show an example and can be used to sort the list. This way the data point configuration can be easily adapted to incremental changes of the scanned devices.

Datapoint Name	No.	Dire...	Remote NV	Type	Remote Device	Func. Block	Used...	Last Scan
← nvo00temp	1	In	nvo00temp	SNVT_temp	tn50	Ctrl	<input checked="" type="checkbox"/>	Already scanned
→ nvi01temp	2	Out	nvi01temp	SNVT_temp	tn50	Ctrl	<input checked="" type="checkbox"/>	Already scanned
← nvo02lux	3	In	nvo02lux	SNVT_lux	tn50	Ctrl	<input checked="" type="checkbox"/>	Already scanned
→ nvi03lux	4	Out	nvi03lux	SNVT_lux	tn50	Ctrl	<input checked="" type="checkbox"/>	Already scanned
← nvo04lev_percent	5	In	nvo04lev_percent	SNVT_lev_percent	tn50	Ctrl	<input checked="" type="checkbox"/>	Already scanned
→ nvi05lev_percent	6	Out	nvi05lev_percent	SNVT_lev_percent	tn50	Ctrl	<input type="checkbox"/>	Already scanned
← nvo06temp_f	7	In	nvo06temp_f	SNVT_temp_f	tn50	Ctrl	<input type="checkbox"/>	Already scanned
→ nvi07temp_f	8	Out	nvi07temp_f	SNVT_temp_f	tn50	Ctrl	<input type="checkbox"/>	Already scanned
▷ ← nvo08switch	9	In	nvo08switch	SNVT_switch	tn50	Ctrl	<input type="checkbox"/>	Already scanned
▷ → nvi09switch	10	Out	nvi09switch	SNVT_switch	tn50	Ctrl	<input type="checkbox"/>	New
← nvo10motor_state	11	In	nvo10motor_state	SNVT_motor_state	tn50	Ctrl	<input type="checkbox"/>	New
→ nvi11motor_state	12	Out	nvi11motor_state	SNVT_motor_state	tn50	Ctrl	<input type="checkbox"/>	New

Figure 18: Example of an incremental data point scan

LCD Interface

The user interface on the LCD display has been localized for the Chinese simplified and traditional language sets. The language can be selected from the main page and is switched immediately without a device reboot.

Another feature on the LCD display is the option to rotate the display 180 degrees. This is a useful setting, if the device is mounted upside down.

EnOcean VLD Profile Support

EnOcean devices that require variable-length data (VLD) profiles are now fully supported. The respective device templates are provided by LOYTEC. In addition to new profiles, the teach-in process on the Web interface has been improved by dialog wizards that guide through bi-directional teach-in and assignment of transmission IDs.

4.7 New in L-INX/L-GATE 6.0.0

This section describes the major changes and new features. For a full list of changes refer to the Readme file.

New User Manual Structure

The L-INX/L-GATE User Manual has been split up into three parts: The L-INX/L-GATE User Manual, which now covers the specific functions of the L-INX and L-GATE device models. The LINX Configurator User Manual is a common description for using the Configurator software for the L-INX, L-GATE, L-ROC, L-IOB, and L-DALI product line. And the LOYTEC Device User Manual covers hardware, Web interface, LCD display and operating interfaces topics common to all LOYTEC devices.

New Models and Combined Firmware

The new LROC-400 room controller models are now supported by the device firmware and in the LINX Configurator. The different device firmware images for LROC-10x, LIOB-AIR, and LROC-400 have been integrated in one image for all L-ROC, L-INX, LIOB-AIR and L-GATE models.

SMI

A new protocol is now supported: SMI for controlling sunblinds over the Standardized Motor Interface. All LOYTEC devices with an EXT port can now be extended by the L-SMI interface and connect to an SMI bus. The LINX Configurator provides SMI device templates, which can be commissioned on the device Web interface. The Web interface supports manual address assignment, scanning for SMI devices and calibration. For more information on SMI read the respective Chapters in the Device User Manual [1] and the LINX Configurator User Manual [2].

Flexible CSV Import/Export

The entire CSV import/export engine of the LINX Configurator has been revisited. Previously special export options with fixed columns for CEA-709, Modbus, etc. have been replaced by a general CSV engine that is able to configure columns for any set of data point properties. Default property sets have been added, which can be modified by the user and saved for later use. The new CSV import/export allows modifying existing data point properties by batch edit in Excel or creating new data points. The property sets can be viewed and modified in a comfortable export editor (see Figure 19). The new engine also integrates CSV data point templates. Learn more about this flexible import/export mechanism in the LINX Configurator User Manual [2].

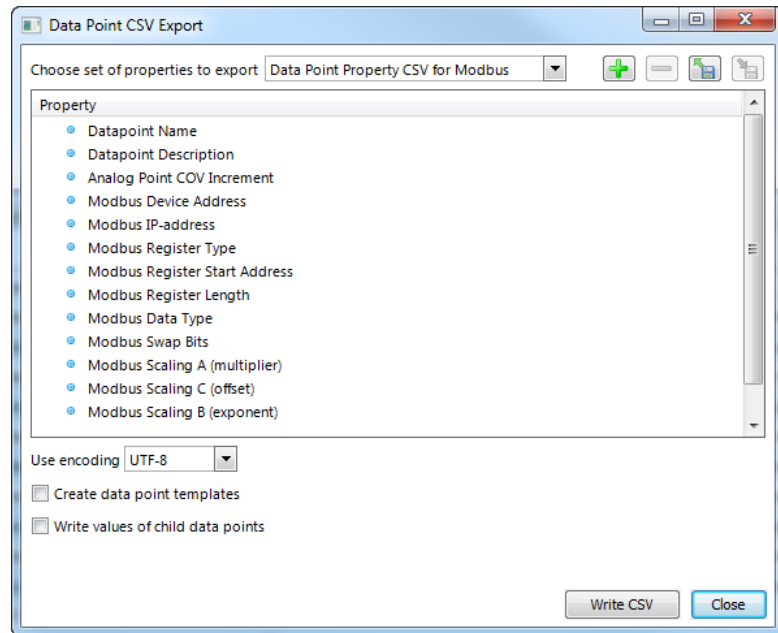

Figure 19: CSV export dialog with configurable columns.

Override Function for Data Points

The data point model in LOYTEC devices has been extended with a manual override function. On the Web interface and on the LCD display data point values can be overridden to manual values. If an override value is set, the running control logic no longer affects the data point value, neither does network communication. The override value is in effect until it is removed again by the user.

Data Point Details	
Path	/User Registers/ValvePos
Name	ValvePos
Description	—
Direction	value
Type	analog
Value	100 % <input type="button" value="Set"/> <input type="button" value="Set override"/> <input type="button" value="Clear override"/>
	<small>Enter "-" for invalid value</small>
Raw value	00 00 00 00 00 00 59 40 <input type="button" value="Set"/> <input type="button" value="Set override"/>
	<small>Enter "-" for invalid value</small>
Timestamp	2016-02-19 14:51:38+00:00
State	overridden (0x88000001)

Figure 20: Overriding a data point on the Web interface.

WLAN Mesh Configuration

The Mesh Point mode has been extended by a whitelist function. This allows configuration of a Mesh network with up to 32 nodes. The whitelist contains all mesh point IDs that may contact each other. In order to make configuration of the mesh network easier, the Quick Wireless Setup has been added, which allows a first mesh setup in only a few steps. For optimizing the whitelist the Web interface offers a graphical editor, which makes changes quick and simple. On device models with an LCD display the wireless setup can also be completed using the jog dial. For more information on how to set up a Mesh network please refer to the respective Sections of the LOYTEC Device User Manual [1].

Alarm Messages

The length of alarm messages has been extended to 250. This increased length comes in combination with a new % {path} variable placeholder that can identify the data point path in alarm messages. This is beneficial for mass-engineering alarm conditions on data points

that have the same name but are located in different path locations. Alarm logs have also been updated to support the new maximum length. BACnet now supports the Event Message Texts property of an alarmed object, which allows retrieving the messages also after a reboot of an alarm client. And analog alarm conditions have been extended to specify a high limit and a low limit alarm message.

Trend Logs

The generic trend logs have been extended to support recording string values. These trends can be operated as polled, COV or triggered. These trend logs can be beneficial to record arbitrary messages. The string recording is currently limited to generic trend logs only.

New E-Mail Placeholders

E-Mail configuration has become even more flexible by adding new variable placeholders. The variable placeholders can be augmented by name, description and path specifiers that expand to the respective information in the e-mail. A new date format specifier allows for readable timestamps and the % {last_timestamp} variable expands to the time the last e-mail was transmitted.

BTL Testplan 12 Certified

The BACnet certification of all BACnet models has been updated to comply with protocol revision 12. All new device models are now BTL certified.

4.8 New in L-INX/L-GATE 5.3.0

This section describes the major changes and new features. For a full list of changes refer to the Readme file.

New L-INX and L-GATE Models

The new L-INX and L-GATE models in the small enclosure are now supported. Equipped with dual Ethernet, a built-in firewall and LCD display, these new models serve as a plug-in replacement for the older devices. Existing data point configurations and device backups can be used without modification. Only logiCAD programs need to be re-compiled for the new hardware resource. In addition, the new models also support L-IOB connect, wireless technologies and KNX.

Extended Support for U.S. Units

An extended support for U.S. units has been built into LOYTEC devices. A device can now be configured to run either in the SI or the U.S. unit system by defining SI and U.S. units per data point as shown in Figure 21. When configured for U.S. units, all data points and L-IOB I/Os process values in the respective U.S. units. This includes the Web UI, the OPC server, the parameter file, global connections, and logiCAD programs. Also the Configurator displays values in U.S. units and conversions are done automatically. A device can even be switched from one unit system to the other. In this case all persistent parameters are reset to their default values in the chosen unit system. A system register shows the currently running unit system. This makes it easy to entirely engineer a device in U.S. units or build devices that can be configured for either European or U.S. markets and meet local requirements at the same time. For more information on units please refer to the LINX Configurator User Manual [2].

Analog Datapoint Max Value [°F]	<input checked="" type="checkbox"/>	100	Max range of the value
Analog Datapoint Min Value [°F]	<input checked="" type="checkbox"/>	32	Min range of the value
Analog Datapoint Precision		0	Number of significant decimals
Analog Datapoint Resolution [°F]		0	Smallest value increment
Analog Point COV Increment [°F]	<input checked="" type="checkbox"/>	5	Change-of-value increment
Unit SI	<input checked="" type="checkbox"/>	°C	Data point unit used in the SI system
Unit U.S. (active)	<input checked="" type="checkbox"/>	°F	Data point unit used in the U.S. system

Figure 21: Configuration of SI and U.S. units on a data point

OPC Client

L-INX and L-GATE devices are extended by their own OPC client technology. Using the OPC client you are able to integrate other LOYTEC devices simply by importing the data point configuration of their OPC servers. This way an L-DALI device can be added to a L-INX configuration in a few steps. The OPC client can also take advantage of the commission later feature by using the Web UI in order to assign OPC server URLs at the time of device commissioning. Even the base path to imported OPC tags can be replaced. This way sub-configurations can be imported to save OPC client tags and be re-assigned later. Learn more about the OPC client function in the LINX Configurator User Manual [2].

Forward Delay in Connections

For applications that require staggered start/stop and randomization, the device implements a configurable forward delay in local and global connections. All receive data point items can be configured with a delay. A received value is written to the data point after the delay expires. The delay can be a fixed time or a time interval, in which the actual delay is randomized. With a resolution of 0.1 seconds the total delay can be up to 100 minutes. Learn more about forward delay in the LINX Configurator User Manual [2].

Auto-Generate and Connect

The auto-connect feature has been extended:

- Support `%{folder_descr}` as a placeholder in auto-generate templates. This evaluates the description property of the parent folder.
- Generate into existing connections. Especially when auto-generating the same source data points to different technologies, the same connections are used. This makes it easier to manage auto-generated local connections.

Enhanced Structure Support on the Web UI

The display of data point structures has been improved on the Web UI. The data point listing shows a textual short version of the structured value instead of a hexadecimal Byte buffer. Also CEA-709 structures of NVs without sub-data points are displayed and can be edited.

Project Documentation

A new feature on the device is a Web UI for creating and viewing project documentation on the device. The documentation editor requires admin rights and allows storing files on the device or creating documentation links as URLs. Both items can be viewed by guest users. Examples include storing cabling plans as PDF or adding links to a Web site containing manuals, plans or other useful project documentation. Consult the LOYTEC Device User Manual [1] to learn more about project documentation on the device.

LWEB-802 Application on Device

The L-INX and L-GATE device now come with a pre-installed version of the LWEB-802 application. This enables out-of-the-box L-WEB applications on sites without Internet access. An enhanced Web UI also allows installing a specific version of the LWEB-802 application, which overrides the pre-installed one. As a default, the Internet version is still

available. To learn more on how to configure the L-WEB application refer to the LOYTEC Device User Manual [1].

BACnet

All previously extended BACnet features and new features have been BTL-certified in the 5.X firmware series. New features include:

- BACnet object names can be made writeable. With this new option the user can create data point configurations with generic object names and assign location-specific names later in his OWS.
- BACnet simple value objects are now supported. The user can create Large Analog Value, Signed Integer Value, Unsigned Integer Value, Character String Value and Octet String Value objects as needed. Also auto-connect supports these new object types.
- For Trend Log objects, the properties Notify_Type, Event_Enable, Notification_Class can be pre-configured in the data point configuration.

User-defined Serial Protocols in logiCAD

A new logiCAD service block has been introduced, which allows implementation of generic serial protocols. The 'SerialComm' service block can receive and transmit strings from and to a serial port using start frame and end frame delimiting characters. A logical bus number is assigned to the service block, which can be selected as a custom serial protocol on the port configuration Web UI as shown in Figure 22. Please read Section 8.6.10 to learn more about using the 'SerialComm' block.

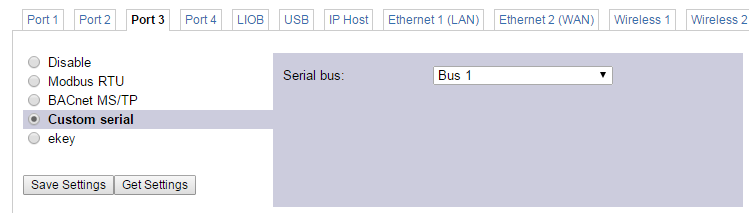

Figure 22: Selecting a custom logiCAD serial protocol.

Data Point Creation from CSV Lists

The Configurator implements a new data point template CSV import feature, which can be used by external tools to generate a list of data points. Each line in this CSV references a data point template file that describes all properties of the data point. The CSV supplies name, description and path of the data point to be created. Additionally, data points can be automatically scheduled and trended. Learn more about data point templates in the LINX Configurator User Manual [2].

KNX Protocol Analyzer

Devices that support the KNX protocol now have a built-in protocol analyzer. It can be accessed through the KNX statistics Web interface and allows starting, stopping and storing protocol logs on any of the KNX interfaces. Protocol logs can be loaded from the device and stored on the PC either in CSV or in XML format. The XML format can be opened in the ETS protocol viewer. Learn more about the KNX protocol analyzer in the KNX Chapter of the LOYTEC Device User Manual [1].

ekey Fingerprint Readers

LOYTEC devices can now be used to build applications with biometric access control (fingerprints). The ekey fingerprint reader devices can be attached to the RS-485 port. Users and fingers can be enrolled and grant or deny access when swiping the finger over a reader. User groups can be implemented and distributed over reader devices. Learn more about ekey fingerprint reader support in the ekey Chapter of the LOYTEC Device User Manual [1].

4.9 New in L-INX/L-GATE 5.1.0

This section describes the major changes and new features. For a full list of changes refer to the Readme file.

Dual-Ethernet with Separate Networks

L-INX and L-GATE models with two Ethernet interfaces can now be configured to work with separate and isolated IP networks. For example, one Ethernet interface can be accessed over HTTPS from a WAN connected to Ethernet 2 while the building network services are running locally on the LAN connected to Ethernet 1. For configuration the device provides separate Ethernet tabs in the port configuration, which allow selecting the offered services on each interface. The example in Figure 23 shows a WAN interface with HTTPS and OPC UA only, while BACnet/IP or CEA-709 over IP are still bound to Ethernet 1 (LAN). Another use case for this feature is operating a gateway between otherwise entirely isolated building networks, e.g. BACnet/IP on Ethernet 1 and KNXnet/IP on Ethernet 2.

The screenshot shows the configuration page for Ethernet 2 (WAN). The interface includes a list of services on the left and configuration fields on the right. The services list includes: Port Mode, TCP/IP (checked), VNC for LCD UI, FTP, Telnet, SSH, Global Connections (CEA-852), CEA-709 over IP (CEA-852), Web UI, HTTP, HTTPS (checked), Modbus TCP, KNXnet/IP, Remote packet capture, BACnet/IP, RNI 0 (CEA-709), SNMP, OPC XML-DA, and OPC UA (checked). The configuration fields on the right include: Use DHCP (checked), IP Address, IP Netmask, IP Gateway, DNS Server 1 (10.101.17.2), DNS Server 2, DNS Server 3, NTP Server 1 (0.pool.ntp.org), NTP Server 2 (1.pool.ntp.org), NTP Status (in-sync), and MAC Address (02:0A:B0:02:7C:39) with a checked 'Use Factory Default' option. A note at the bottom states: 'The entries marked with (*) are required for proper operation'.

Figure 23: New Ethernet 2 (WAN) tab

WLAN Interface

In combination with the external LWLAN-800 interface, the device provides new interface tabs for wireless IP networks. Similar to the second Ethernet interface, one can choose which protocols are available on the wireless network. The wireless interface can be configured as a WLAN client, access point or mesh node. Using the latter, a wireless mesh network of LOYTEC devices can be built. Please refer to the LOYTEC Device User Manual [1] to learn more about the WLAN interface.

EnOcean

The EnOcean technology is now supported by the L-INX and L-GATE devices. Together with the external LENO-800 interface, EnOcean sensors and actuators can be easily integrated. LENO-800 interfaces are available for European, U.S. and Japanese frequency

bands. Data point configurations for the EnOcean technology are built using EnOcean device templates. The actual assignment of physical devices is done later in the teach-in process over the Web UI. For more information on the EnOcean technology please refer to EnOcean Chapter of the LOYTEC Device User Manual [1].

SNMP

For accessing vital operational data in standard IT equipment, L-INX and L-GATE devices offer an SNMP management base (MIB). All system registers and OPC-exposed data points are available in that MIB. The MIB file can be downloaded from the device and imported in the SNMP management tool. Alarms on the device can be exposed as SNMP traps. For more information on configuring and using SNMP with a LOYTEC device please refer to the LOYTEC Device User Manual [1].

Online Commissioning

The Web interface of the device now provides an online commissioning tool for the respective networking technologies. Using this tool, data point configurations can be created based on placeholder devices, which are marked to be commissioned later. The necessary addressing information can be assigned later on the Web interface by scanning for devices online or be entered manually. Device replacement is also possible in the commissioning Web interface without the need to edit devices in the data point configuration. For more information on the commissioning Web UI please refer to the LOYTEC Device User Manual [1].

Favorites

Enhancements for using favorites include engineering units, active/inactive texts, multi-state texts and value persistency for unlinked favorites. A new feature are structured favorites. For example, the structure of a SNVT_switch may now be created as a favorite. The top-level part of a structured favorite can be linked to a structured data point of the same type. Alternatively, the individual member elements of a structured favorite can be linked to other, individual data points. This way, one is able to create a structured favorite, that can be linked directly to a matching SNVT or to separate BACnet objects..

Web Interface

The Web interface of the device offers a number of new features:

- A new device info page provides a quick overview of all relevant operational parameters, such as CPU load, active protocols, time synchronization and many more.
- The trend log configuration on the Web UI now also provides a preview tab, which shows a chart of the trend log data. The trend chart allows zoom, scrolling and hiding specific data curves, as shown in Figure 24.



Figure 24: New trend chart on the Web UI

Scheduler

The scheduler objects have been extended by the following new features:

- Color support in BACnet and generic schedulers allows consistent assignment and display of preset colors in L-WEB, L-VIS and the Configurator scheduler UIs.
- Event auto-prune removes passed events, if the capacity of exception events in a scheduler gets low.
- The scheduler default for LONMARK and generic schedulers is extended by a “silent” mode. In this mode the scheduler becomes inactive as soon as the last event is withdrawn. This mode can be used in event-driven scheduler models.
- Generic schedulers allow specifying an existing value preset as the schedule default. LONMARK and BACnet schedulers try identifying a matching preset name from the schedule default value.

5000 BACnet Client Maps and Dynamic Polling

The number of BACnet client mappings on the L-INX has been increased to 5000. This has become possible with the use of strict on-demand dynamic polling on the device. This means any data point configured for polling (client mappings, external NVs, Modbus, etc.) will start polling only when it is actually used, i.e. displayed on L-WEB, the data point Web interface or used by a trend log. This reduces the required network bandwidth.

1000 Trended Data Points in LINX-12x/15x/22x/LGATE-95x

The bigger L-INX and L-GATE devices now allow a total of 1000 trended data points distributed among the 512 trend logs. This limit can be exploited when trending two or more data points in a generic trend log.

Alarm Server Ack-All Data Point

Alarm servers now provide a special ackAll property data point. When writing TRUE on that data point all currently active alarms on the alarm server are acknowledged.

Format Strings in E-Mails

Data point variables used in e-mail templates can now use format strings to specify their numeric appearance in the e-mail text.

Output NVs with Integrated Feedback

Output network variables (NVs) are used to send updates to remote nodes. In order to poll back the actual value of the remote variable, a feedback data point had to be created for the output NV. Now changing the direction on the NV from output to value, an integrated feedback function is activated without the need for an extra data point. This becomes especially useful in data point templates.

Modbus and M-Bus Templates

Modbus and M-Bus device templates offer some new features that boost productivity:

- Templates can now contain definitions of pollgroups and other type resources used by Modbus data points.
- Templates can now store a folder hierarchy.

4.10 New in L-INX/L-GATE 5.0.0

This section describes the major changes and new features. For a full list of changes refer to the Readme file.

Generic Scheduler

Generic schedulers – like generic trends and alarms – can now be created, that are neither CEA-709 nor BACnet objects. Generic schedulers appear next to the generic alarm folder and are ready-to-use on any device. This is beneficial for creating technology-independent applications. Generic schedulers can write to any technology as well as data point favorites and are the ideal solution, if configured via LWEB-900 only. For more information on creating generic schedulers refer to the LINX Configurator User Manual [2].

Optimum Start for Schedulers

Up to now, optimum start was limited to using a SNVT_tod_event in a CEA-709 scheduler. Now all schedulers (including BACnet and generic schedulers) support timeToNext and nextState data points for implementing optimum start algorithms also for those technologies. Schedulers are extended by property relations, which offer the time to the next state in minutes and the next state in data points. Also, the enable, enableFb (feedback), and presetName information is available as property relations.

The BACnet scheduler object also has custom properties that expose time to next state and next state to BACnet. If standard BACnet objects are required, the property relations can be linked to any matching BACnet server object as shown in Figure 25 (BV_nextState, AV_timeToNext).

LINX-200 ▶ BACnet Port ▶ Scheduler

Scheduler Name	No.	Direction	OPC	Direction
Schedule_BO_occupied	1	Value	<input checked="" type="checkbox"/>	Value
enable	1.1	Value	<input checked="" type="checkbox"/>	Value
enableFb	1.2	In	<input checked="" type="checkbox"/>	In
nextPresetName	1.3	In	<input checked="" type="checkbox"/>	In
nextState -> BACnet Port.Datapoints.BV_nextState	1.4	In	<input checked="" type="checkbox"/>	In
presetName	1.5	In	<input checked="" type="checkbox"/>	In
timeToNext -> BACnet Port.Datapoints.AV_timeToNext	1.6	In	<input checked="" type="checkbox"/>	In
BACnet Port.Datapoints.BO_occupied	1.7			

Figure 25: BACnet scheduler with next state data points.

Favorites

Favorites have been vastly extended to be compatible with all uses that were previously only possible for regular data points. Favorites can now be trended, can have an alarm condition (reporting to a generic alarm server), and be scheduled. Historic filters can be applied to favorites. Favorites can also be used in e-mail templates, math objects and connections like any other data point. Furthermore, it is possible to link favorites to property relations and vice versa, e.g. link a favorite directly to a historic filter data point.

Historic Filters

Historic filters have been extended by a generic delta calculation between any of the defined filter items or the current value. This way, it is no longer necessary to create a separate math object to calculate the consumption of the previous month. Also, a definition for “last day of month” has been added to the monthly period.

256 Trend Logs on LINX-10x/11x/20x/21x/LGATE-900

The smaller L-INX and L-GATE devices are now extended from 100 trend logs to 256 trend logs at a total of 256 trended data points. This is beneficial for native BACnet trend logs, which allow only one data point per trend log object. The increase comes at the cost of available log rate, which is reduced from 121,050 to 60,525 records per hour, once more than 100 trend log objects are created. This is, however, still sufficient for 256 energy trends at 1 minute log interval each.

Web Interface

The Web interface of the device offers a number of new features:

- Live update of values in the data point list. This allows monitoring values without repeated pressing of reload. Data point structures can be expanded or collapsed for better overview.
- Breadcrumb navigation has been added to the data point list. This gives faster access to sub-folders.
- A new firmware upgrade menu on the Web interface allows online checking for firmware updates and upgrading by selecting a local firmware file. All this is possible without starting the Configurator.
- The trend overview page displays current trend log states and provides controls for easy trend data upload in CSV format.

Data Point Polling

The receive timeout on input and value data points has been generalized. A receive timeout can now be defined on all technologies for input and value data points. Writing updates to those data points from any source (e.g. a global connection) resets the receive timeout.

Background polling can be enabled in the project settings, which allows a slow polling of all data points even if no pollcycle or dynamic polling has been activated on those data points..

OPC UA Server

The OPC server on the devices, which support security, has been extended by an OPC UA server. This supports the OPC UA binary protocol and exposes the same OPC tags as the well-known OPC XML-DA server. In addition OPC UA offers superior security features as well as slimmer data transfers. For more information on the OPC UA server please refer to the LOYTEC Device User Manual [1].

BACnet

All previously extended BACnet features and new features have been BTL-certified in the 5.X firmware series. New features include:

- Intrinsic alarming for the Accumulator object.
- Option to keep OWS settings in BACnet properties also after a new configuration has been downloaded.
- BACnet naming rules can now freely define how data point names are constructed out of scanned BACnet information.

Conversion to Value Data Points

Firmware versions since 4.9.0 support value data points. The default behavior of the Configurator can be controlled in the project settings. This defines whether new value data points or the old “_Read/_Write” data point combinations shall be created. When using templates in L-WEB or L-VIS it is often an all-or-nothing approach, a mixture is not practical.

For making the transition in old projects to value data points, the Configurator now offers a conversion tool. Multi-select old read/write data points and choose the item **Convert to value** from the data point context menu. This converts the selected data points to the new value data points, leaving the IDs, default values and data point usages intact.

Application Objects

Application objects such as math objects, e-mail templates, and alarm logs can now be organized in folders. Copy and paste of application objects between Configurators has been improved. Math objects now allow single constants and single variable assignments, such as “=5” or “=v1”. Input variables can be configured to trigger a new calculation or not.

Configurator Usability

The folder tree of the data point manager has been brought to state-of-the-art user concepts such as multi-select, drag-and-drop of folders, moving folders, deleting multiple folders and their contents. A name filter can be applied to quickly find folders in the folder tree.

The property tab has been extended by a property name filter. This makes it easy to find the desired property by typing a sub-string of its name in the filter. For a detailed description on the data point properties refer to the LINX Configurator User Manual [2].

Data point link navigation has been made easy by using a **Go to data point** context menu and speed button everywhere data point references are displayed. A data point usage report dialog shows all references to the selected data point and allows jumping to selected objects.

The new **PLC conflicts** tab shows all PLC write conflicts with other write usage of data points such as math objects, connection receivers, etc., while editing the project. This allows

finding problems prior to the configuration download. The conflicts tab also provides easy navigation to data points listed as problematic. For more information refer to Section 8.4.7.

Modbus and M-Bus Templates

Modbus and M-Bus device templates offer some new features that boost productivity:

- Allow setting the device name when storing the template in a file.
- Naming rules for created data points when used on device.
- Configure naming rules for the automatic naming of Modbus devices (e.g. with or without device address).
- Templates include all OPC and PLC settings.
- Imported device templates are also stored in the device configuration. They are now also available after loading a configuration out of the device, not only from the disk file.

5 Quick-Start Guide

This chapter shows step-by-step instructions on how to configure the L-INX for a simple OPC server application with a logiCAD program and using basic I/Os in L-IOB modules. For the L-GATE it gives an example of how to quickly map CEA-709 network variables to BACnet objects in the gateway.

5.1 Hardware Installation

Connect power (12-35 VDC or 12-24 VAC), the CEA-709 and/or MS/TP network, and the Ethernet cable to the ports, which are labeled respectively, as shown in Figure 26. More detailed instructions are shown in Chapter 6.

Important: *Do not connect terminal PWR Supply + with Earth-ground!*

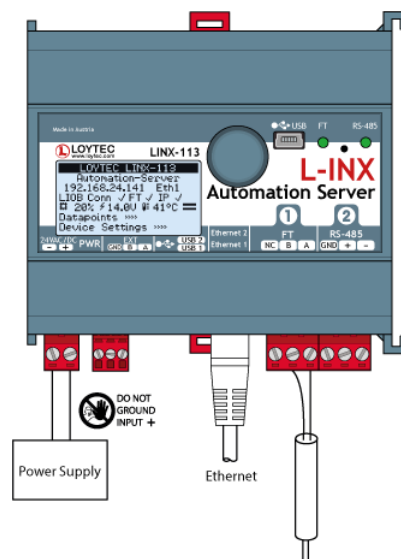

Figure 26: Basic Hardware Installation.

If the L-INX device is connected to a BACnet MS/TP network, the MS/TP network segment must be properly terminated with an LT-04 network terminator connected at each of the two ends of the segment media.

5.2 Configuration of the Device

The device can be configured via LCD display or via the Web interface. To configure the device, the following steps have to be performed:

1. Setup IP configuration (see Sections 5.2.1 and 5.2.2).
2. Setup basic BACnet configuration (see Section 5.2.3).

3. Setup the OPC configuration (see Section 5.3).

Note: This setup procedure assumes the use of the IP interface.

5.2.1 IP Configuration via the Web Interface

LOYTEC devices are shipped with DHCP and will acquire an IP address as soon as they are connected to the network. To use a static IP you can use the Web interface to configure the client device. In a Web browser enter the IP address of the device which can be read on the LCD display. Note that your PC must be attached to the same subnet as the device. For devices with a default IP address choose the setup on the LCD display.

To Configure a Static IP

1. Open your Web browser and type in the IP address shown on the LCD display.

The screenshot shows the 'Device Info' page of the LOYTEC web interface. The left sidebar contains a menu with options: Device Info, Data, Commission, Config, Statistics, L-WEB, L-IOB, e4 project, Reset, Contact, and Logout. The main content area is titled 'Device Info' and is divided into two sections: 'General Info' and 'Device Status'.

General Info			
Product	LINX-151, firmware 5.1.0	2014-12-29 10:02:54	
Hostname	LINX151-OG3, 192.168.24.150		
Serial number	018003-8000000FE038		
Free RAM, swap, flash	18768 KB, 63764 KB, 126780 KB		
CPU, temp, supply	48%, 39°C, 24V		
NTP status	in-sync		
Uptime	7 days, 07:10:16		

Device Status			
OK			
L-IOB status	<input checked="" type="checkbox"/> LIOB <input checked="" type="checkbox"/> LIOB-FT <input checked="" type="checkbox"/> LIOB-IP		
IEC61131 status	<input checked="" type="checkbox"/> Logic running <input checked="" type="checkbox"/> I/O driver active		
IEC61131 program source	C:\Workspace\logicad_prj\LCampus		
Port 1	<input checked="" type="checkbox"/> CEA-709		
Port 2	<input checked="" type="checkbox"/> LIOB-FT		
Port 3	Disabled		
Port 4	Disabled		
LIOB	<input checked="" type="checkbox"/> LIOB-Connect		
USB	Disabled		
Ethernet 1 (LAN)	<input checked="" type="checkbox"/> connected	192.168.24.150	

Figure 27: Example Start Screen.

2. Click on **Config** in the left menu. You will be asked to enter passwords for the administrator and operator accounts before proceeding.

The screenshot shows the 'Config Passwords' page of the LOYTEC web interface. The left sidebar contains a menu with options: Device Info, Data, Commission, Config, Statistics, L-WEB, L-IOB, and Documentation. The main content area is titled 'Config Passwords' and contains the following text:

Enter the desired passwords for the administrator and operator accounts.
The administrator has full access to the device. The operator is able to read and manipulate sensible information such as data points.

Account:
 Password: Password strength: Strong
 Retype password:

Account:
 Password:
 Retype password:

Figure 28: Enter passwords for admin and operator accounts.

3. The Config menu opens. Click on **Port Config** and change to the tab **Ethernet**. The TCP/IP settings are selected as shown in Figure 29. Enter the IP address, the IP netmask, and IP gateway for this device.

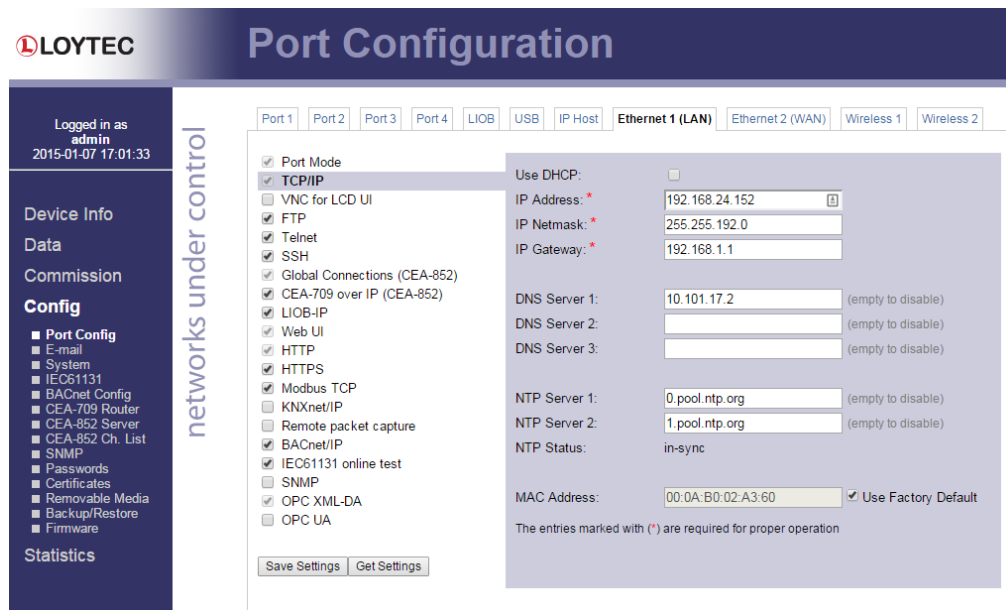



Figure 29: Enter IP address and gateway.

4. Press **Save Settings** and then reset the device by selecting **Reset** in the highlighted text. This changes the IP settings of the device.

5.2.2 IP Configuration via the LCD Display

Device models with an LCD display can also be configured to their basic settings through jog dial navigation on the LCD UI. Turn the jog dial to navigate between menu items and press to enter a menu or go into selection mode. When in selection mode turn the jog dial to alter the value and press again to quit the selection. Some input fields provide acceleration. This means turning faster changes the value in larger increments.

To Set the IP Address on the LCD Display

1. On the LCD main screen set the desired language. Navigate to the language icon , press the button and choose the desired language.
2. Navigate to the IP address on the main screen and press the button.

```
LOYTEC LINX-112
LINX-112-000AB004CF9E
192.168.24.152 Eth1
LIOB Conn ✓ FT ✓ IP ✓
# 11% 23V 39°C
```

3. There navigate to the needed input fields, press and change the value. Press again to set the value. Continue to the next field.

```
TCP/IP Setup
DHCP: OFF
Addr: 192.168.024.150
Mask: 255.255.192.000
Gtwy: 192.168.001.001
Save and reboot
```

4. Finally navigate to **Save and reboot** and press.
5. Acknowledge the reboot and the device reboots with the new IP address.

5.2.3 BACnet Configuration

To configure the BACnet interface, at least the Device ID and the Device Name must be configured (see Figure 30).

Figure 30: BACnet Device Configuration.

The device ID corresponds to the instance number of the BACnet device object. It must be a unique ID on the BACnet internetwork. Also the Device Name must be a unique name on the BACnet internetwork.

By default the BACnet/IP data link layer is used. If the device shall be used with the BACnet MS/TP data link layer, please refer to the LOYTEC Device User Manual [1] for further information.

On devices with an LCD display, the BACnet device ID can also be configured over the LCD UI.

To Configure the BACnet Device ID over the LCD Display

1. On the LCD main screen navigate to **Device Settings** »».
2. Then navigate to the menu **BACnet** »».
3. In that menu navigate to the **ID** input for entering the device ID. The field is split into two controls, one for the thousands and one for singles, to simplify entering big numbers.

```

BACnet
Send I-Am message
ID 0224 150
Name: LINK-151-ST5
BAC/IP net: 1
MS/TP net: 2
Save and reboot

```

4. After the device ID has been entered the device name is automatically assembled using that device ID, if no other name has been configured on the Web UI.
5. On a BACnet router navigate to the **BAC/IP Net** menu item and enter the BACnet network ID of the BACnet/IP network. Then choose the appropriate **MS/TP Net** number for each available MS/TP port. To disable the router port, scroll down till **off** appears.
6. To let the changes take effect, the device needs to be rebooted. For doing this now you may select the menu item **Save and reboot**.

5.2.4 License Activation

On the L-INX devices certain features must be activated by entering a license PIN code on the Web interface or the LCD UI. This license PIN code is entered only once and remains on the device for its lifetime.

To Activate a License on the Web UI

1. Go to the menu **Config** → **System** and scroll down to the **License Activation** section.
2. Enter the 12-digit license PIN code and click on **Activate PIN**.

License Activation

PIN

3. The list of activated features now lists the PIN code and activated license.
4. Finally, reboot the device to start the activated feature.

5.3 Getting Started with the L-INX Configurator

Before setting up a gateway, a working IEC61131 program or creating an L-WEB visualization, the data points of the L-INX automation server or the L-GATE need to be set up. These can be data points of L-IOB I/Os, network variables, BACnet objects, and other available technologies. Before executing the steps below, install the L-INX Configurator Software from the 'setup.exe'. This file can be downloaded from www.loytec.com.

To Start a Configurator Project

1. Start the L-INX Configurator software by selecting Windows **Start** → **Programs** → **LOYTEC LINX Configurator** → **LOYTEC LINX Configurator**. The application starts up and displays the data point manager screen as shown in Figure 31.
2. When the device is online, connect to the device by clicking on the **Connect to device** speed button as indicated by the red rectangle in Figure 31.

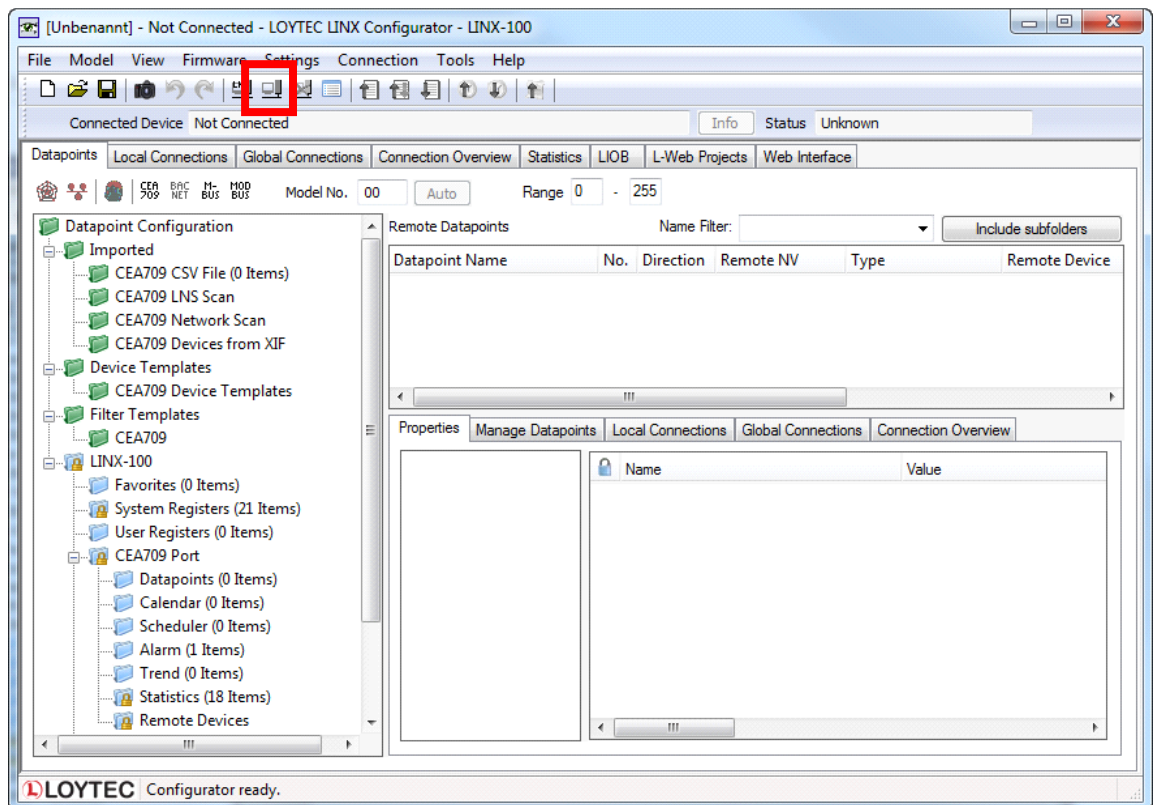



Figure 31: L-INX Configurator main screen.

- For detailed information on how to create data points out of the network please refer to the LINX Configurator User Manual [2].

5.4 Getting Started with the Gateway

The L-GATE and L-INX devices can be used as a gateway between any of the supported network technologies. This example gets you started with the gateway and shows how to map CEA-709 network variables from an LNS database to BACnet. The installer of the L-INX Configurator has already registered the L-INX Configurator as an LNS plug-in. This quick-start assumes LonMaker TE as the LNS tool.

To Configure a Gateway

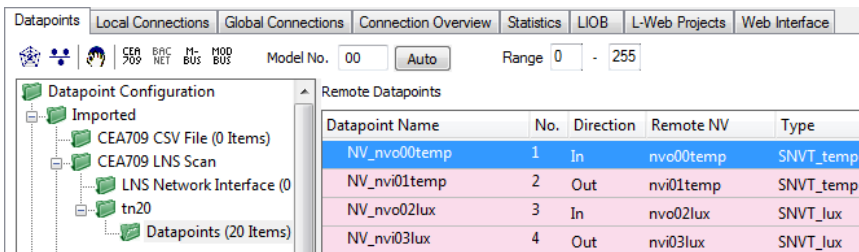

- Open a new LNS database or open an existing LNS database. In the latter case you need to register the L-INX Configurator as an LNS plug-in in that database.
- Add your LONMARK devices to the LNS database.
- Add a new device using the device template for the L-GATE (e.g. 'LOYTEC LGATE-950 FT-10') or L-INX (e.g. 'LOYTEC LINX-150 FT-10') and commission the device.
- Right-click on the added device template and select **Configure ...** This opens the L-INX Configurator as an LNS plug-in.
- Click on the **Datapoints** tab of the main window.
- Click on the button  **Scan channel**. This scans in all NVs on all devices connected to the CEA-709 channel of the device.

- After the scan has completed, the folder **LNS Database Scan** is populated with the found NVs as shown in Figure 32.



Datapoint Name	No.	Direction	Remote NV	Type
NV_nvo00temp	1	In	nvo00temp	SNVT_temp
NV_nvi01temp	2	Out	nvi01temp	SNVT_temp
NV_nvo02lux	3	In	nvo02lux	SNVT_lux
NV_nvi03lux	4	Out	nvi03lux	SNVT_lux

Figure 32: Result of an NV scan in LNS.

- Select the scanned NVs for use in the gateway and click on the button  **Use on Device** in the tool bar.
- The data points are created as dynamic NVs under the **Datapoints** folder of the **CEA-709 Port** folder.
- Select the NVs under the port folder, which shall be mapped to BACnet. Click on the speed button  **Generate and connect selected** in the tool bar.
- The generated BACnet objects appear in the **Datapoints** folder under the **BACnet Port** folder as shown in Figure 32. These objects are also automatically connected to the respective NVs.

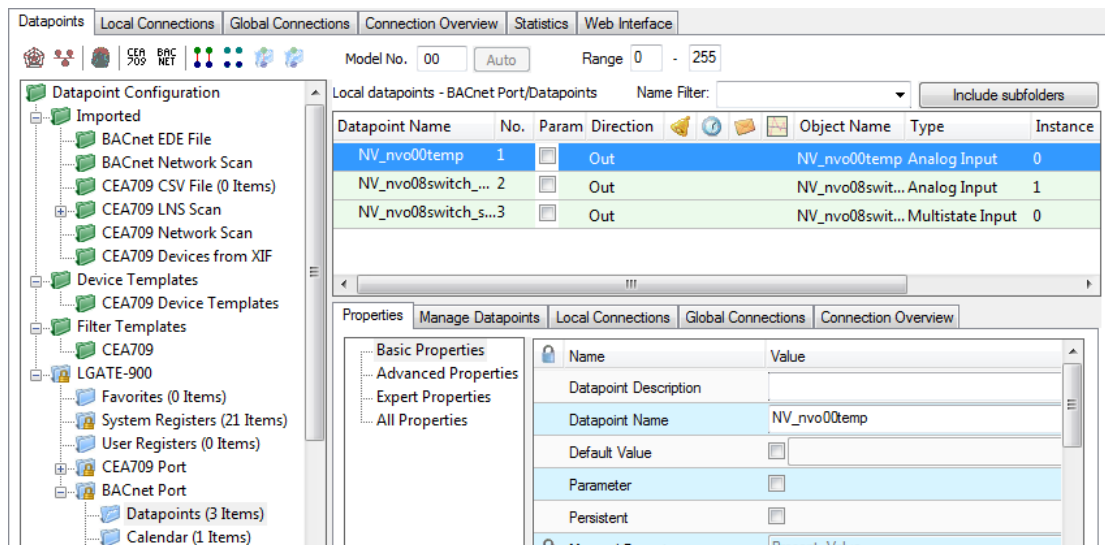

Datapoint Name	No.	Param	Direction	Object Name	Type	Instance
NV_nvo00temp	1		Out	NV_nvo00temp	Analog Input	0
NV_nvo08switch_...	2		Out	NV_nvo08swit... Analog Input	Analog Input	1
NV_nvo08switch_s...	3		Out	NV_nvo08swit... Multistate Input	Multistate Input	0

Name	Value
Datapoint Description	
Datapoint Name	NV_nvo00temp
Default Value	
Parameter	
Persistent	
Present Value	

Figure 33: Auto-created BACnet Points in the BACnet Folder

- Then download the configuration into the device by clicking the **Download Configuration** speed button.



- After the reboot of the device value changes in the NVs are propagated to the connected BACnet objects and vice versa.

5.5 Configuration of the L-IOB I/O Modules

The L-IOB I/O modules can be attached either directly to the LIOB Connect bus or to the LIOB-FT bus with standard TP/FT-10 wiring rules. Please visit the L-IOB User Manual [7] for detailed hardware installation and terminal configuration instructions.

The L-INX Configurator uses a separate tab to configure the L-IOB devices. The L-IOB device configuration can be done off-line and is shown in the following steps.

To Configure L-IOB I/Os

1. Add L-IOB devices on the **LIOB** tab from the supplied L-IOB templates using the **Add Device(s)** button as shown in Figure 34.

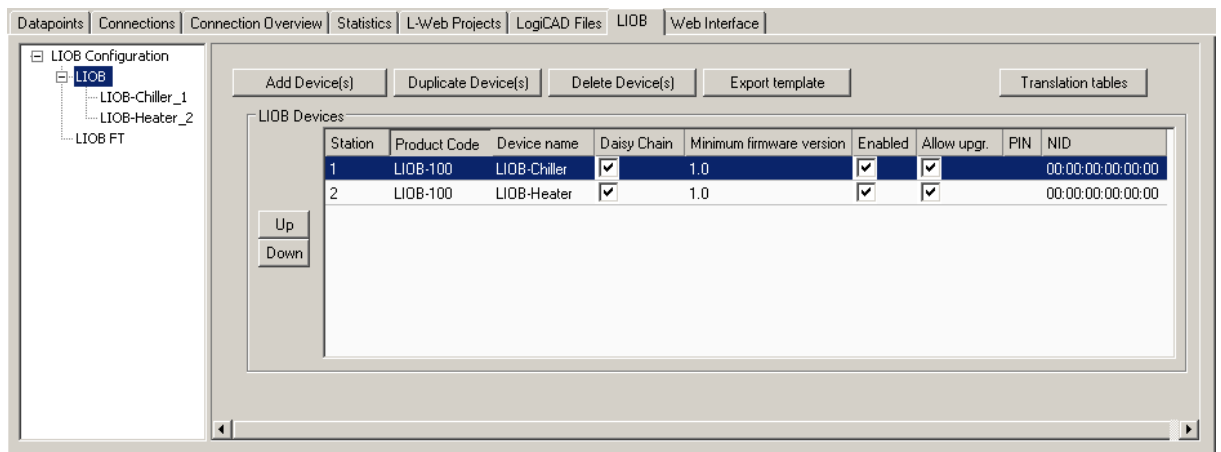

Figure 34: Add L-IOB devices to the LIOB Connect bus.

2. Select a L-IOB device in the tree on the left-hand side and enter names for the terminals by double-clicking into the **Name** column as shown in Figure 35.

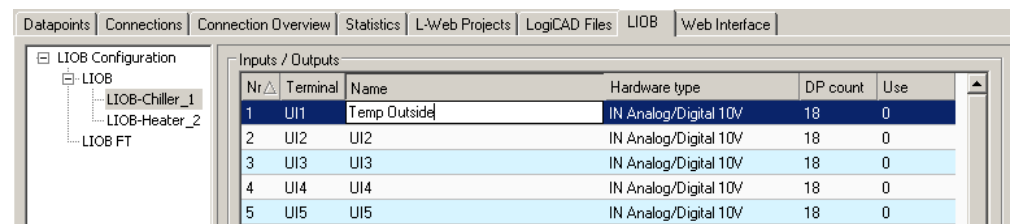

Figure 35: Change L-IOB terminal names for your installation.

3. Select a terminal and change the object parameters to configure this terminal. You can multi-select terminals and change the parameters for all selected terminals.

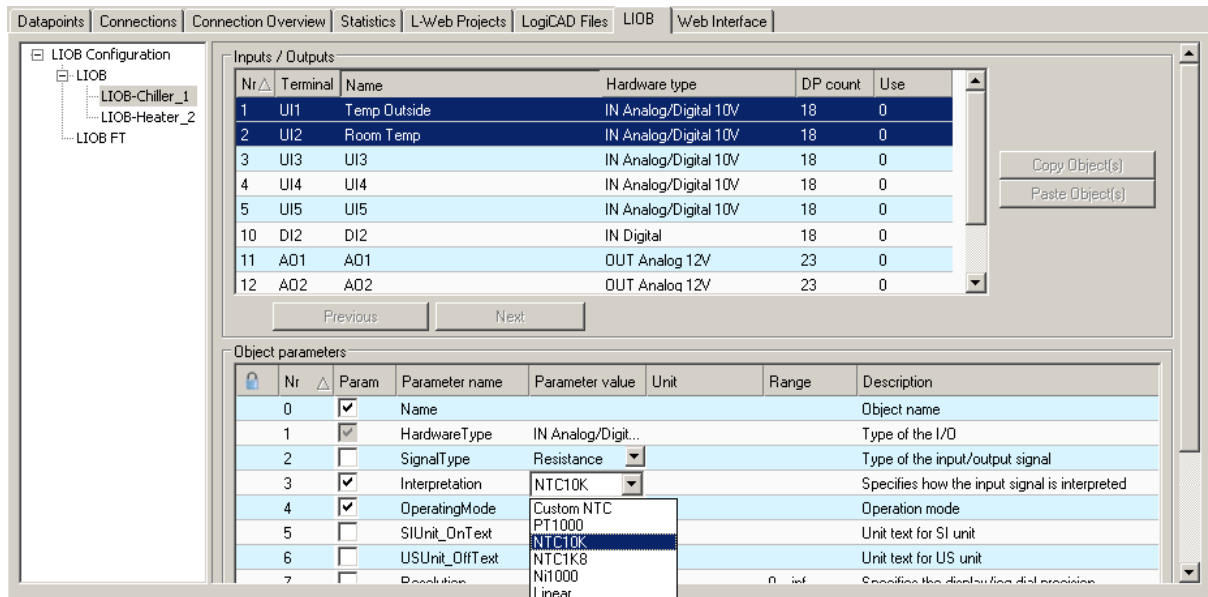

Figure 36: Change L-IOB parameters for the selected terminal(s).

- On the **Datapoints** tab the data points for the LIOB terminals have been created. These data points can be used, e.g., in the logiCAD IEC61131 program. For terminal inputs the data point L1_x_UIy_ **Input_Read** will be used to read an input terminal and for terminal outputs the data point L1_x_DOy_ **Output_Write** will be used to set an output terminal.
- After downloading the L-INX configuration into the L-INX device, the L-IOB input and output terminals can be tested with the L-INX Web UI. An example is shown in Figure 37.



Figure 37: Test L-IOB inputs and outputs on the Web UI.

5.6 Getting started with logiCAD

For developing IEC61131 programs with logiCAD the following components must be installed:

- L-logiCAD setup package. This package installs the logiCAD software, which is needed to design PLC programs for the L-INX device.

2. L-INX Configurator. This software is required to configure the L-INX device to provide the necessary data points to the PLC and integrate the device into the network.
3. logiCAD license for using logiCAD on the PC. The license is available as a softlock version or as a hardlock version with a USB dongle. On virtual machines it is mandatory to use the hardlock license.

A detailed guide on how to install the software components described above and upgrade of an older license can be found in Section 8.2.

To Start a logiCAD Project

1. After installing the necessary software components start logiCAD from the L-INX Configurator by clicking the **Start LogiCAD** speed button.



2. The project wizard starts automatically as shown in Figure 38.

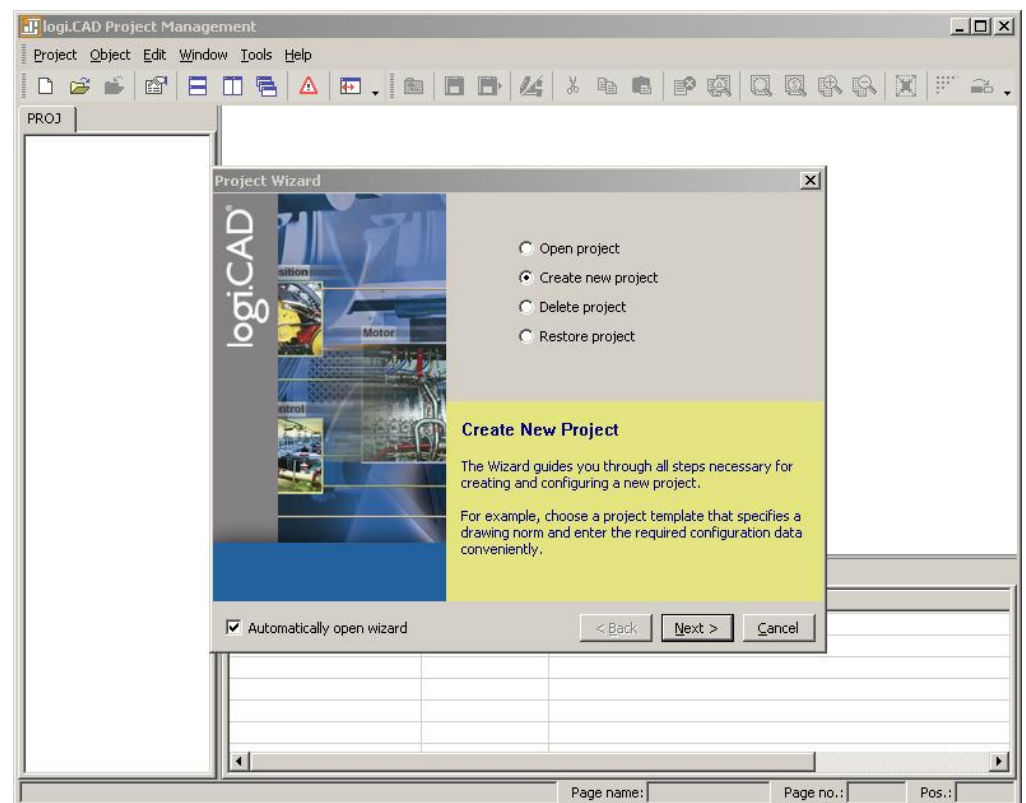

Figure 38: logiCAD project wizard

3. Select Create new project and press **Next**.

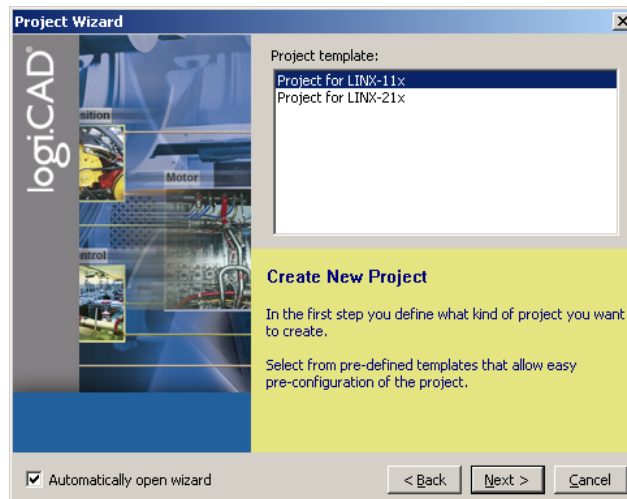

Figure 39: Available project templates

4. Select the project template for the L-INX device (e.g., LINX-11x or LINX-12x).

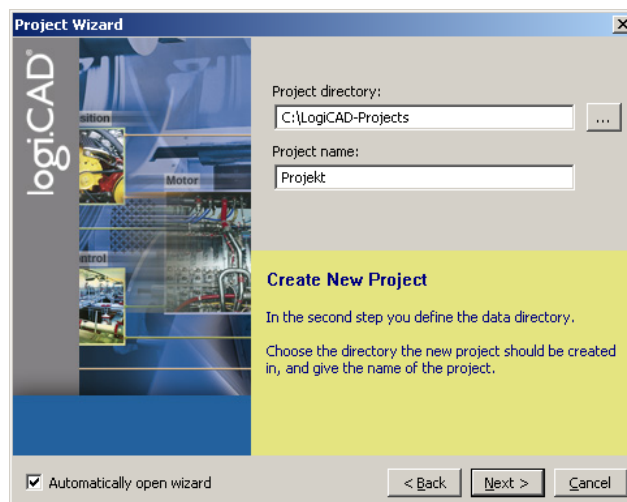

Figure 40: Project name and path

5. Specify the name of the project and the path where to store the project files, see Figure 40.

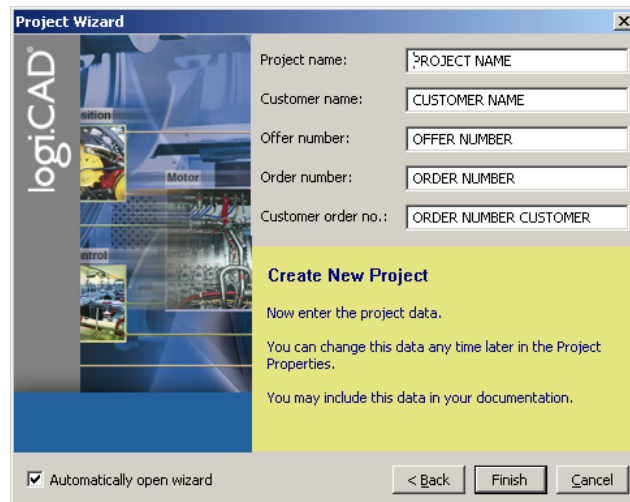

Figure 41: Additional information

6. After specifying additional information the new project is created by pressing the **Finish** button.
7. As shown in Figure 42 below, expand the tree element **Functionplans** and double click **Plan_1** in order to start editing the plan.

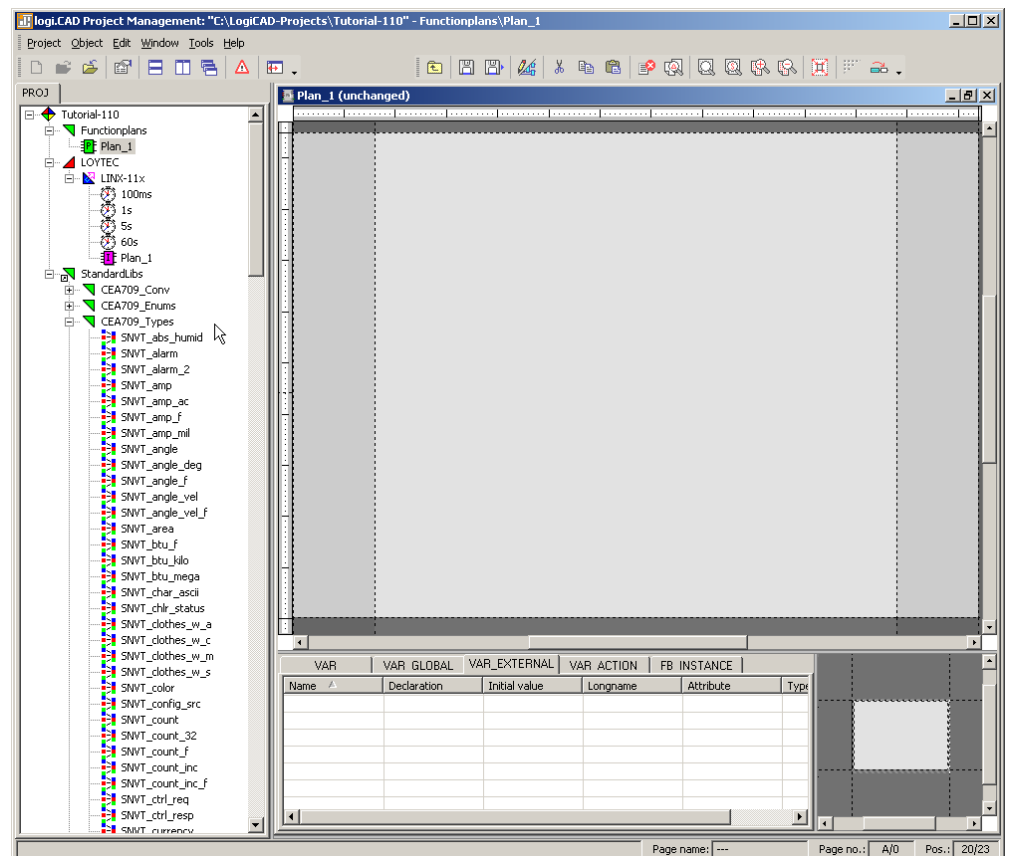

Figure 42: Edit Plan_1

8. In the new LogiCAD project there are no external variables yet. To expose data points from the L-INX to the logic program, activate the **PLC** check box of the corresponding data points in the Configurator, e.g., the L-IOB I/Os of the universal input or any other

data point such as a network variable, user register or BACnet object.

Datapoint Name	No.	OPC	PLC	Direction	Register Name
L1_1_UI2_Input_Read	1	<input checked="" type="checkbox"/>	<input checked="" type="checkbox"/>	In	L1_1_UI2_Input
L1_1_UI2_IOStatus_Read	2	<input type="checkbox"/>	<input checked="" type="checkbox"/>	In	L1_1_UI2_IOStatus

- When you have completed selecting the PLC data points, click the **Export variables to LogiCAD** speed button while LogiCAD is running.



- The data points now appear as variables in LogiCAD in a folder under the device folder. The folder is named specific to the technology of the data points, e.g. LIOB for all L-IOB I/Os that are exposed as a PLC variable. An example is shown in Figure 43.

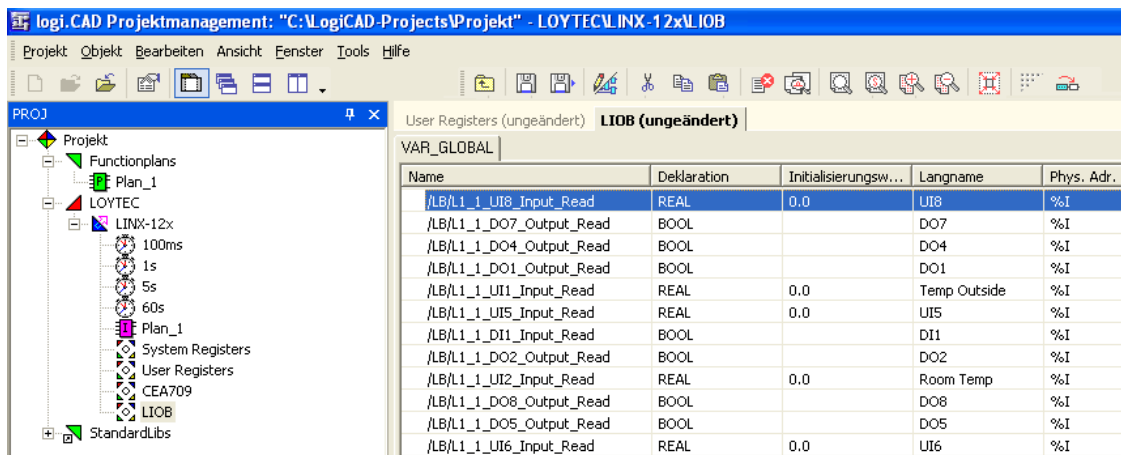

Figure 43: Exposed PLC data points appear in LogiCAD

- Now the logic can be developed on the function plan.
- For later debugging, it is good practice to add online test fields to the drawing, to display the current value of the signals during online test. To do this, right-click on the value output of the left function block and select **Create OLT Field** from the context menu, as shown in Figure 44.

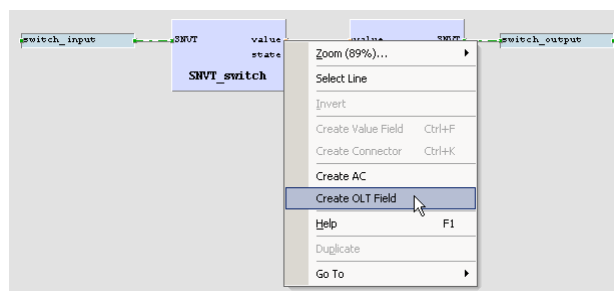

Figure 44: Create online test fields

- Place the fields above and below the drawing as shown in Figure 45, then press the **Save** button to save your changes.

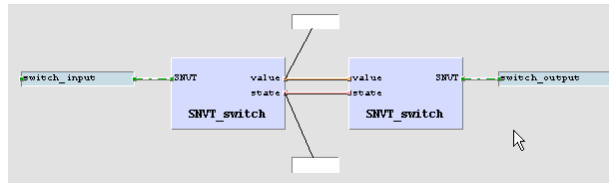

Figure 45: Online Test fields

14. Finally, open the context menu of the **LINX-11x** device again and select **Code Generation**. In the dialog, press the button **Start** to start the code generation process. On success, the code generation window reports Errors=0 and Warnings=1.
15. Close the window by pressing the **OK** button. Now the compiled IEC61131 program can be downloaded to the device. Right-click the tree element **LINX-11x** and select **Download** from the context menu. A connection dialog will appear and ask for the type of connection and additional information.

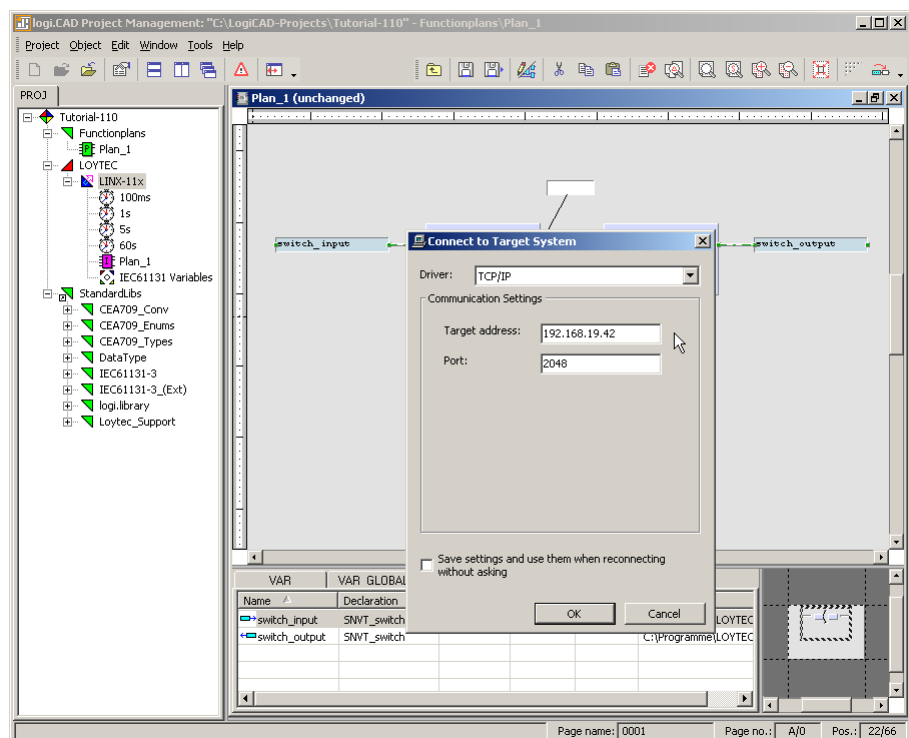

Figure 46: IEC61131 program download

16. Select the TCP/IP communication driver and enter the target address as configured in Section 5.2. Start the download process by pressing the **OK** button.
17. After the download completed check the PLC LED. If it is steady green, the logic is not yet running. Reboot the L-INX to start the IEC61131 program.

5.7 Connect with an OPC XML-DA Client

After the configuration has been downloaded to the L-INX it is ready to serve OPC XML-DA clients. All data points with the **OPC** check box activated will be exposed. Connect to the L-INX using the URL

<http://192.168.24.99/DA>,

given that 192.168.24.99 is the IP address of the device. Note, that by default, writing to OPC tags needs basic HTTP authentication using the password for the operator user. This is 'operator' by default.

5.8 Reset to Factory Defaults

In case the password of the device or the PIN code of the LCD UI has been forgotten you may need to reset the device back to factory defaults to gain access again. On the L-INX models 10X, 11X, 20X, 21X press the service button and power-cycle the device. On the L-INX models with the jog dial press the jog dial and power-cycle the device. Keep the button/jog dial pressed until the port LEDs illuminate orange permanently. Release the button/jog dial within five seconds from that time on to reset the device to factory defaults.

6 Hardware Installation

6.1 Enclosure

The enclosure of the product and its terminal layout are shown on the installation sheet found in the product's box.

6.2 Product Label

The product label on the side of the L-INX/L-GATE contains the following information (for an example see Figure 47):

- L-INX order number with bar-code (e.g. LINX-112, LGATE-950),
- serial number with bar-code (Ser#).

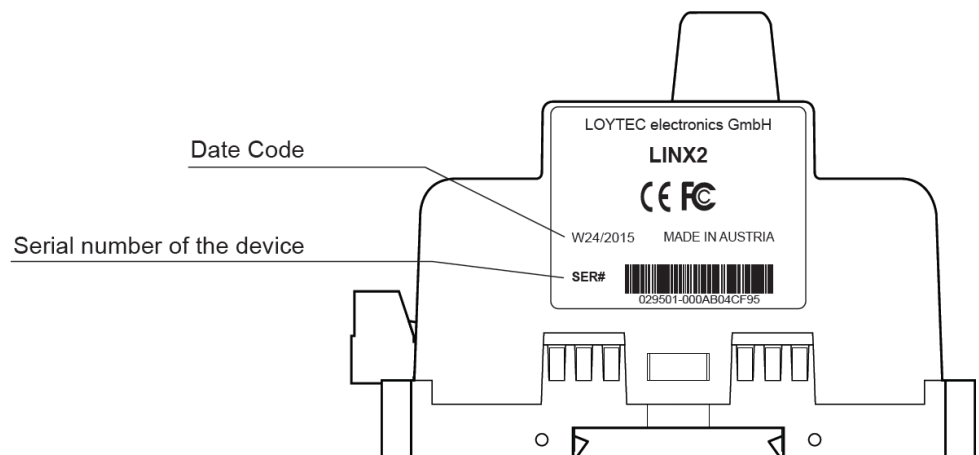

Figure 47: Example product label.

Unless stated otherwise, all bar codes are encoded using “Code 128”. An additional label is also supplied with the device for documentation purposes. The specific contents of the product label are shown on the installation sheet found in the product's box.

6.3 Mounting

The device comes prepared for mounting on DIN rails following DIN EN 50 022. The device can be mounted in any position. However, an installation place with proper airflow must be selected to ensure that the device's temperature does not exceed the specified range (see Chapter 13).

6.4 LED signals

Available LEDs and their location on the respective device model can be found on the product's installation sheet. The installation sheet can be found in the product's box.

6.4.1 OPC LED

The OPC Server LED illuminates green when at least one OPC client is connected to the OPC server. The LED flickers on OPC XML-DA traffic activity.

6.4.2 PLC LED

The PLC LED indicates the state of the IEC61131 kernel and the IEC61131 program (see product installation sheet). Table 3 shows the different LED patterns and their meaning.

Behavior	Description	Comment
GREEN permanent	The IEC61131 program has been stopped	The IEC61131 kernel is running, there is an IEC61131 program, but the program execution was stopped.
GREEN flashing slow at 1 Hz	Normal condition, IEC61131 program running	The IEC61131 kernel and program were successfully loaded. The IEC61131 program is executed.
GREEN flashing fast in an on-on-pause pattern	I/O driver disabled	The I/O driver is disabled, that is that no updates from or the IEC61131 program were handled.
GREEN flashing fast	CPU overload	CPU load exceeded 80%. Modify the PLC program to reduce CPU load in order to guarantee normal system operation (for example, reduce the cycle time of the program).
OFF	No IEC61131 program	No IEC61131 program is loaded or a problem occurred while starting the IEC61131 kernel.

Table 3: PLC LED Patterns

6.4.3 FT Activity LED

The FT port on the device has a three-color LED (green, red, and orange, see product installation sheet). Table 4 shows different LED patterns of the port and their meaning.

Behavior	Description	Comment
GREEN flashing fast	Traffic	
GREEN flashing at 1Hz	The OPC node or LINX-101's router port is unconfigured	On the LINX-101 this LED only stops flashing if both, node and router, are commissioned.
RED permanent	Port damaged	
RED flashing fast	Traffic with high amount of errors	
RED flashing at 1 Hz (all ports)	Firmware image corrupt	Please upload new firmware.
ORANGE permanent	Port disabled	e.g., using LSD Tool
ORANGE flashing fast	Traffic on port configured as management port	e.g., using LSD Tool

Table 4: CEA-709 Activity LED Patterns.

6.4.4 MSTP Activity LED

The MS/TP port has a three-color MSTP Activity LED (see product installation sheet). Table 5 shows the different LED patterns of the port and their meaning. A permanent color reflects a state. Flicker is for 25 ms when there is activity on the MS/TP data link layer.

Behavior	Description	Comment
GREEN permanently, flicker off	Multi-Master, token ok, flicker when traffic	Normal condition on a multi-master MS/TP network.
ORANGE flicker	Sole master, flicker when traffic	Normal condition on a single-master MS/TP network.
RED permanent, flicker GREEN	Token lost state, flicker when transmit attempt	Cable might be broken.
RED flash fast	Transmission or receive errors	This indicates bad cabling.

Table 5: MS/TP Activity LED Patterns.

6.4.5 Modbus LED

The Modbus LED is a three-color LED. Table 6 shows the different LED patterns of the port and their meaning. Flicker is for 25 ms when there is activity on the bus.

Behavior	Description	Comment
GREEN flicker	Traffic, transmission successful	Normal condition.
RED flicker	Traffic, transmission unsuccessful	Device not responding or other network error.

Table 6: Modbus Activity LED Patterns.

6.4.6 EXT LED

The EXT port has a three-color LED (see product installation sheet), which displays link and traffic information on the protocol enabled on the port (M-Bus or KNX TP1). Table 7 shows the different LED patterns of the port and their meaning. A permanent color reflects a state. Flicker is for 25 ms when there is activity on the attached network. The LGATE-951/952 and the LINX-153 have more than one EXT port that all conform to the described behavior.

Behavior	Description	Comment
GREEN permanently, flicker off	LKNX-300 attached, flicker when traffic	Normal condition on a KNX TP1 network.
GREEN flash fast	M-Bus traffic	Normal condition on an M-Bus network.
RED permanent	LKNX-300 not attached, no KNX bus power or port damaged	Check if cabling to LKNX-300 is bad.
RED flash fast	M-Bus transmission or receive errors	This indicates bad cabling. Check if L-MBUS is connected. Check if M-Bus devices are operational.

Table 7: EXT port LED Patterns.

6.4.7 Ethernet Link LED

The Ethernet Link LED lights up green whenever an Ethernet cable is plugged-in and a physical connection with a switch, hub, or PC can be established.

6.4.8 Ethernet Activity LED

The Ethernet Activity LED lights up green for 6 ms whenever a packet is transmitted or received or when a collision is detected on the network cable.

6.4.9 BBMD LED

This LED is available on LGATE-95X only. The BBMD LED is permanent green if BBMD is enabled. Otherwise, it is off.

6.4.10 Wink Action

If the CEA-709 device receives a wink command on any of its network ports, it shows a blink pattern on the CNIP and the CEA-709 activity LEDs. The CEA-709 activity and the CNIP LED turn green/orange/red (each 0.15 s). This pattern is repeated six times. After that, the CNIP LED flashes orange six times if the wink command was received on the IP channel or the CEA-709 activity LED flashes orange six times if the wink command was received on the CEA-709 channel. After that the device's LEDs resume their normal behavior.

6.4.11 Network Diagnostics

The CEA-709 device provides simple network diagnostics via its CEA-709 activity LED:

If the LED does not light up at all, this port is not connected to any network segment or the connected network segment currently shows no traffic.

If the LED is flashing green, the network segment connected to this port is ok.

If the LED is flashing red, a potential problem exists on the network segment connected to this port. This state is referred to as overload condition.

A port overload condition occurs if

- the average bandwidth utilization of this port was higher than 70 %, or
- the collision rate was higher than 5 %, or
- more than 15 % CRC errors have occurred on a port with a power-line transceiver, or more than 5 % on a port with a transceiver other than power-line, or
- the device was not able to process all available messages.

For a deeper analysis of the reason for the overload condition, it is recommended to use a protocol analyzer (e.g., LOYTEC's LPA) or a similar tool. The exact reason of the overload condition can also be determined with the LSD Tool.

6.5 Wiring

The wiring information of the product and its terminal layout are shown on the installation sheet found in the product's box.

7 Concepts

7.1 Universal Gateway

The operating principle of a universal gateway is to connect data points of one network technology to data points of another technology. This is the primary function of the L-GATE product family. Gateway function are, however, also available in the L-INX family.

Data points in the CEA-709 network are known as network variables (NVs). Data points in the BACnet technology are known as BACnet server objects. They have a specific type (e.g. analog input or binary output) and a set of properties, which describe the data point more closely. The actual value is stored in the “Present_Value”. For more information on the mentioned technologies refer to the LINX Configurator User Manual [2].

The typical task in configuring the universal gateway consists of the following steps:

1. Selecting the data points of the network to be mapped (e.g., select the NVs in the CEA-709 network nodes or create new NVs)
2. Select or create matching counterparts of the other technology (e.g., create matching BACnet objects)
3. Create connections between the data points (e.g. connect NVs and BACnet objects).

The connection is the central part of the gateway functionality. It defines, which data points are mapped to which data points. Refer to the Connections Section in the LINX Configurator User Manual [2] for more information.

7.2 Data Point Configuration

Data points are part of the fundamental device concept to model process data. A data point is the basic input/output element on the device. Each data point has a value, a data type, a direction, and a set of meta-data describing the value in a semantic context. Each data point also has a name and a description. The entire set of data points is organized in a hierarchy using a folder structure. Folders can be created as needed and have a folder name and description.

The direction of a data point is defined as the “network view” of the data flow. This means, an input data point obtains data from the network. An output data point sends data to the network. This is an important convention to remember as different technologies may define other direction semantics. If a data point can both receive and send data on the network, its direction is set to value, indicating no explicit network data flow.

The device provides a Web interface for displaying and modifying data point values (see Figure 48). Data points that are structures contain their structure members as sub-data points beneath them. Data point values are typically written by the controller or by the network. For testing purposes the values can also be manually overridden (Set Override). More information on the data point Web interface can be found in the LOYTEC Device User

Manual [1]. For a comprehensive description of the data point configuration on the device please refer to the LINX Configurator User Manual [2].

Name	Dir.	Type	State	Value	Description
State Summary	input	multistate	normal	WARNING (2)	Device status summary
System Time	input	analog	normal	1440776560 s	System time (UTC) in seconds
Time UTC	input	user	normal	"2015 yr" "8 months" "28 d" "15 h" "42 min" "40 s"	UTC Time
Time Local	input	user	normal	"2015 yr" "8 months" "28 d" "16 h" "42 min" "40 s"	Local Time
Unit System	input	multistate	normal	SI unit (1)	Unit System
Unit System Set	output	multistate	normal	SI unit (1)	Unit System Set
CPU Load	input	analog	normal	15.1 %	CPU load in %
Free Memory	input	analog	normal	32067584 Bytes	Free RAM in Bytes
Free Flash	input	analog	normal	158580736 Bytes	Free flash memory in Bytes
Supply Voltage	input	analog	normal	23.4 V	Supply voltage in Volts
System Temp	input	analog	normal	39.5 °C	System temperature of device
Application Vendor	input	analog	invalid value	--	Application vendor ID
Authentication Code	output	analog	invalid value	--	OEM Product Authentication Request
Authentication Result	input	binary	normal	inactive (0)	OEM Product Authentication Result
Serial Number	input	string	normal	017903-8000000FDE95	Serial number
MAC Address	input	user	normal	000AB002A360	MAC address
Firmware Version	input	string	normal	5.3.0	Firmware version
Device IP Address	input	string	normal	192.168.24.150	IP address of the device
Device IP Address 2	input	string	invalid value	--	IP address of the second interface
Device IP Port	input	analog	normal	80	IP port for OPC XML-DA
TZ Offset	input	analog	normal	3600 s	Timezone offset in seconds
Device Status	input	string	normal	<?xml version="1.0" encoding="UTF-8"?>	Device Status
Ethernet Link Mask	input	multistate	normal	Eth 1 + Eth 2 (3)	Ethernet link mask
Hostname	input	string	normal	LINX-KG	Hostname

Figure 48: Data points on the Web interface.

7.3 IEC61131 Variables

IEC61131 variables are used to exchange data with the IEC61131 program. These variables are represented in the data point configuration as register data points and can be connected to other data points, e.g. to CEA-709 NV points, via data point connections.

In contrast to CEA-709 or BACnet variables, IEC61131 variables are always represented as single data point. In case of scalar values (representing CEA-709 scalar or enumeration types) one of the following basic data types might be used:

- **Double:** A register of base type *double* is represented by an *analog* data point. It can hold any scalar value. No specific scaling factors apply.
- **Signed Integer:** A register of base type *signed integer* is represented by a *multi-state* data point. This register can hold a set of discrete states, each identified by a signed stats ID.
- **Boolean:** A register of base type *boolean* is represented by a *binary* data point. This register can hold a Boolean value.

Structured IEC61131 variables, representing for example structured NVs, or customer defined IEC61131 structures, are stored as user type:

- **User:** A *user* data point contains un-interpreted, user-defined data. The data is stored as a byte array. A user data point does not include any other meta-data. This type of data point also serves as a container for otherwise structured data points and represents the entire data structure. User data points can only be connected to other user data points of the same data length.

8 IEC 61131 – L-LOGICAD

To design the IEC61131 program which should run on the L-INX device, the graphical programming tool logiCAD is required. The tool allows creating IEC61131 programs using various IEC61131 programming languages. It offers additional features downloading and debugging of the created program.

In addition to logiCAD, the L-INX Configurator necessary to create an appropriate data point configuration in the automation server. The usage of logiCAD itself is beyond the scope of this manual. Please refer to the logiCAD online help in case of additional questions.

8.1 Overview

The PLC in the L-INX device is intended to perform IEC61131 programs operating on IEC61131 data points. The operating principle is to connect IEC61131 data points to data points derived from CEA-709, BACnet or LIOB network. Figure 49 depicts the usage of data points for IEC61131 programs at the example of using CEA-709 network variables.

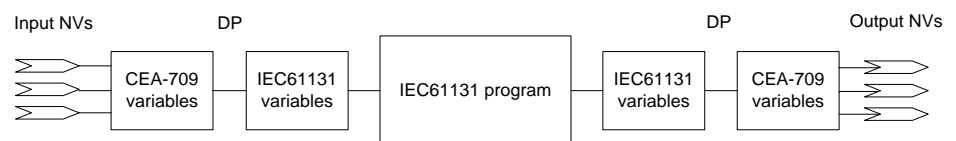

Figure 49 Usage of data points.

Alternatively, data points can also be directly exposed as IEC61131 variables. The data points provide a PLC check box for this purpose. In this use case, not special IEC61131 data points are created and no connections are necessary.

8.2 Installing logiCAD

For developing IEC61131 programs with logiCAD the following components must be installed:

1. L-logiCAD setup package. This package installs the logiCAD software, which is needed to design PLC programs for the L-INX device.
2. L-INX Configurator. This software is required to configure the L-INX device to provide the necessary data points to the PLC and integrate the device into the network.
3. logiCAD license for using logiCAD on the PC. The license is available as a softlock version or as a hardlock version with a USB dongle. On virtual machines it is mandatory to use the hardlock license. How to obtain and install the license is described in this Section.

The L-logiCAD installer installs the IEC61131 programming environment logiCAD and all L-INX related software packages. These packages include the template project for the LINX,

the required software to build IEC61131 programs for the L-INX device, and required extensions to interface to CEA-709 networks. Follow the instructions of the installer to install logiCAD for the L-INX.

The language for the logiCAD user interfaces can be set to German or English using the administration folder of the logiCAD control center. The logiCAD control center can be started from the Windows start menu.

8.2.1 Softlock License

The license to run a copy of logiCAD on any PC is based on a softlock license. In case the original softlock license file was generated for an older L-logiCAD version, the software will request an update signature key for the new L-logiCAD installation. This signature key can be found in the file 'logiCAD_Readme.txt' that is located in the installation directory of the L-logiCAD software.

To obtain and install a new license start logiCAD. The product activation dialog will appear as shown in Figure 50. In this dialog press the button **Download Softlock License**.

Important!

When using Windows7 start logiCAD as administrator in order to allow the script read the computer number code. If there are x's in the code, the code was not read by the script.

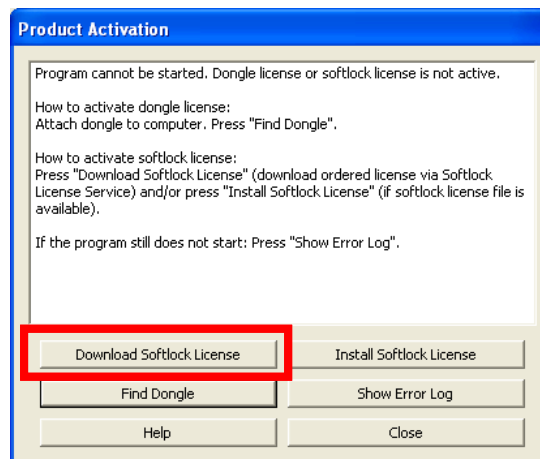

Figure 50: logiCAD Product Activation

Enter the license data provided with the product information on the Web site form as shown in Figure 51. Fill in the **SL-number** and **Licensing Code** from your L-LOGICAD registration form and click on **Download License File**. Save the license file on your computer or have it e-mailed to you.

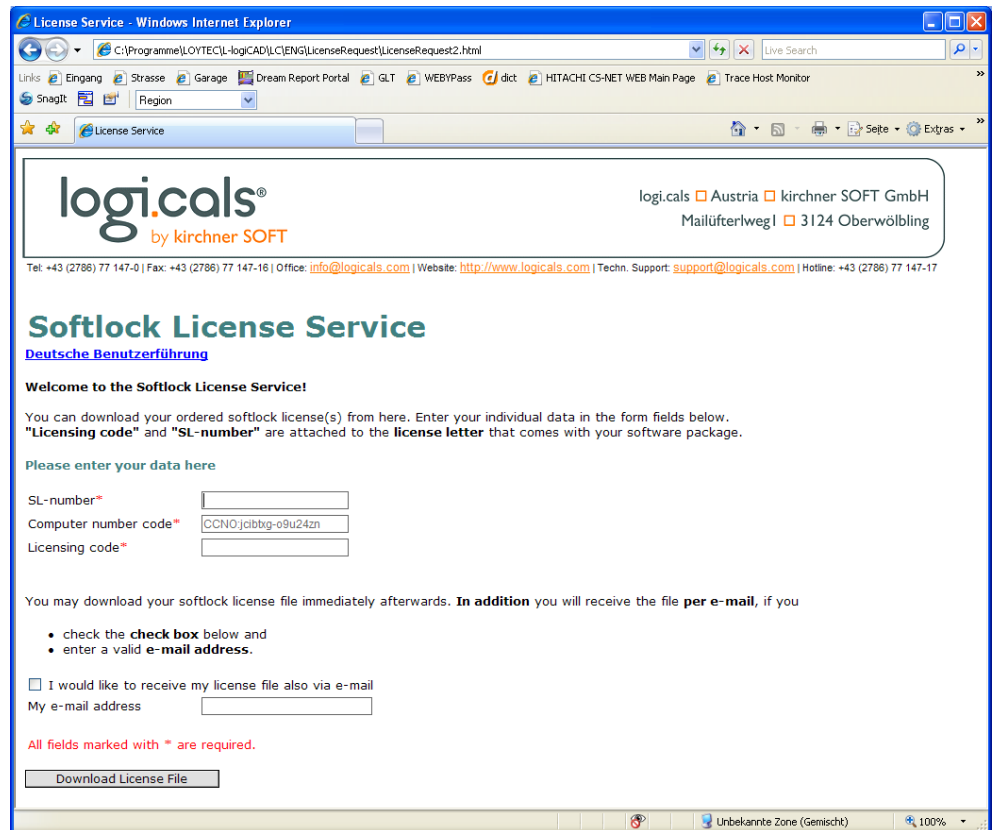

Figure 51: logiCAD softlock license Web form.

Then install the license using the **Install Softlock License** button in the product activation dialog as indicated in Figure 52.

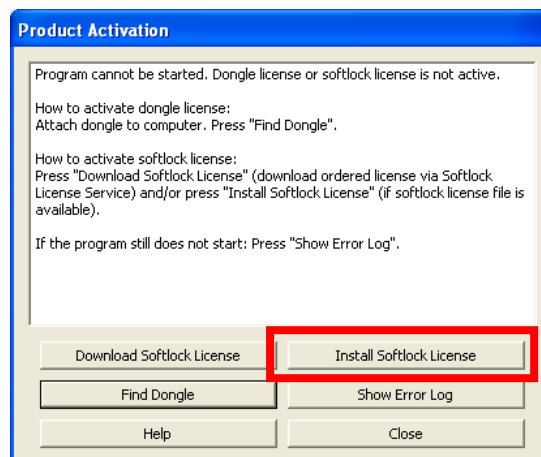

Figure 52: logiCAD softlock installation.

A file requestor dialog opens. Locate the downloaded license file (logiCAD.lf) and click **Open**. Finally click **Close** in the product activation dialog and start logiCAD again. The softlock license is now activated.

8.2.2 Hardlock License

The hardlock license is needed to run a copy of logiCAD in a virtual machine on the PC. It needs to be purchased separately as L-LODICAD-USB and is distributed as a USB hardlock key of type 'CodeMeter'. If no driver for this type of hardlock is already installed on the PC, install the hardlock driver provided on the LOYTEC website. It can be found in Support →

Download and the product selection for L-LOGICAD. After the driver installation has completed, plug in the USB key. It must be recognized as a mass storage device (the details on it show the location 'CodeMeter-Stick'). When starting logiCAD it recognizes the hardlock automatically.

If the driver installation failed, or the USB key was not detected or connected, the window shown in Figure 53 will be shown when logiCAD is started. In this case plug in the hardlock stick, wait for Windows to recognize it and then click **Find Dongle**.

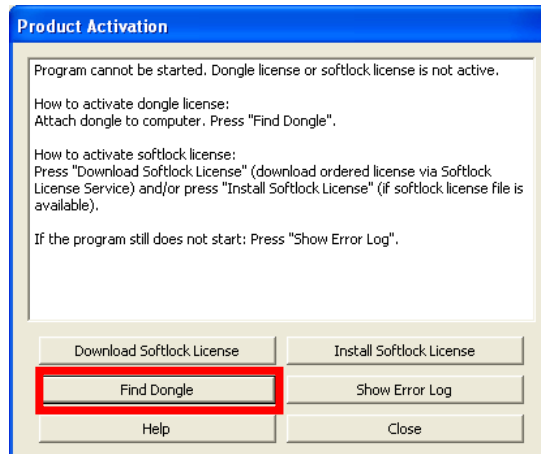

Figure 53: logiCAD Product Activation with Hardlock

Note: logiCAD checks frequently if the USB key is present. When unplugging the USB key, even if logiCAD was successfully started, all major features are automatically disabled. But there is no additional message for the user!

8.3 IEC61131 Project Files

In the L-INX Configurator select the **LogiCAD Files** tab to attach an IEC61131 program and a logiCAD project to the L-INX project. The tab is shown in Figure 54.

If there is an IEC61131 program attached to the project, every time a new configuration is downloaded to the device, the L-INX Configurator asks, if the attached program should be downloaded as well. This way, no logiCAD is required to download a suitable IEC61131 program in a separate step. The project designed in the L-INX Configurator can hold all necessary information to set up a running device:

- IEC61131 data point configuration,
- Data point configuration in the LINX,
- Required connections,
- IEC61131 program.

The logiCAD project directory can also be attached to the L-INX configuration file, in order to include the logiCAD project sources from which the program was compiled.

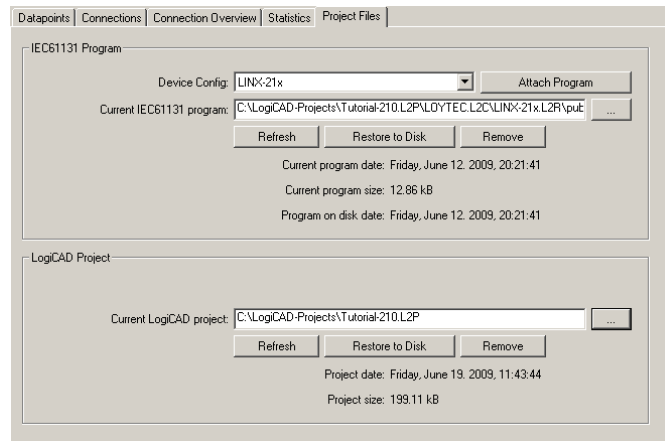

Figure 54: IEC61131 Project Files.

To attach an IEC61131 program or a logiCAD project select the file/folder to attach. The selected data will be attached automatically the project. It can be restored to disk by pressing the **Restore to Disk** button. During the development process the attached data may change several times. To update the attached data, located on the before provided path, press the **Refresh** button.

Every time a logiCAD project is successfully compiled, the file MBRTCode.so, the compiled IEC61131 program, is copied to the *public* directory of the device resource for which the program was compiled. Select this file to attach it to the project of the Configurator. Note that the time and date of the file indicates the time of the last code generation. If logiCAD is not able to build a new program, the old file will not be deleted.

The project will be scanned for device resources and the available devices will be listed in the dropdown box called **Device Config**. Select the desired device and press the button **Attach Program** to automatically attach the correct MBRTCode.so file.

8.4 Working with logiCAD

This section provides all necessary background information how to use the L-INX with logiCAD. For using the L-INX with logiCAD, a predefined project template for the L-INX must be used. Hence, when creating a new project, select the project template “Project for LINX-110”, see Figure 55. For additional information how to create, delete and manage projects please refer to the logiCAD online help.

8.4.1 Managing Variables

On a function plan, three basic types of variables may be created using the tabs shown below the function plan sheet:

- **VAR:** Variables created on this tab will be visible only to the logic designed on this group of sheets. It will not be accessible to any other programs or to any function blocks which are used in this program. It is similar to a 'static' variable declaration in a C code function.
- **VAR GLOBAL:** Variables declared here will be accessible to the entire program, including any function blocks which are called by the program. Function blocks which need to reference this variable need to have a suitable declaration of an external variable (see next point). This declaration is similar to a 'static' declaration of a C variable outside a function, which will be visible to all functions inside the C code module, but not visible to other modules.
- **VAR EXTERNAL:** Variables declared in this list will be treated as open references to a global variable which exists somewhere in the scope of the device on which the program will be executed. This means that a global variable needs to be declared on the device resource, which will be available to all programs running on the device. If the physical address parameter of the variable is set to %I, %O, or %M, the variable will be handed down to the I/O driver of the L-INX for processing. If a suitable IEC61131 variable exists in the data point configuration of the device, its value will be forwarded by the I/O driver between the PLC variable and the data point. If no physical address is set, the variable will only be visible to the PLC programs but not to the I/O driver, which may be used to exchange data between PLC tasks.

The basic data flow between the CEA709 network (or BACnet and other technologies) and the PLC program is depicted in Figure 56.

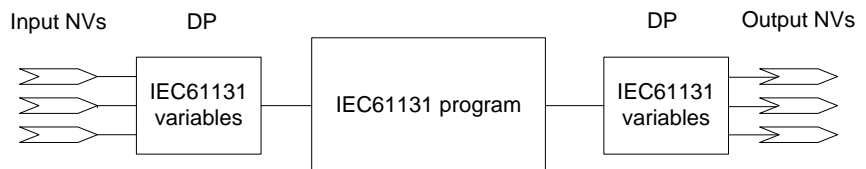

Figure 56: Connecting IEC61131 variables

The place where global variables are created on the device is shown in Figure 57.

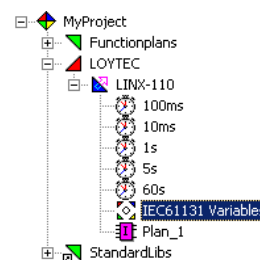
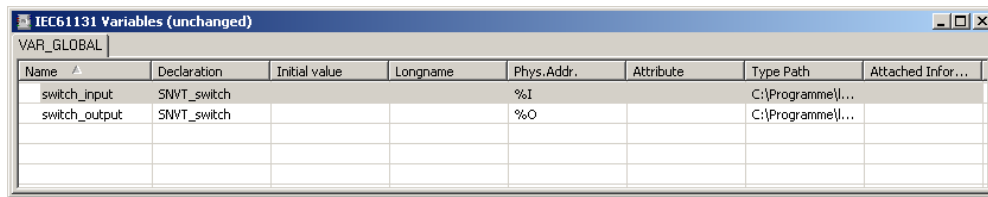

Figure 57: Global Variables Object

When starting a new project, no global variables object is available; it must be created before compiling the IEC61131 application. The global variables object is created automatically by the LINX Configurator when exporting variables to logiCAD.



Name	Declaration	Initial value	Longname	Phys.Addr.	Attribute	Type Path	Attached Infor...
switch_input	SNWT_switch			%I		C:\Programme\l...	
switch_output	SNWT_switch			%O		C:\Programme\l...	

Figure 58: Variables defined in global variables object

Figure 58 shows the contents of a sample global variables object. As shown a global variable is defined by the fields **name**, **declaration** and **phys.addr.:**

- **Name:** The name of a global variable must be unique. The name is used from the IO driver to identify the global variable and from the L-INX Configurator to generate the corresponding IEC61131 data points.
- **Declaration:** Here the type of the global variable is defined.
- **Phys.Addr.:** The IO driver needs to know the data flow direction to be able to update variables. The direction is defined by adding %I for an input variable, %O for an output variable and %M for a marker (input and output). If the address is empty, the I/O driver will not handle the variable, but it may still be used by the tasks running on the device.

Important: *Only ASCII characters can be used for naming the global variables.*

8.4.2 Build and Download the IEC61131 Program

IEC61131 programs, designed using logiCAD, must be cross compiled in order to run on the L-INX device. The prerequisite to compile an IEC61131 program are as follows:

- A program instance with associated program type
- A corresponding global variables object

Right click on the LINX-110 resource, see Figure 57, and select Code Generation. Please refer to the logiCAD online help for the meaning of the options. Take care about the option breakpoint support, see section 8.4.5 for details.

After successfully finished code generation, the IEC61131 application can be downloaded to the LINX-110. Right click on the LINX-110 resource and select download.

The IEC61131 program can be downloaded to the LINX-110 device via TCP/IP, CEA-709 and RS232:

- **TCP/IP:** Enter the IP address of the LINX-110 device. Do not change the default communication port (2048). This is the easiest and fastest way to connect to the device.
- **CEA-709:** Select the network interface to use and fill out all other fields, see Figure 59. Alternatively, select the network interface and press Auto-detect via Service-Pin. Then press the service pin on the LINX-110 device. Note that this connection method requires an installed LOYTEC network interface.

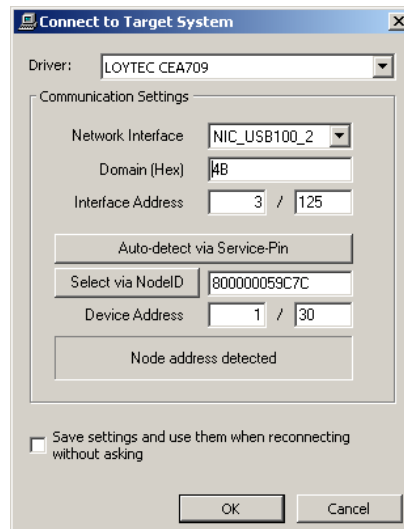

Figure 59: Connect via CEA-709

Important: *To be able to communicate with the LINX-110 device via CEA709 the LINX-110 must be commissioned.*

- **RS232:** To connect via RS232 select LOYTEC RS232 as Driver and LOYTEC as transmission protocol. All other values are set correctly per default.

8.4.3 Usage of NVs, Technology Converters

To use CEA-709 variables the content of the NVs must be converted to IEC61131 compliant data types. Look for “Elementary and Generic Data Types” within the logiCAD online help to get information about the available data types. Technology Converters are used to perform the transformation from CEA-709 data types to IEC61131 data types. All Technology Converters are summarized in the subfolder CEA709_Conv located in the StandardLibs folder.

Depending on the type of the NV there are three different ways to use the NV within IEC61131 programs:

- Simple NVs that hold only one scalar value, e.g. SNVT_amp:

Those kinds of NVs are represented as IEC61131 REAL values within logiCAD. There is no additional conversion necessary. Figure 71 shows an example program for scalar data types.

- Simple NVs based on an enumeration, e.g. SNVT_date_day:

The active identifier of the enumeration is represented as Boolean value. When using NVs based on enumerations, Enumeration Converters are used to identify the current state. There are two kinds of Enumeration Converters. First, the Enumeration Converters that convert the enumeration types to Boolean types, grouped in the folder **Convert from CEA709_Enums**. Second, the Enumeration Converters that convert several Boolean inputs to an enumeration type, grouped in the folder **Convert to CEA709_Enums**.

- Structured NVs that consists of a number of fields, e.g. SNVT_switch:

On structured NVs two tasks must be performed by the Technology Converters. First the structure of the NV is mapped to IEC61131 conform data types. Second, if necessary scaling factors are applied. Similar to the Enumeration Converters, the Technology Converters are split up into two subfolders. The first one, which

converts the NV into IEC61131 compliant data types, is located in the folder **From_CEA709_Types**. Technology Converters to set up NVs based on IEC61131 data types are grouped in the folder **To_CEA709_Types**.

Figure 60 shows the three possibilities how to use NVs within an IEC61131 program.

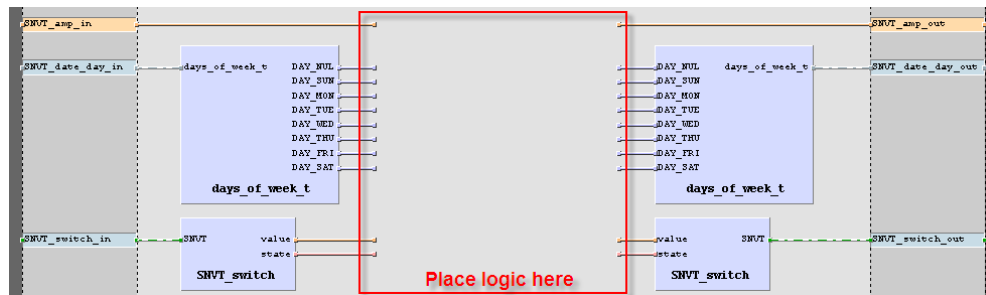

Figure 60: Usage of NVs

If a structured NV comprises enumerations types, these enumerations are not split up by the Technology Converter. To get the value of the enumeration, connect an Enumeration Converter to the corresponding output of the Technology Converter.

For every Technology Converter and Enumeration Converter an online help window, displaying the interface description is available. Select the Technology Converter and press F1 to get the interface description.

8.4.4 IEC61131 Program Cycle Time

IEC61131 programs are performed in a periodical manner. IEC61131 tasks are used to control the execution of an IEC61131 program. As shown in Figure 57 several default tasks are defined within the template project. Right click on the clock symbol and select properties to change the cycle time of the task.

As described in section 8.4 a program instance is required to execute the IEC61131 program. The cycle time of the IEC61131 program is controlled by the task assigned to the program instance. In order to change the cycle time right click on the program instance and select properties. In the upcoming window the task assignment for the selected program type can be changed, see Figure 61.

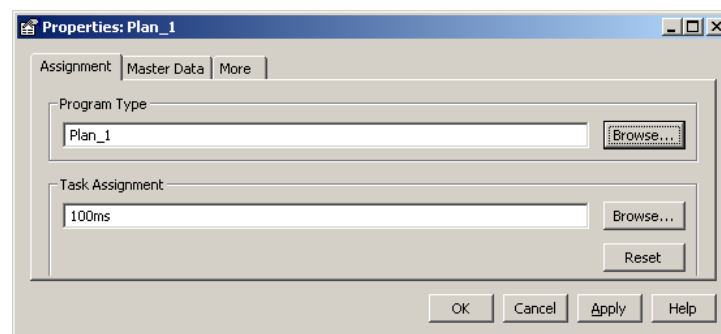

Figure 61: Task assignment

Please take care when defining names for the tasks. The names displayed in the project view are symbolic names, they do not correspond to the settings for the cycle time, even if the L-INX template project use the configured cycle time as task name.

8.4.5 CPU Overload

Several conditions affect the CPU utilization of the IEC61131 program. As a result it is not possible to predict the system load caused by the IEC61131 program. E.g. the following parameters are of particular importance when designing IEC61131 programs:

- Number of inputs and outputs handled by the I/O driver.
- Complexity of the logic in the running IEC61131 program.
- Number of simultaneously running program instances on one L-INX.
- Cycle time of IEC61131 programs.
- logiCAD breakpoint support and force-able code enabled or disabled

The developer of the IEC61131 program is able to check the current system load within the Web UI. To get a rough estimate of the CPU load investigate the PLC-LED. Every time, the system load increases 80% for a certain period of time, the PLC-LED switches to red until the system load goes below 80%.

In case of CPU overload, the IEC61131 program may not be able to finish its work within the defined cycle time. Adapt the program in order to reduce the total system load below 80%. Here are a few tips to keep the CPU load down:

- Increase the cycle time, so that the task may finish in time before the next cycle start is scheduled. The PLC kernel will always schedule the next run at an absolute time, no matter how long the previous run took, in order to compensate for irregular execution times and keep a steady cycle time if possible.
- Reduce the number of I/O variables, to reduce the load caused by exchanging data between the PLC program and the data points of the automation server.
- Reduce the number of independent tasks and try to place as much functionality as possible into one task. Every running task will call the I/O driver for new inputs and outputs independently, therefore two tasks running at a 1s cycle time each will cause twice the I/O load of one task running at 1s cycle time.
- Take special care about the complexity of function blocks which are used a lot. Bad performance of one such block may dramatically increase CPU load if it needs to be calculated several hundred times in one cycle.
- Try to disable breakpoint support and force-able code when generating code for the target, to get the most efficient PLC code out of your logic.
- For complex designs, it may be possible to add a state machine using SFC elements and enable/disable large parts of the logic based on the current state of operation.
- Whenever a function does not need to calculate new output values under certain conditions, use the built-in EN input of the block to disable execution and thus reduce the required CPU time, instead of adding your own 'Enable' input which causes the logic to 'behave' as if it would be disabled, while it is actually calculated every cycle. This is similar to power saving methods used in modern electronic devices. Parts which are not required are put into a low power mode instead of keeping them running in an unproductive state.

8.4.6 I/O Driver Settings

Before starting the IEC61131 program, the device performs a check on all defined global variables, which are marked %I, %O, or %M in the physical address parameter. For all

variables, which cannot be loaded, because the corresponding data points cannot be located on the device, the I/O driver reports a warning in the system log and shows a listing on the Web interface.

Since IEC61131 program and the data point configuration are downloaded separately, it may be possible that the IEC61131 program does not match the currently active data point interface. In this case it could be dangerous to write values onto those potentially wrong data points. The fact that there are any variables that could not be loaded is taken as an indication for a configuration mismatch. The **I/O Check** feature disables the I/O driver of the IEC61131 kernel automatically in this situation. This setting is enabled by default in a new configuration. In the rare case that it is intended to have missing data points, this feature can be disabled in the Configurator. In the system settings de-select the I/O check (see Figure 62). If the I/O driver is disabled, it can be temporarily enabled again on the Web interface until the next reboot.

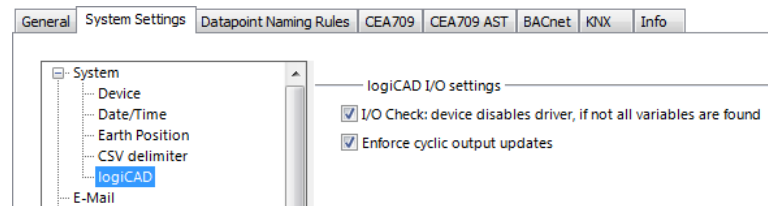



Figure 62: System settings for logiCAD I/O settings.

The project setting **Enforce cyclic output update** enables a cyclic update of output data points, which will ensure that those output data points will contain the calculated value after each cycle. This is the default setting. It can be disabled, if the output data point shall be written only if the calculated value changes. In this mode the output data point can be modified over the Web UI for debugging reasons until the IEC61131 program calculates a new value. This mode can also be used to implement an event-style output operation.

8.4.7 PLC Conflicts

PLC output variables are cyclically updating the respective data points, which are configured as PLC out. If those data points are also written to by other objects (e.g. output of a math object, receiver in a connection) this will not have the desired effect. Also favorites that are PLC out and linked to a PLC out data point will result in two different PLC output variables writing to one and the same data point.

The **PLC Conflicts** tab provides information for detecting such write conflicts on PLC out data points. The tab shows a list of PLC write conflicts and the writing objects, which are in conflict with a PLC out data point. Each reported conflict line can be selected. By clicking the **Go to data point** button  the Configurator navigates to the conflicting object.

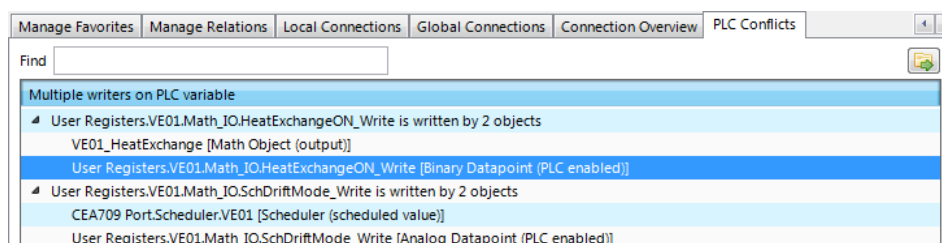

Figure 63: PLC conflicts tab.

An example is shown in Figure 63. The user register 'HeatExchangeON_Write' is written to by the PLC, because it is PLC out. But the register is also an output in the math object 'VE01_HeatExchange'. To resolve the conflict, either remove the register from the math object or remove the PLC out check box from the user register. For doing the latter, select

the conflict line reporting the register and select **Go to data point**. Then uncheck PLC out on the data point.

8.5 Workflows for the L-INX

8.5.1 Starting with Data Points

This workflow is based on defining data points used for the IEC61131 program in the L-INX Configurator and then export them to logiCAD. Figure 64 presents the basic steps of this workflow. To follow the steps refer to the quick-start description of Section 5.6. Refer to the LINX Configurator User Manual [2] about additional information how to gather information from the network.

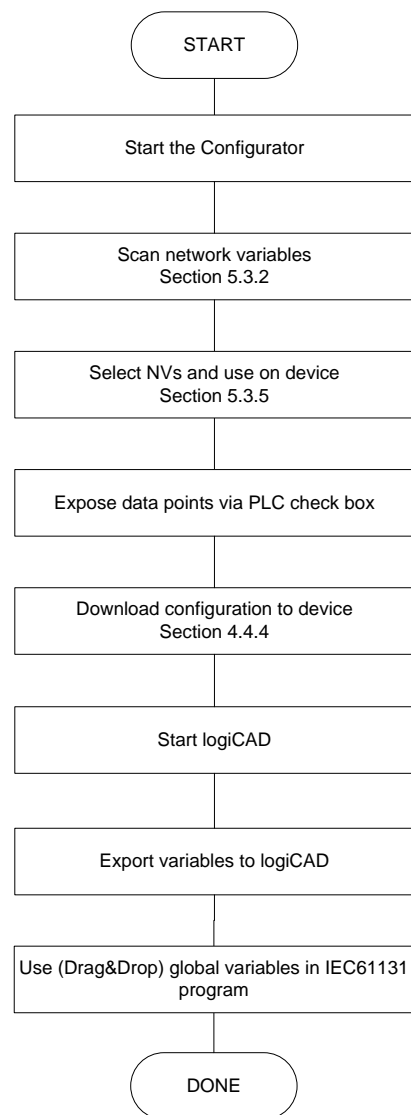

Figure 64: Start with network based information

It is assumed that there are already network data points (CEA-709, BACnet, L-IOB, etc.) available. Clicking the Export variables to logiCAD button in the Configurator creates the IEC61131 variables in logiCAD. The following rules are applied in this process:

- The name of the global variables object is derived from the technology base folder (e.g. CEA709, User Registers, etc.). If there is no matching global variables object

one is created. If there is already a suitable global variables object, the existing variables are saved.

- There is already a suitable global variables object: If there is an old and new variable with identical name, the type of the variable is checked. In case of a type mismatch of the old and new variable, the old one is discarded and the new one is imported. Additionally a warning is printed on the **Error-state viewer**.
- The name of the global variables object represents the folder name in the L-INX Configurator.

After exporting the data points as global variables to logiCAD, they can be used in the Functionplan 'Plan_1'. To open the respective global variables folder double-click on it. To use the imported variables simply drag and drop the required global variable on to the Functionplan, see Figure 65. The external variables (see Section 8.5.2) are automatically created when adding the global variable to the Functionplan.

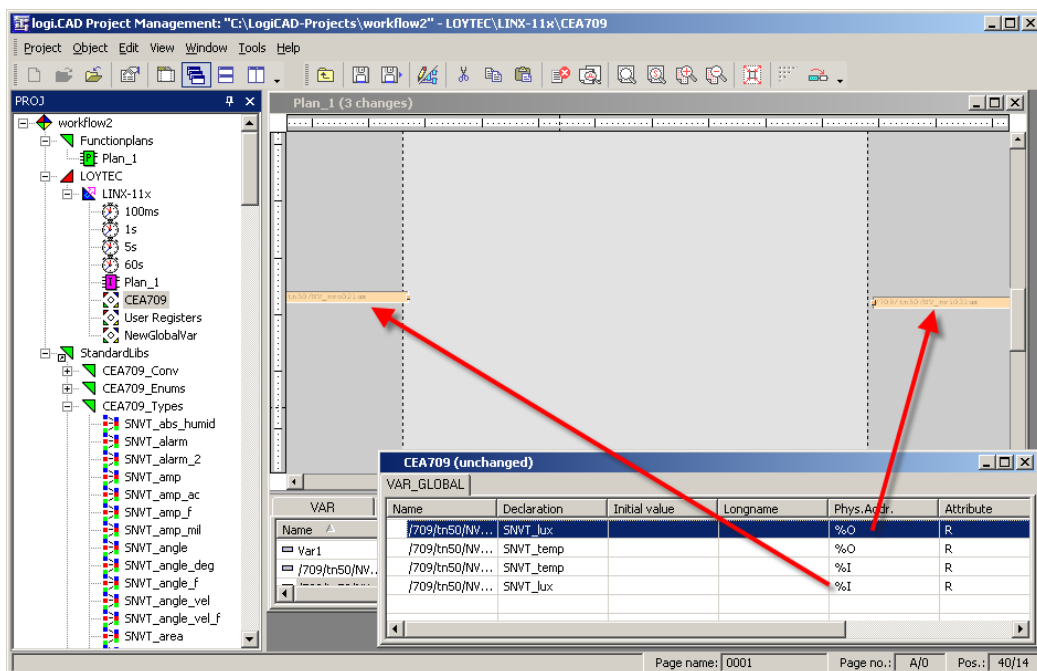

Figure 65: Adding global variables to Functionplans

After adding function blocks that perform the expected work, the IEC61131 program is ready to compile and download (see Section 8.4.2).

8.5.2 Starting with logiCAD

This section introduces a workflow how to develop a new IEC61131 program from scratch using logiCAD. Figure 66 shows the necessary steps to perform. For starting a new logiCAD project refer to the quick-start of Section 5.6.

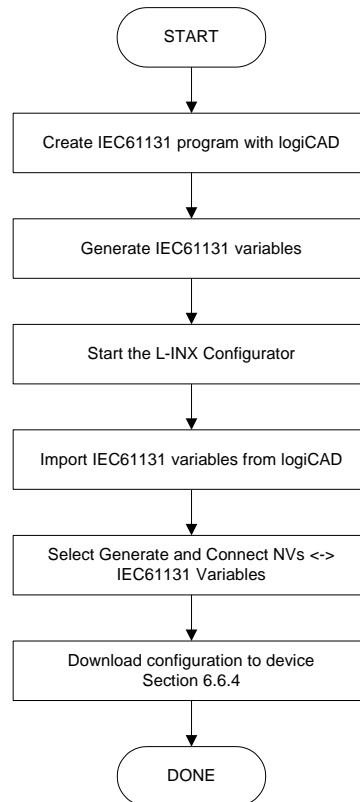

Figure 66: Starting with logiCAD

After creating a new project for a L-INX resource and opening the Functionplan Plan_1 an empty input area is shown, similar to Figure 67.

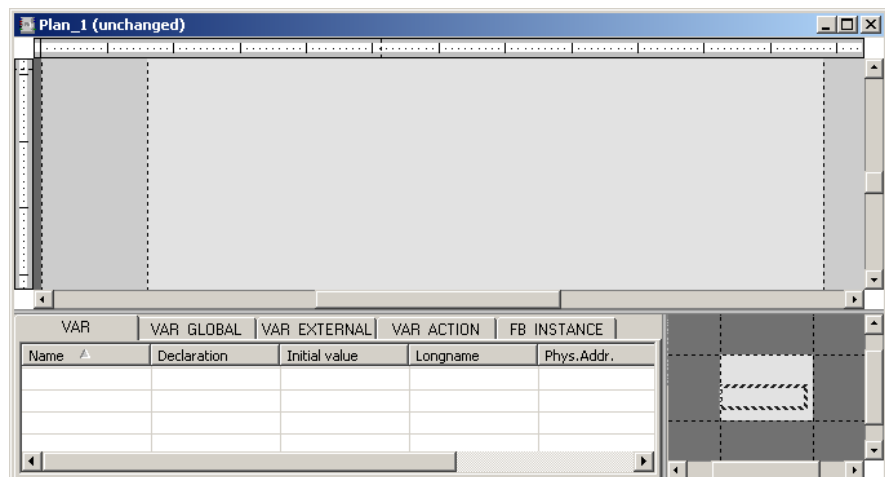

Figure 67: Start new function plan

The dark grey areas on the left and right side are intended to place the input and output variables, the light grey area is used to place the functional blocks.

As described above, global variables are used to interface IEC61131 data points on the LINX-110 device. As assumed for the current workflow, the IEC61131 data points are created on information based on the global variables exported from logiCAD. Hence, for designing the program, external variables are used during the design phase. To create a new

variable select the **VAR_EXTERNAL** tab, right click in the declaration area and select **New**, as shown in Figure 68.

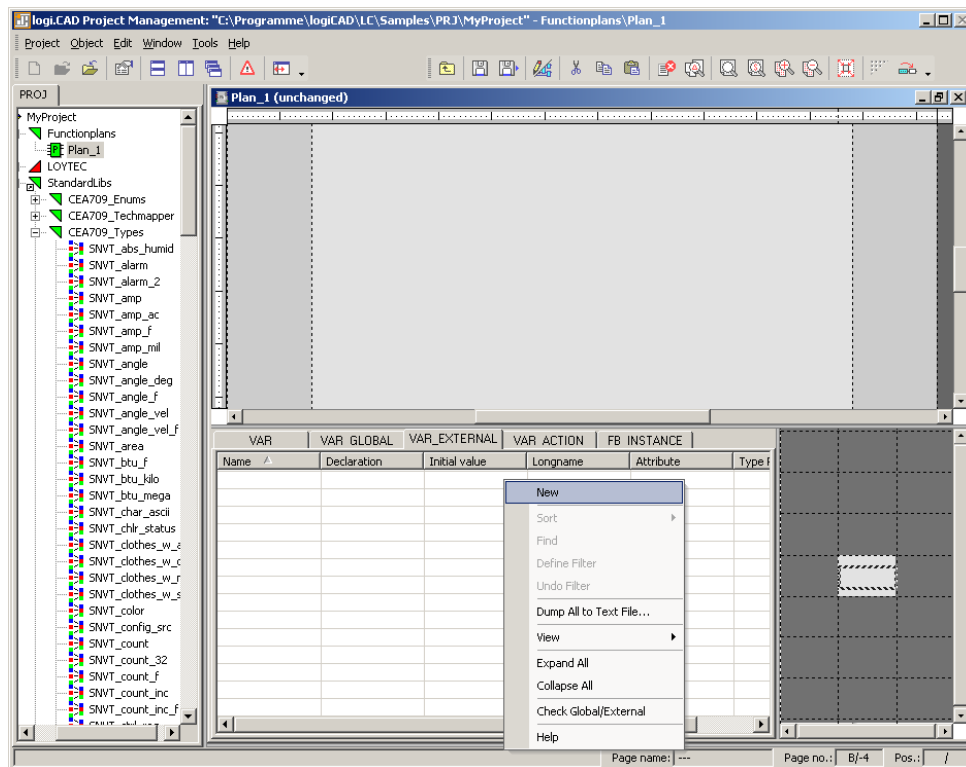

Figure 68: New external variable

In the upcoming dialog the name and the type declaration of the variable must be specified. The type declaration can be done directly by prompting the type into the declaration field, by selecting the type from the pull-down menu or by drag-and-drop of a specific type from the project tree, see Figure 69. Finally, the new variable is added by pressing the **Add** button.

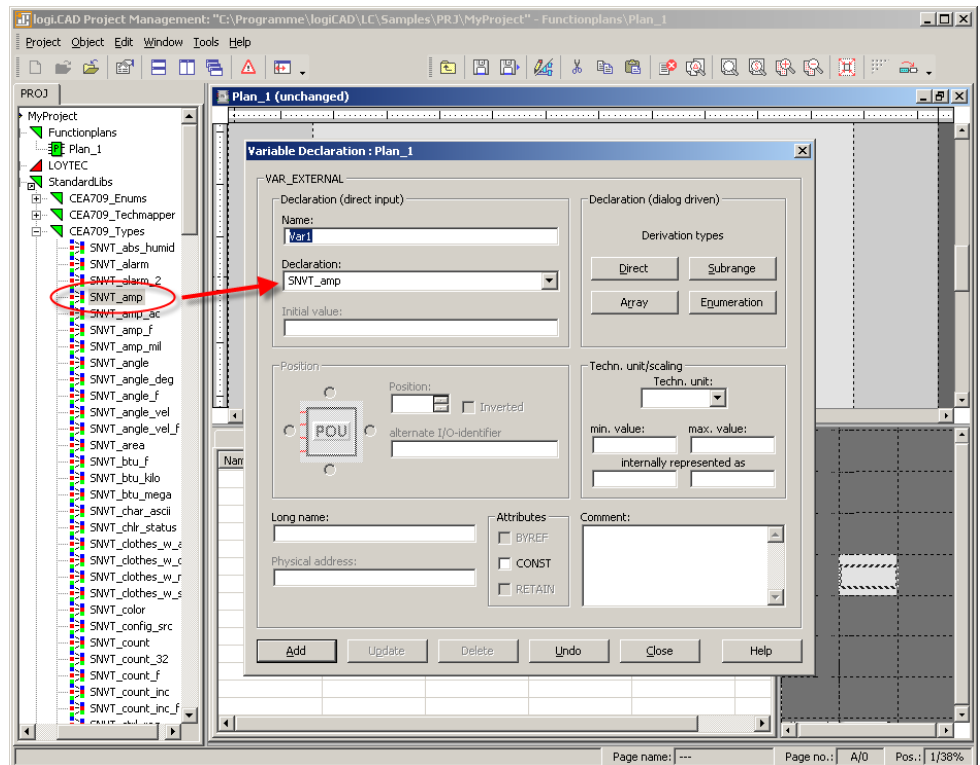

Figure 69: External variable type declaration

The created variable is added to the declaration area and placed to the drawing area by drag-and-drop. At this time the direction of the external variable is not defined, it can be used as input as well as output variable.

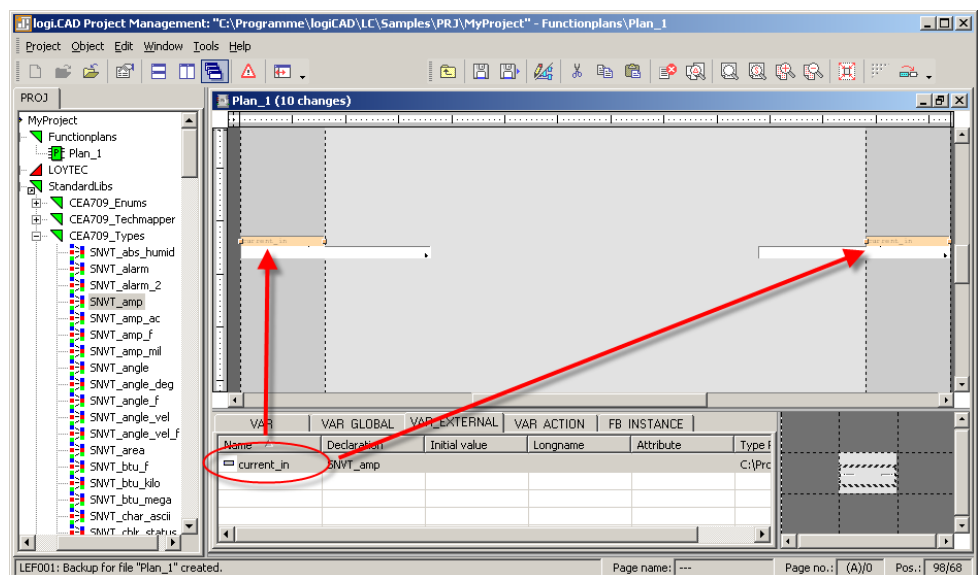

Figure 70: Drag-and-drop external variable to drawing area

Please take care to use an external variable only as input OR output. After adding the external variables to the drawing area, add function blocks to perform the desired actions, see Figure 71 for a sample configuration.

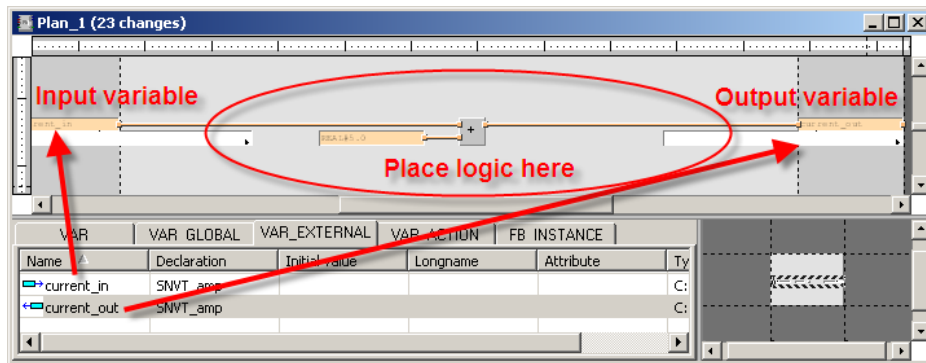

Figure 71: Use external variables

The Functionplan 'Plan_1' represents now a simple program. It adds a defined value to the value of the input variable and sends the result to the output variable.

Add all expected functionality to the 'Plan_1' or use different Functionplans to split up the expected functionality into smaller pieces. But take care about the name and type declaration of external variables when using more than one Functionplan. All external variables with the same name refer to the same global variable.

After adding all functionality, global variables matching the requirements of the defined external variables, must be generated. A tool automatically performs the process of generating the global variables object and the required global variables.

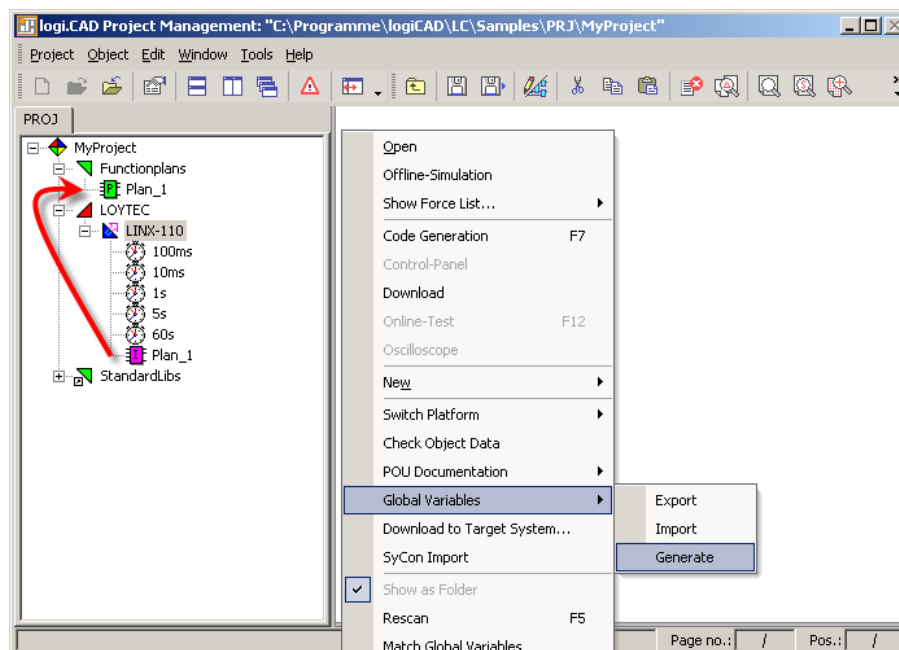

Figure 72: Auto-create global variables

To start the creation of global variables, based on external variables, **Save** all changes, then right click the L-INX device and select **Global Variables** → **Generate**. Then the selected L-INX resource is parsed and every program instance found is checked for external variables. In Figure 72 the type instance Plan_1 refers to the Functionplan 'Plan_1', as defined in Figure 71. If there are more Functionplans than the predefined 'Plan_1' appropriate program instances for these plans must be added to the resource before creating the global variables. Anyway, only Functionplans referred from program instances are executed.

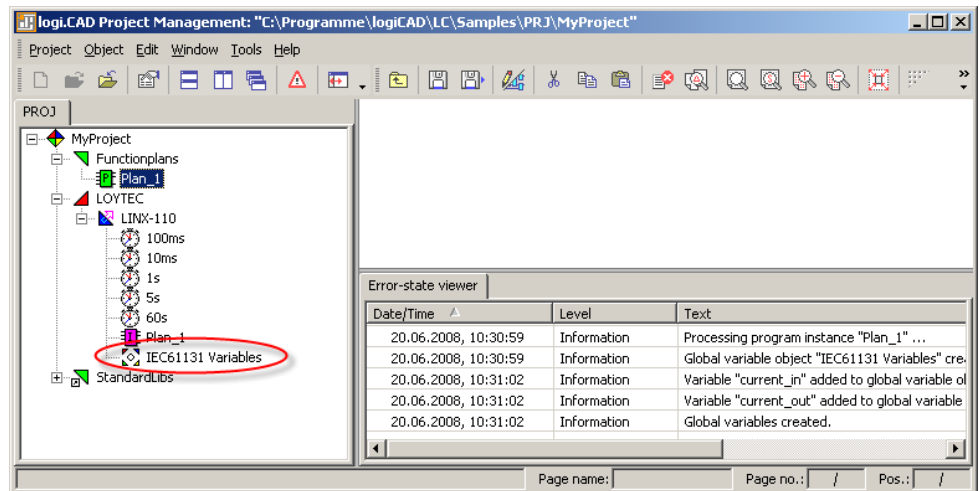

Figure 73: Created global variables object

Now there is a global variables object called IEC61131 Variables available, containing all global representations of the external variables defined before. The **Error-state viewer** reports all processed program instances and added variables, see Figure 73 for details.

The global variables are created based on the following rules:

- The direction of the variable is determined based on the graphical representation, shown in Figure 74.

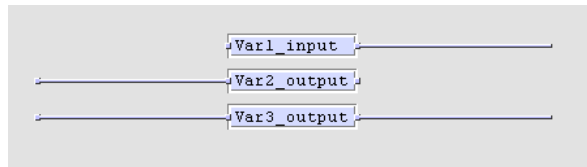



Figure 74: Direction of global variables

Every external variable connected on the right terminal results in a global input variable. External variables connected on the left terminal or on both sides results in a global output variable. Variables connected on both sides can either be used for the force update feature (see section 8.6.1) or as marker (see section 8.6.4). As the tool can not distinguish between these two possibilities, per default a global output variable is created.

- If there is already a global variables object, only new variables are added. In case of external variables using the same name as an already existing global variable, the new definition is used and a warning is printed in the **Error-state viewer**.
- In case of two Functionplans, each referring to a global variable with the same name but a different type, the creation process is stopped and an error is printed in the **Error-state viewer**.

Now the IEC61131 program is ready to compile and download, refer to section 8.4.2 for details.

Based on the above created global variables corresponding IEC61131 data points are created on the L-INX. For doing so, start the L-INX Configurator and click the speed button  **Import variables from logiCAD**. Data points are created in the **IEC61131 Variables** folder.

The Configurator reports the results of the import. For the import process the following rules are applied:

- New variables are added
- Variables with same name and type are ignored
- If there are variables with the same name but different type or direction, the variable to import is ignored and a warning is added to the import log.

The name of the folder to import the new variables corresponds to the name of the global variables object. Figure 75 shows the result of the import process.

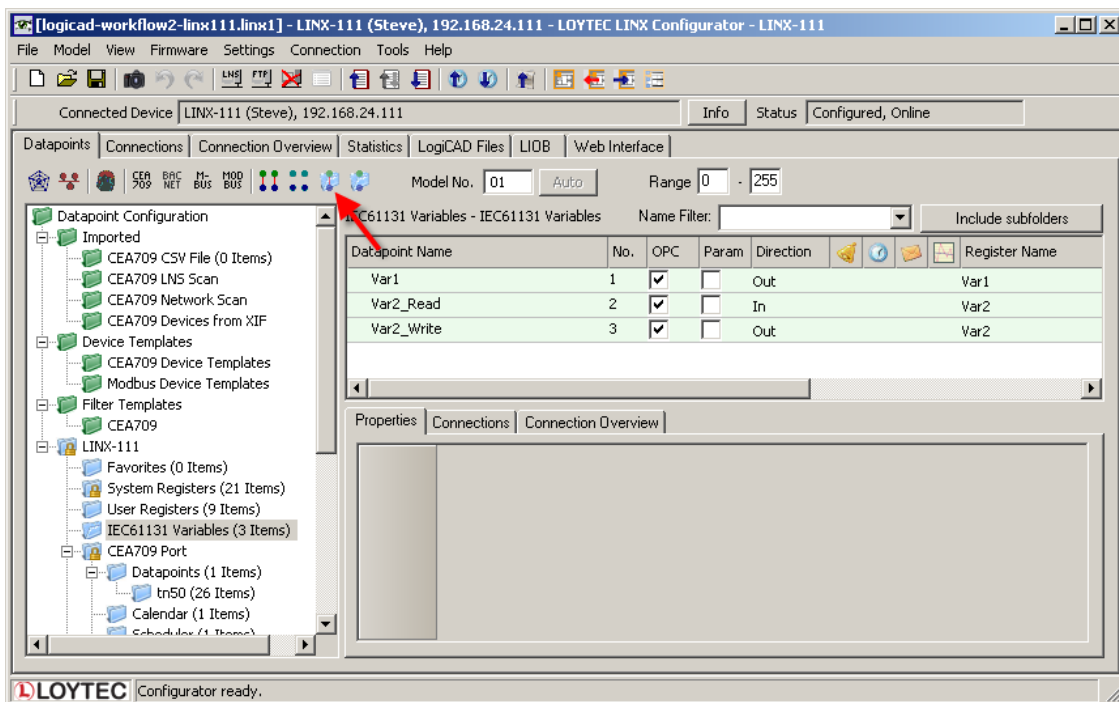

Figure 75: Connect IEC61131 variables

To create the appropriate network data points for all imported IEC61131 variables select the **IEC61131 Variables** folder and press the button **Generate and Connect Network <-> IEC61131 variable from folder**. Check the log output for errors and finally download the configuration to the L-INX device.

After rebooting the L-INX device the IEC61131 program is up and running. Check the PLC LED for potential overload.

8.5.3 Pre-compiled IEC61131 Program

In opposite to the last two chapters it is assumed that there are already some components finished, hence starting up from scratch is not suitable. Second, there is the possibility to have an already defined IEC61131 program or an already fixed network interface.

Starting with an already precompiled IEC61131 program results in a similar workflow as presented in Section 8.5.1. The difference is that all logiCAD related tasks are missing. As the IEC61131 program is compiled, the name of the IEC61131 data points is already fixed. The definitions for the data points must be available either in form of a CSV file to import to the L-INX Configurator or as part of a L-INX Configurator project. If the network interface for the L-INX was not already defined, the L-INX Configurator can be used to generate and connect the needed data points.

Additionally, there is the possibility that also the network data points are already fixed or that a given, user-defined interface is necessary. Then the developer has to connect the IEC61131 data points to the corresponding network data points by himself.

Finally, after downloading the configuration and rebooting the L-INX, the IEC61131 program can be downloaded to the L-INX via the Web UI or the L-INX Configurator. After a final reboot the L-INX loads and executes the IEC61131 program.

8.6 Additional Features

8.6.1 Force Update Functionality

Per default the IEC61131 program only sends updates on changed output values. Every program cycle the input values are fetched, the IEC61131 program is executed and the calculated values are sent to the output driver. If the old values are identically with the new one no updates are sent to the IEC61131 data points. As a result no update is sent to the network.

For some applications, e.g. for a scene controller, it is necessary to send an update on request. E.g. every time the input value is updated, the output value is forwarded to the network, regardless if the value of the output value was changed or not.

For implementing this feature, special vendor blocks are available. First it is necessary to check if there was an update on a selected input within the last execution cycle of the running IEC61131 program. That functionality is offered by the function block **Update Notify** located in the StandardLibs→Loytec_Support folder. Second, an output must be forced to send an update even if the value was not changed. The function block Force Update is used for that functionality, it is located in the StandardLibs→Loytec_Support.

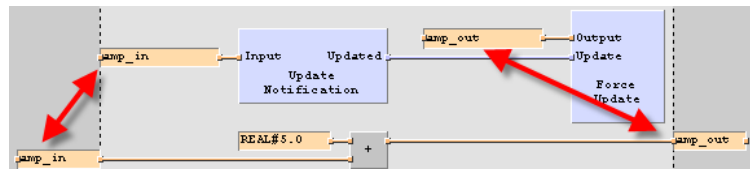

Figure 76: Force update

Figure 76 depicts how to use the force update functionality. Besides of the part of the IEC61131 program that defines the calculations to perform (lower half of Figure 76), additional logic for the force update functionality is required. The global input variable that is monitored for changes is connected to the Update Notification function block. As a result, the Boolean output 'Updated' is set to TRUE for one program cycle, if the value of the connected variable has been updated since the last cycle start. To force the I/O driver send out an update, the global output variable, which shall be updated, is connected to 'Output' of the Force Update block. Hence, every time the 'Update' input of the Force Update block is TRUE, the connected global output variable sends out an update at the end of the program cycle.

Important: *Every global variable connected to the update notification or force update block must be connected via the right-hand side terminal!*

8.6.2 Using UNVT variables

Similar to the predefined CEA709 data types and the technology converter functions, user-defined network variable data types can be used. The L-INX Configurator supports the developer to generate the type definitions needed for UNVTs and enumerations based on resources files. LONMARK

To generate type definitionf for UNVTs in logiCAD

1. Start the L-INX Configurator.
2. Select the menu Tools → Export NV Resource File....
3. Select the resource file to be exported. Select structured text as format and export the file to a location of your choice by clicking **Export Selected**.

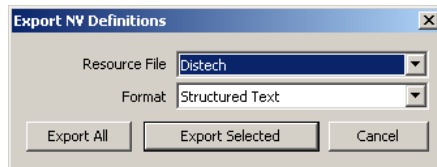

4. To import the created type definition file into logiCAD, add a new library to the project. Right-click on the created library and select **Export/Import → Start ST-Import**.
5. Select the file to be imported and check the **Error-state viewer** for the results of the import process.

Using the newly created data types, suitable technology converter function blocks can be created. For each UNVT type, create a normal function block to convert an input of the UNVT type to a number of standard IEC61131 data types and vice versa. You may look at the technology converter blocks for SNVT types which are provided by LOYTEC, to get ideas how to implement your own converter functions.

8.6.3 Create Your Own Data Type

For special applications, custom IEC61131 compliant data types may be created by the user, which do not correspond to any CEA709 network type but should still be available as a data point on the L-INX automation server, in order to access the data point value from the Web interface or over XML as a parameter. Further, such data points can also be made persistent, which makes variables of such custom data types persistent.

Most of the IEC61131 data types may be used as global variables on the device and the L-INX Configurator will be able to create a suitable register data point for the IEC61131 data type. Supported data types include custom enumeration types (a multi-state register with the required states will be created automatically), strings (a string data point with a maximum length of 128 characters will be built), structures and simple arrays.

If such structured variables shall be mapped to a data point, which shall only be persistent to store the structure but no access to its elements are required in the data point interface create a suitable register data point during the IEC61131 variable import. In this case the data size of custom structures cannot be determined automatically, so the L-INX Configurator does not know how to create a suitable user data point. As a workaround, the type name must contain the desired size of the data point in bytes, for example: MyStructuredType(UT16) will tell the L-INX Configurator to create an IEC61131 register of type 'user' with a length of 16 bytes, to hold the data for the IEC61131 structure defined in the logiCAD program.

As an alternative, structures and arrays the logiCAD type definitions can be exported to the Configurator using structured text. The Configurator builds custom structured data point types in the logiCAD category out of the structured text definitions. In this case, the exact data size of a user register is determined by the structured data type. Structure members of the logiCAD types are represented as a tree of sub-data points. logiCAD arrays (like ARRAY [1..16] OF INT) are represented as a series of single data points where each data point represents one array element. Note, that the array in logiCAD can still be access by index.

To Use logiCAD Types in User Registers

1. In logiCAD right-click on the library with the types that shall be exported and select **Export code...**

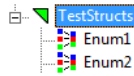

2. In the export dialog choose '.ST' as the export configuration, select the option single file and choose a target file (see Figure 77). Then click **Export**, which creates the structured text file.

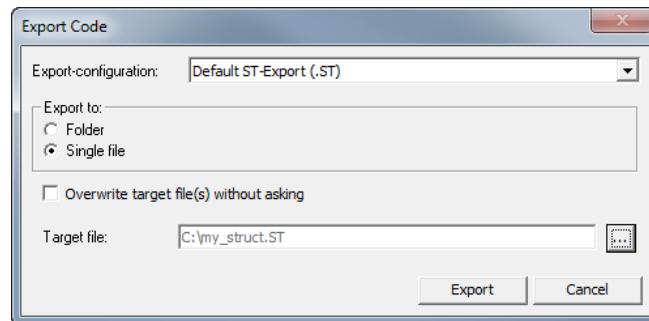

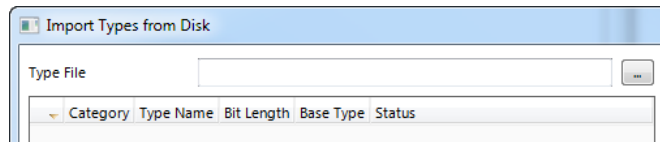

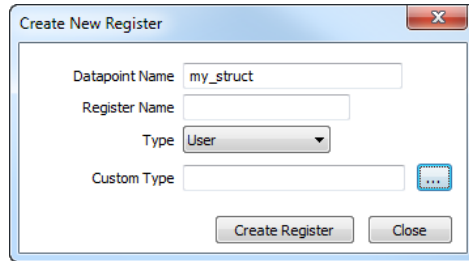

Figure 77: Export logiCAD types as structured text.

3. In the Configurator go to the menu **Tools → Manage Structured Types**.
4. In the dialog choose the type **Category** 'logiCAD'.
5. Click the speed button **Load types from disk** .
6. In the dialog **Import Types from Disk** click on .



7. In the file selector dialog, choose the file type Structured Text '.ST' and open the previously exported file.
8. The available types in the structured text file appear on the left-hand side of the dialog. Transfer all listed types to the Configurator by clicking . Alternatively select specific types and click . Then click **Close**.
9. In the **Manage Structured Types** dialog, the imported logiCAD types are now listed. Click **Close**.
10. Now you are able to create a structured user register. For **Custom Type** choose one of the imported logiCAD structure types.



8.6.4 Using Persistent Data Points and Markers

Persistent data points are data points on the device that hold their value even after power loss. In the IEC61131 program there is no difference in handling global variables connected to persistent data points or to non-persistent data points. When using global variables on the device resource that shall retain their values after a reboot, the respective data points need to be configured with the persistent flag in the L-INX Configurator.

Global input variables marked as persistent, supply the IEC61131 program every time with the last received, valid data, even after a power failure. To enable this behavior, set the respective input data points persistent in the L-INX Configurator and download the data point configuration to the device.

Global variables declared as marker can be used as input and output variable in IEC61131 programs. LogiCAD is not able to distinguish markers from global output variables used in combination with the force update feature, see Figure 76. As a result it is not possible to create a global variables object holding markers automatically. The procedure as described in Section 8.5.1 is not able to decide when to create an output variable or a marker. Markers must be created manually by adding them to the global variables object and setting the physical address to %M.

8.6.5 Using Retain Variables

Retain variables can be used to maintain certain states or parameters of a program over a reboot in those variables, which cannot be kept in persistent data points. Typically, input variables (%I) will be marked as retain variables. For doing so check the **RETAIN** attribute in the variable declaration when creating or editing a variable as shown in Figure 78.

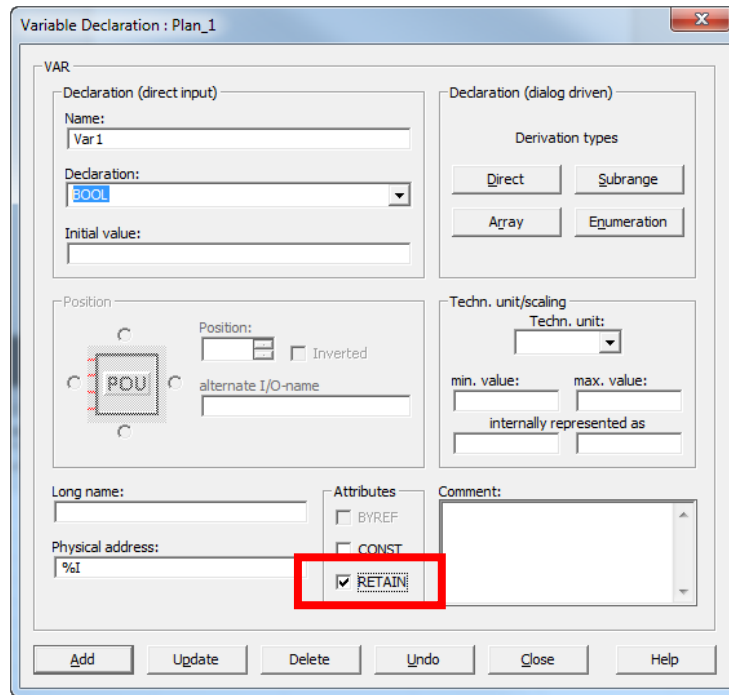

Figure 78: Declaring a retain variable.

The retain attribute should be used in global variables and local variables on function plan only. Global variables on the device resource are managed by the I/O driver and must not use the retain attribute. Instead data point persistency (see Section 8.6.4) must be used for those variables. Furthermore, it is not recommended to mark local variables in function blocks as retain variables.

The contents of retain variables are written to Flash storage every 5 minutes and when shutting down the device. This provides good compromise between write granularity for normal operation and ensuring Flash life-time. If the contents shall be written explicitly at a defined time, use the **RetainCtl** function block located in the **logi.library/Data** folder. Connect the store input (S) and set this input TRUE for one cycle to trigger writing retain data. Make sure to set the input back to FALSE after this cycle to avoid multiple consecutive writes.

8.6.6 L-INX System Registers, System Time

L-INX system registers, such as the system time or the CPU load, can be used within IEC61131 programs. Therefore, for each system input variable, a global input variable of type UDINT may be created within the IEC61131 program. Then, connections to the appropriate system registers are created manually with the L-INX Configurator.

To use the system time within the IEC61131 program, connect the AtoDT converter (located in the StandardLibs->IEC61131-3_ (EXT) folder) to the global input variable that receives the system time.

8.6.7 Code Protection

There are 4 data points used for code protection. These data points, in combination with an adapted IEC61131 program, can be used to protect your 61131-Program Intellectual Property. Please contact LOYTEC sales for further information.

8.6.8 Using Structured Data Point Members

Some network technologies provide structured data points. Their types are defined by the network technology and are available in the Configurator. Those structure types can either

be used in logiCAD by implementing a technology converter (see Section 8.4.3) or by exposing the sub-data points of the respective structures.

To Use Sub-Data Points in logiCAD

1. In the Configurator, expand the structured data point and expose the desired sub-data points of its structure members to the PLC.



Datapoint Name	No.	OPC	Param	PLC	Direction
mod1_Read	1	<input checked="" type="checkbox"/>	<input type="checkbox"/>	<input type="checkbox"/>	In
byte_0	1.1	<input checked="" type="checkbox"/>	<input type="checkbox"/>	<input checked="" type="checkbox"/>	In
byte_1	1.2	<input checked="" type="checkbox"/>	<input type="checkbox"/>	<input checked="" type="checkbox"/>	In

2. Export the variables to logiCAD. The exposed structure members appear for example as ‘UR/mod1_Read.byte_0’ in the ‘User Registers’ global variables block.
3. Export the types for the respective type category in the menu **Tools → Manage Structured Types...**. This opens the structured types management dialog.
4. Choose the type **Category**, e.g. ‘Modbus’.

Category

5. Click the speed button Save to disk .
6. In the dialog **Export Type to Disk** choose a **Disk Repository Path** and select the extension ‘.ST’ for structured text.

Disk Repository Path 

7. Copy all listed types to the disk repository by clicking . Alternatively select specific types and click . Then click **Save** and exit the dialog.
8. In logiCAD create a new library folder, e.g. ‘modbus_types’.
9. Right-click on that new library and select **Export/Import → Start ST Import**. In the file dialog choose the previously exported structured text file.
10. The type definitions are now available in the new library.

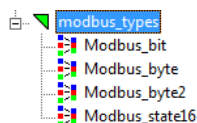

8.6.9 BACnet Server Objects

BACnet server objects provide additional functionality compared to other network technologies. The most important tasks in an IEC61131 program are:

- Reading sensor data from BACnet input objects,
- writing to commandable BACnet objects with a priority,
- revoking values from commandable BACnet objects,
- handling objects when out of service.

The default data flow direction for a commandable BACnet object (e.g. AO) is input to the PLC (%I). This means its value is commanded over the BACnet network and the logiCAD

processes the resulting value. The default for non-commandable BACnet objects (e.g. AI) is output (%O). This means the logic writes the value, which is read out of the object over the BACnet network. With this type of variables the BACnet objects are treated as variables of the IEC61131 program.

When exposing local I/O to BACnet server objects, the BACnet objects represent the I/O values and the IEC61131 program behaves like a user from the network on those objects. Typically sensor values are connected to BACnet input objects (e.g. AI). To read the sensor value the PLC needs an input variable. Since the default data point direction is output, a separate access data point for the PLC must be created. For doing so, use the **Add/Remove BACnet properties** option from the context menu of the data point list and create a read data point for the Present_Value. Figure 79 shows an example, where the PLC uses the input `‘/BAC/AI2.Present_Value_Read’` to get the sensor values from AI2.

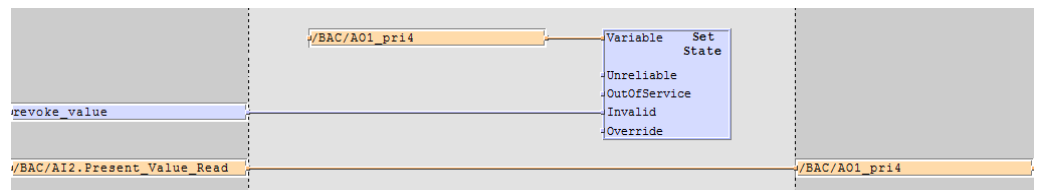

Figure 79: PLC with BACnet objects.

BACnet output objects (e.g. AO) are connected to actuator I/Os. On those BACnet objects the PLC behaves like a user from the network and needs to write and revoke values at certain priority slots. For writing with a certain priority to a commandable object, a priority write data point needs to be created (see LINX Configurator User Manual [2], Section BACnet Configuration, Write and Read with Priority). This data point is configured with a BACnet write priority in the Configurator and used as an output in the PLC. The example in Figure 79 writes with priority ‘4’ to AO1 over `‘/BAC/AO1_pri4’`.

To revoke values in commandable server objects, the **SetValueState** function block must be used. It is located in the **Loytec_Support/Service** folder. The I/O variable of the controlled BACnet object is connected to the **Variable** input of the function block. A Boolean signal needs to be connected to the **Invalid** input. When this input changes to TRUE, the value is revoked at the respective priority slot. When it remains TRUE in the next cycle the service function block is idle. Figure 79 shows an example, how to revoke a value in ‘AO1’ at priority slot ‘4’.

With the out-of-service feature BACnet server objects can be decoupled from the sensor and actuator I/O equipment. When taken out of service, the I/O variables of the PLC are then decoupled from the network. The input variable Present_Value_Read of an AI no longer tracks the sensor value but reflects the value set in the AI from a BACnet OWS. This holds true for all non-commandable BACnet objects. Writing to the priority output variable of an AO only updates the priority array but no longer drives the actuator. This holds true for all commandable BACnet objects.

The out-of-service state is reflected in the data point status and can be accessed with the **ValueState** function block. This function block reads the value state and is used in a similar fashion as the **SetValueState** function block.

8.6.10 Custom Serial Protocols

A logiCAD program can implement simple custom serial protocols using the **SerialComm** function block. The logic program assigns the Baud rate settings for the protocol as well as a logical *bus number*. This bus number can be selected on the port configuration Web UI in order to activate the custom serial protocol on that port.

Custom serial protocols with the following communication properties can be supported:

- ASCII protocol: The serial communication block works with strings that are transmitted and received.
- Line-Oriented: Each command and reply is modeled as a text line. The line can be terminated by any combination of CR and LF.
- Start/End Character: If not line-oriented, a start and end character can be specified to detect start and end of a frame. The end character must be escaped in the frame content.
- Master/Slave: The serial communication block is a master, which sends requests over the serial port and expects slave(s) to respond. The serial communication block can also implement a slave, which receives requests and creates responses.
- Addressing Information: If the serial protocol has more than one slave, each request must have address information, which selects a specific slave. Especially for RS-485 bus communication address information is required. Since frames sent out are also received, they need to be filtered out by address.

To start the implementation of a custom serial protocol use the function block **SerialComm** located in the StandardLibs→Loytec_Support→Service folder. Add a bus number and communication settings as a string (e.g., „38400-8N1-X“) as shown in Figure 80. Best practice for an implementation is to use an SFC-based state machine. All necessary input and output signals are available on this function block. The minimum number of states is Idle, Rx, Tx. For a full specification of this block use the F1 help.

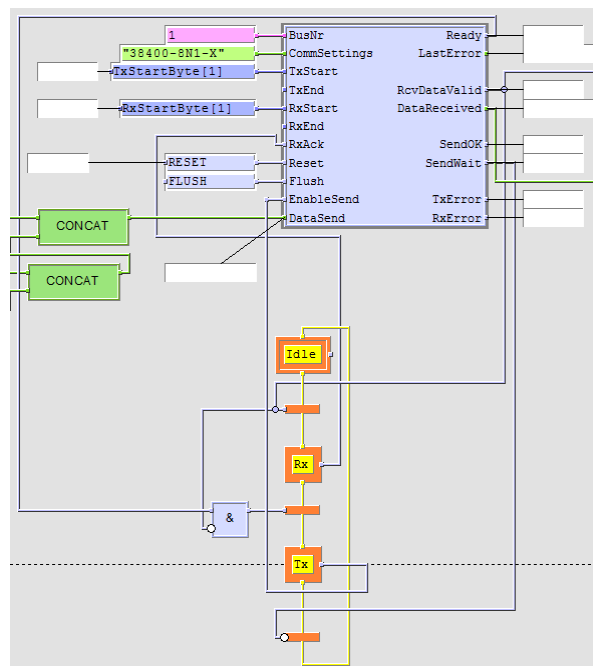

Figure 80: Example for the SerialComm block.

String processing may build commands from data point values and extract data from responses, which are written to data points. The data points should be user registers that are organized into a separate sub-folder for the custom serial protocol.

9 Firmware Update

The L-INX and L-GATE firmware support remote upgrade over the network and the serial console.

To guarantee that the device is not destroyed due to a failed firmware update, the firmware consists of two images:

1. The fallback image,
2. the primary image.

The fallback image cannot be changed. Thus, if the update of the primary image fails or the image is destroyed by some other means, the fallback image is booted and allows reinstalling a valid primary image. When the device boots up with the fallback image, the all port LEDs are flashing red.

The firmware image is distributed in a firmware ZIP archive that applies to all L-INX and L-GATE models.

9.1 Firmware Update via the Configurator

The primary image can be updated using the Configurator. For this purpose, it is recommended to have the device connected to the Ethernet and to have a valid IP configuration (see Section 5.2). The Configurator must be installed as described in the LINX Configurator User Manual [2].

To Update the Firmware using the Configurator

1. Start the Configurator from the Windows Start menu: Start → Programs → LOYTEC LINX Configurator → LOYTEC LINX Configurator.
2. Select the menu: **Connection** → **Connect via FTP**. This opens the FTP connection dialog as shown in Figure 81.

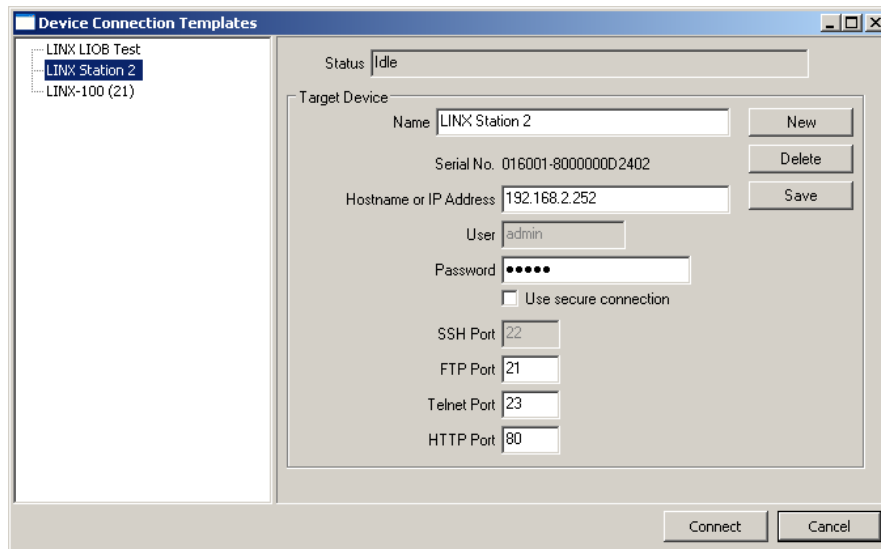



Figure 81: FTP connection dialog.

3. In the connection dialog, enter the IP address of the device as well as the admin user's password. The password can be changed via the Web interface.
4. If the device uses other port settings than the standard settings or the device is operated behind a NAT router, adapt the FTP and Telnet ports accordingly.
5. Click on **Connect**.

Note: Alternatively, one can also connect via LNS. A firmware upgrade over an FT-10 channel, however, needs a lot more time to complete than over IP.

6. Optionally, check for updates by selecting the menu **Help → Check for updates** This function checks for new firmware and Configurator versions.
7. Select the menu: **Firmware → Update ...**
8. This opens the **Firmware Update** dialog as shown in Figure 82. Click on the button  and select the firmware image.

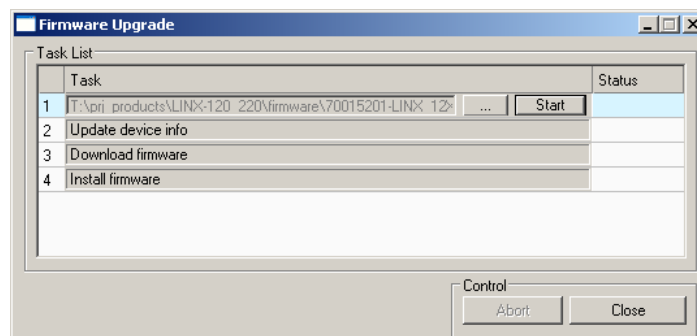

Figure 82: Firmware Update dialog of the Configurator.

9. Click on **Start** and observe the download progress.
10. When the download is complete, a dialog appears. Click **OK**.
11. In the Firmware Update dialog, click **Close**.

12. The device's firmware has now been successfully upgraded.

9.2 Firmware Update via the Web Interface

The device's firmware can also be upgraded using the Web interface. This option can be found in the **Config** menu under the **Firmware** item. For more details refer to the LOYTEC Device User Manual [1].

9.3 Firmware Update via the USB Port

The device's firmware can be upgraded using a USB memory stick. The LCD display provides a menu to select and perform the upgrade. Select **Device Management** »» **USB Storage** »» **Firmware Update** and choose the firmware file. For more details refer to the LOYTEC Device User Manual [1].

10 Troubleshooting

10.1 Technical Support

LOYTEC offers free telephone and e-mail support for the L-INX product series. If none of the above descriptions solves your specific problem please contact us at the following address:

*LOYTEC electronics GmbH
Blumengasse 35
A-1170 Vienna
Austria / Europe*

*e-mail : support@loytec.com
Web : http://www.loytec.com
tel : +43/1/4020805-100
fax : +43/1/4020805-99*

or

*LOYTEC Americas Inc.
N27 W23957 Paul Road
Suite 103
Pewaukee, WI 53072
USA*

*e-mail: support@loytec-americas.com
Web: http://www.loytec-americas.com
tel: +1 (512) 402 5319
fax: +1 (262) 408 5238*

10.2 Packet Capture

Please refer to the Troubleshooting Chapter in the LOYTEC Device User Manual [1] to learn more about packet capture on the LOYTEC device.

11 Application Notes

11.1 The LSD Tool

Please refer to application note “AN002E LSD Tool” for further information about the LOYTEC system diagnostics tool for the LINX-10X.

11.2 Use of Static, Dynamic, and External NVs on a Device

Please refer to application note “AN009E Changing Device Interface in LNS” for more information on the static NV interface, XIF files, device templates and the use of static, dynamic, and external NVs on LOYTEC gateway products.

12 Security Hardening Guide

This guide contains security-relevant information for operating the product on IT networks. The information refers to the firmware version and the instructions found in the previous chapters of this User Manual.

12.1 Installation Instructions

Install the device over the Web interface:

- Set up the basic device functions and protocol settings as described in Section 5.2. When connecting over the Web UI use `https://` in the URL.
- Set a secure password for the admin and operator accounts.
- Disable the HTTP, FTP, and Telnet servers in the IP port configuration as described in the LOYTEC Device User Manual [1]. Note, that FTP and Telnet are disabled in factory defaults as of firmware 7.0.0.
- Create a new HTTPS server certificate as described in the LOYTEC Device User Manual [1].

12.2 Firmware

The device is equipped with one piece of software. This is the firmware image and its related firmware version. The firmware is distributed as a downloadable file. The device can be upgraded by placing the firmware image onto the device using the procedure described in Chapter 9.

12.3 Ports

This Section lists all ports, which may be used by the device. The ports are default settings for their respective services. If not stated otherwise, the ports can be changed.

Required Ports:

- 80 tcp: This port is opened by the Web server and the OPC XML-DA server. It can be disabled if OPC XML-DA is not required. The port can be changed.
- 1628 udp/tcp: This is the data exchange port for CEA-852 (LON over IP). It is required for the primary function of the device to exchange control network data between routers over the IP network. Each device needs this port open. The port can be changed.
- 1629 udp/tcp: This is the configuration server port of CEA-852. Exactly one device in the system needs this port open. Other devices register with the configuration server to form the IP-852 channel list. The port can be changed.
- 47808 udp: This is the data exchange port for BACnet/IP. It is required for the primary function of the device to exchange control network data between routers over the IP network. Each device needs this port open. The port can be changed.

Optional ports not necessary for the primary product function. They can be disabled as described in the installation instructions in Section 12.1:

- 21 tcp: This port is opened by the FTP server. The port can be changed and disabled.
- 22 tcp: This port is opened by the SSH server. The port can be changed and disabled.
- 23 tcp: This port is opened by the Telnet server. The port can be changed and disabled.
- 161 tcp: This port is opened by the SNMP server. This port is disabled by default. The port can be changed.
- 443 tcp: This port is opened by the secure Web server for HTTPS. It can be disabled.
- 5900 tcp: This port is opened by the VNC server, if it is enabled. This port is disabled by default. The port can be changed.
- 502 tcp: This port is opened, if Modbus TCP is configured in slave mode. This port is disabled by default. The port can be changed.
- 3671 udp: This port is opened by KNXnet/IP, if KNX is enabled on the Ethernet interface. This port is disabled by default. The port can be changed.
- 1630 udp/tcp: This port is used by the CEA-709 RNI and for the remote LPA. The port can be changed and disabled.
- 2048 tcp: This port is opened by the logiCAD online test. It cannot be changed. The service can be disabled but the port will remain open.
- 16028/16029 udp: These ports are opened for LIOB-IP on the device. These ports cannot be changed. They can be disabled.
- 2002 tcp: This port is opened by the Wireshark protocol analyzer front-end. This port is disabled by default. The port can be changed.
- 4840 tcp: This port is opened by the OPC UA server. This port is disabled by default. The port can be changed.

12.4 Services

Required services:

- CEA-852 (LON over IP): Primary function of the device. This service is in accordance with the standard ANSI/CEA-852-B.
- BACnet/IP: Primary function of the device. This service is in accordance with the standard ANSI/ASHRAE 135-2010.
- OPC XML-DA: This Web service provides access to data points over the OPC XML-DA standard.

Optional services not necessary for the primary product function. They can be disabled as described in the installation instructions in Section 12.1:

- HTTP: Web server. It provides a Web-based configuration UI. The Web UI can be disabled after setting up the device. The Web service is also used for the Configurator connection for configuration, firmware upgrade, and access to the log file.
- HTTPS: Secure Web server. It provides a Web-based configuration UI using HTTPS. It is also used for a secure Configurator connection.
- SSH: SSH server. It provides secure access to the device console menu over the network.
- FTP and Telnet: The FTP and Telnet server is used for connection to the device by the Configurator for configuration, firmware upgrade, and access to the log file. On devices without SSH these services must be enabled during device configuration.

- VNC: The VNC server can be used for remote access to the LCD display on devices that have it. The service is disabled by default.
- Modbus TCP: A Modbus TCP server is running when Modbus TCP is operated in slave mode. In all other cases this service is not needed.
- KNXnet/IP: A KNXnet/IP server is running if KNX is enabled on the Ethernet port. In all other cases this service is not needed.
- RNI: This service provides the remote network interface (RNI) function. It is also used by the remote LPA feature. If these features are not needed the service can be disabled.
- logiCAD online test: This service is used by the L-logiCAD programming tool for online debugging of IEC61131 programs. It is enabled by default on L-INX devices that have the IEC61131 logic kernel. The service can be disabled.
- LIOB-IP: This service is used by the L-IOB host function to operate LIOB-IP I/O modules. This service is enabled by default on all L-INX devices. The service can be disabled.
- OPC UA: This secure service provides access to data points over the OPC UA standard. The service is disabled by default.
- SNMP: SNMP server. It provides network management information on the device used by standard IT tools. The service is disabled by default.
- Wireshark front-end: The Wireshark protocol analyzer may connect to this service and retrieve online protocol analyzer logs. The service is disabled by default.

12.5 Upgrade Key Strength

The secure services (HTTPS, SSH) rely on certificates to authenticate the device against the connecting client. This is key to prevent man-in-the-middle attacks. The device comes with pre-installed server certificates. It is recommended to upgrade the pre-installed certificate to an individual server-certificate and use stronger key length.

- Server certificate (for HTTPS, OPC UA): Follow the instructions in the LOYTEC Device User Manual [1] Section 3.2.29 Certificate Management on how to upgrade the pre-installed server certificate to a custom, self-signed or CA-signed certificate with stronger key length.
- SSH key upgrade: If SSH is enabled it is recommended to upgrade the SSH key length. Refer to the LOYTEC Device User Manual [1] Section 3.2.28 SSH Server Config on how to upgrade your RSA key to 2048 bits.

12.6 Logging and Auditing

The device contains a log file, which can be read out over FTP or the Web server. This log contains information when the device started and when crucial communication errors occur. Other information such as user log-on are not logged as they are not part of the primary services of this device.

Logged events:

- Time of the last power-on reset of the L-INX/L-GATE device.
- Time and version of the last firmware upgrade.
- Time when the device configuration has been cleared or the device was reset to factory defaults.
- Commission of the CEA-709 node/router.

- Static errors in the device and data point configuration.
- System overload situations as one-time log messages since last power-on.
- Crucial communication errors as they occur.

13 Specifications

13.1 Physical Specifications

13.1.1 LINX-102/103/112/113/202/203/212/213/215 and LGATE-902

Operating Voltage	12 – 35 VDC or 12 – 24 VAC \pm 10 %
Power Consumption	typ. 2.5 W
In rush current	up to 950 mA @ 24 VAC
Operating Temperature (ambient)	0°C to +50°C
Storage Temperature	-10°C to +60°C
Humidity (non condensing) operating	10 to 90 % RH
Humidity (non condensing) storage	10 to 90 % RH
Enclosure	Installation enclosure 107 mm wide, DIN 43 880
Environmental Protection	IP 40 (enclosure); IP 20 (screw terminals)
Installation	DIN rail mounting (EN 50 022) or wall mounting

13.1.2 LINX-12X/15X/22X, LGATE-95X

Operating Voltage	24 VDC or 24 VAC \pm 10 %
Power Consumption	typ. 2.5 W
In rush current	up to 950 mA @ 24 VAC
Operating Temperature (ambient)	0°C to +50°C
Storage Temperature	-10°C to +60°C
Humidity (non condensing) operating	10 to 90 % RH
Humidity (non condensing) storage	10 to 90 % RH
Enclosure	Installation enclosure 159 mm wide, DIN 43 880
Environmental Protection	IP 40 (enclosure); IP 20 (screw terminals)
Installation	DIN rail mounting (EN 50 022) or wall mounting

13.2 Resource Limits

13.2.1 L-INX Models

Table 8 and Table 9 specify the resource limits of the different L-INX models.

Model Limits	102/103	112/113	120/121	150/151	153	154
Total number of data points	10,000	10,000	30,000	30,000	30,000	30,000
OPC Tags	2,000	2,000	10,000	10,000	10,000	10,000
User Registers	2,000	2,000	2,000	2,000	10,000	10,000
NVs (static, dynamic)	1,000	1,000	2,000	2,000	2,000	2,000
External NVs	1,000	1,000	2,000	2,000	2,000	2,000
Alias NVs (ECS and legacy mode)	1,000	1,000	2,000	2,000	2,000	2,000
Address table entries/legacy	512/ 15	1000/ 15	1,000/ 15	1,000/ 15	1,000/ 15	1,000/ 15
LONMARK Calendar objects	1 (25 calendar patterns)					
LONMARK Scheduler objects	100 (max. AST configuration size 384KB, 64 data points per scheduler)					
LONMARK Alarm Servers	1	1	1	1	1	1
BACnet objects (analog, binary, multi-state)	n/a	n/a	n/a	1,000	2,000	1,000
BACnet client mappings	n/a	n/a	n/a	5,000	5,000	5,000
BACnet scheduler objects	n/a	n/a	n/a	100	100	100
BACnet calendar objects	n/a	n/a	n/a	25	25	25
BACnet notification classes	n/a	n/a	n/a	32	32	32
BDT max recommended	n/a	n/a	n/a	100	100	100
Foreign devices max	n/a	n/a	n/a	256	256	256
KNX Communication Objects (per interface)	250	250	1000	1000	1000	n/a
Trend Logs	256	256	512	512	512	512
Total trended data points	256	256	1000	1000	1000	1000
Total aggregated size	60MB	60MB	60MB	60MB	60MB	60MB
E-mail templates	100	100	100	100	100	100
Math objects	100	100	100	100	100	100
Alarm Logs	10	10	10	10	10	10
Modbus data points	2,000	2,000	2,000	2,000	2,000	5,000
M-Bus data points	1,000	1,000	1,000	1,000	1,000	n/a
EnOcean data points	250	250	1,000	1,000	1,000	n/a
SMI devices (per port)	16	16	16	16	16	n/a
Connections (local)	1,000	1,000	2,000	2,000	2,000	2,000
Connections (global)	250	250	250	250	250	250
L-WEB Clients (concurrent)	32	32	32	32	32	32
L-IOB Modules	8	8	24	24	24	24
LWLAN-800 AP+Mesh max clients	7	7	7	7	7	7

Table 8: Resource limits of different L-INX models

Model Limits	202/203	212/213	215	220/221
Total number of data points	10,000	10,000	10,000	30,000
OPC Tags	2,000	2,000	2,000	10,000
User Registers	2,000	2,000	2,000	2,000
NVs (static, dynamic)	n/a	n/a	1,000	n/a
External NVs	n/a	n/a	1,000	n/a
Alias NVs (ECS and legacy mode)	n/a	n/a	1,000	n/a
Address table entries/legacy	n/a	n/a	1000/15	n/a
LONMARK Calendar objects	n/a	n/a	1 (25)	n/a
LONMARK Scheduler objects	n/a	n/a	100	n/a
LONMARK Alarm Servers	n/a	n/a	1	n/a
BACnet objects (analog, binary, multi-state)	750	750	750	1,000
BACnet client mappings	750	750	750	5,000
BACnet scheduler objects	100	100	100	100
BACnet calendar objects	25	25	25	25
BACnet notification classes	32	32	32	32
BDT max recommended	100	100	100	100
Foreign devices max	256	256	256	256
KNX Communication Objects (per interface)	250	250	250	1000
Trend Logs	256	256	256	512
Total trended data points	256	256	256	1000
Total aggregated size	60MB	60MB	60MB	60MB
E-mail templates	100	100	100	100
Math objects	100	100	100	100
Alarm Logs	10	10	10	10
Modbus data points	2,000	2,000	2,000	2,000
M-Bus data points	1,000	1,000	1,000	1,000
EnOcean data points	250	250	250	1,000
SMI devices (per port)	16	16	16	16
Connections (local)	1,000	1,000	1,000	2,000
Connections (global)	250	250	250	250
L-WEB Clients (concurrent)	32	32	32	32
L-IOB Modules	8	8	8	24
LWLAN-800 AP+Mesh max clients	7	7	7	7

Table 9: Resource limits of different L-INX models (cntd.)

13.2.2 L-GATE Models

Table 10 specifies the resource limits of the different L-GATE models.

Model			
Limits	902	950/951	952
Total number of data points	10,000	30,000	30,000
OPC Tags	2,000	5,000	5,000
User Registers	1,000	2,000	2,000
NVs (static, dynamic)	1,000	2,000	2,000
External NVs	1,000	2,000	2,000
Alias NVs (ECS and legacy mode)	1,000	2,000	2,000
Address table entries/legacy	512/15	1,000/15	1,000/15
LONMARK Calendar objects	1 (25 calendar patterns)		
LONMARK Scheduler objects	100 (max. AST configuration size 384KB, 64 data points per scheduler)		
LONMARK Alarm Servers	1	1	1
BACnet objects (analog, binary, multi-state)	2,000	1,000	2,000
BACnet client mappings	750	1,000	1,000
BACnet scheduler objects	100	100	100
BACnet calendar objects	25	25	25
BACnet notification classes	32	32	32
BDT max recommended	100	100	100
Foreign devices max	256	256	256
KNX Communication Objects (per interface)	250	1000	1000
Trend Logs	256	512	512
Total trended data points	256	1,000	1,000
Total aggregated size	60MB	60MB	60MB
E-mail templates	100	100	100
Math objects	100	100	100
Alarm Logs	10	10	10
Modbus data points	250	2,000	2,000
M-Bus data points	250	1,000	1,000
EnOcean data points	250	1,000	1,000
SMI devices (per port)	16	16	16
Connections (local)	1,000	2,000	2,000
Connections (global)	250	250	250
L-WEB Clients (concurrent)	32	32	32
L-IOB Modules	n/a	n/a	n/a
LWLAN-800 AP+Mesh max clients	7	7	7

Table 10: Resource limits of different L-GATE models

13.3 Removable Media

13.3.1 LINX-12X/15X/22X, LGATE-950/951

SD Card

microSD form factor, max 8GB, standard density or SDHC (no SDXC), optionally with or without partition table, uses first primary partition

13.4 FCC Warning

This device has been tested and found to comply with limits for a Class B digital device, pursuant to Part 2 and 15 of FCC Rules. These limits are designed to provide reasonable protection against harmful interference when the equipment is operated in a commercial environment. This equipment generates and radiates radio frequency energy and, if not installed and used in accordance with the user's manual, it may cause interference in which case users will be required to correct interference at their own expenses.

13.5 CE Warning

This is a Class B product. In a domestic environment, this product may cause radio interference in which case the user may be required to take adequate measures.

14 References

- [1] LOYTEC Device User Manual 7.2, LOYTEC electronics GmbH, Document № 88086507, April 2020.
- [2] LINX Configurator User Manual 7.2, LOYTEC electronics GmbH, Document № 88086707, April 2020.
- [3] NIC User Manual 4.2, LOYTEC electronics GmbH, Document № 88067217, April 2013.
- [4] LWEB-802/803 User Manual 3.2, LOYTEC electronics GmbH, Document № 88074220, March 2019.
- [5] LWEB-900 User Manual 3.0, LOYTEC electronics GmbH, Document № 88081508, April 2019.
- [6] L-VIS User Manual 6.2, LOYTEC electronics GmbH, Document № 88068522, August 2017.
- [7] L-IOB I/O Module User Manual 7.2, LOYTEC electronics GmbH, Document № 88078513, April 2020.
- [8] L-IP User Manual 7.0, LOYTEC electronics GmbH, Document № 88065914, September 2019.
- [9] LIP-ME20x User Manual 7.2, LOYTEC electronics GmbH, Document № 88073509, April 2020.

15 Revision History

Date	Version	Author	Description
2016-03-23	6.0	STS	Re-organized User Manual structure, branched out common parts into LOYTEC Device User Manual and LINX Configurator User Manual.
2016-10-19	6.1	STS	Added new device models. Added license activation.
2017-04-24	6.2	STS	Added new device models.
2017-12-20	6.3	STS	Updated for firmware 6.3.0.
2018-05-15	6.4	STS	Updated for firmware 6.4.0. Limit changes for L-INX models.
2019-05-15	7.0	STS	Updated for firmware 7.0.0.
2020-04-30	7.2	STS	Updated for firmware 7.2.0. Removed old models LINX-100/101/110/111/200/201/210/211 and LGATE-900. Documented LWLAN-800 client limitation.