L-STAT

L-STAT™ Network Thermostat

User Manual

LOYTEC electronics GmbH



Contact

LOYTEC electronics GmbH
Blumengasse 35
1170 Vienna
AUSTRIA/EUROPE
support@loytec.com
<http://www.loytec.com>

Version 1.4

Document № 88085805

LOYTEC MAKES AND YOU RECEIVE NO WARRANTIES OR CONDITIONS,
EXPRESS, IMPLIED, STATUTORY OR IN ANY COMMUNICATION WITH YOU,
AND

LOYTEC SPECIFICALLY DISCLAIMS ANY IMPLIED WARRANTY OF
MERCHANTABILITY OR FITNESS FOR A PARTICULAR PURPOSE. THIS
PRODUCT IS NOT DESIGNED OR INTENDED FOR USE IN EQUIPMENT
INTENDED FOR SURGICAL IMPLANT INTO THE BODY OR OTHER
APPLICATIONS INTENDED TO SUPPORT OR SUSTAIN LIFE, FOR USE IN
FLIGHT CONTROL OR ENGINE CONTROL EQUIPMENT WITHIN AN
AIRCRAFT, OR FOR ANY OTHER APPLICATION IN WHICH IN THE FAILURE
OF SUCH PRODUCT COULD CREATE A SITUATION IN WHICH PERSONAL
INJURY OR DEATH MAY OCCUR. LOYTEC MAKES NO REPRESENTATION
AND OFFERS NO WARRANTY OF ANY KIND REGARDING OF ANY
THIRDPARTY COMPONENTS MENTIONED IN THIS MANUAL.

No part of this publication may be reproduced, stored in a retrieval system, or transmitted, in
any form or by any means, electronic, mechanical, photocopying, recording, or otherwise,
without the prior written permission of LOYTEC.

LC3020™, L-Chip™, L-Core™, L-DALI™, L-GATE™, L-INX™, L-IOB™,
LIOB-Connect™, LIOB-FT™, L-IP™, LPA™, L-Proxy™, L-Switch™, L-Term™,
L-VIS™, L-WEB™, L-ZIBI™, ORION™ stack and Smart Auto-Connect™ are
trademarks of LOYTEC electronics GmbH.

Contents

1	Introduction	7
1.1	Overview	7
1.2	Key Features	8
1.3	LCD Segments	9
2	What's New in L-STAT	13
2.1	New in L-STAT 1.4.0	13
2.2	New in L-STAT 1.2.3	13
2.3	New in L-STAT 1.2.0	13
2.4	New in L-STAT 1.1.0	14
3	Quick-Start Guide	15
3.1	Hardware Installation.....	15
3.2	User Interface	16
3.2.1	General Description.....	16
3.2.2	Operating Modes.....	17
3.2.3	Access Levels.....	19
3.2.4	Device Settings.....	20
3.2.5	Factory Default.....	21
3.3	Getting Started with the Configurator	22
4	Modbus	23
4.1	Introduction	23
4.2	Modbus Network.....	23
4.3	Modbus Register Usage for Value Display	24
4.4	Modbus Register Description	25
4.4.1	Data Registers	25
4.4.2	Device Settings.....	33
4.4.3	Configuration Registers.....	36
4.4.4	Model Information Registers (read only).....	52
4.4.5	Device Information Registers (read only).....	54
4.4.6	NFC Registers	55
4.4.7	Value Scaling and Stepwidth	56
5	NFC.....	57
5.1	General Description	57
5.2	Copy the L-WEB Project URL to the NFC Tag Memory	58
6	IR-Remote Control Operation	60
6.1	General Description	60

6.2	Remote Control Pairing	61
7	Firmware Update	62
7.1	Firmware Update via the Web Interface	62
7.2	Restoring Default Modbus Settings in Bootloader	63
8	Configuration Backup & Restore	64
8.1	Configuration Backup & Restore via the Web Interface	64
9	Troubleshooting	65
9.1	Technical Support	65
10	Specifications	66
10.1	Physical Specifications	66
10.2	Sensor Specifications	68
11	References	70
12	Revision History	71

Abbreviations

ASCII	American Standard Code for Information Interchange
IR	Infrared
LCD	Liquid Crystal Display
NDEF	NFC Data Exchange Format
NFC	Near Field Communication
RGB	Red, Green, Blue
URI	Uniform Resource Identifier
URL	Uniform Resource Locator

1 Introduction

1.1 Overview

The L-STAT is a network thermostat device with a modern, minimalistic look that fits any interior design. It is directly connected to a LOYTEC controller with a Modbus interface such as LIOB-AIR, L-ROC or L-INX.

Up to 16 L-STAT devices can be connected to one controller to offer control at different locations for the largest rooms. The L-STAT is equipped with a segmented LCD display featuring an RGB backlight with adjustable color, offering a neat way to make the L-STAT match the interior color concept of an office building. Eight capacitive touch buttons are used to cycle through sensor values, display parameters, and adjust setpoints. Up to four external buttons can be accessed and processed by the controller.

The L-STAT's internal sensors measure temperature, humidity, dew point, occupancy and CO₂ level. Sensor values can be displayed in SI or US units. Additionally, the date and time as well as the current level of eco-friendliness are also displayed on the LCD display. Parameters controlled by the controller's logic can be overridden on the L-STAT, such as for occupancy, air conditioning, and ventilation. A direct access mode is available to quickly adjust the most important setpoints e.g. for temperature and ventilation control.

A buzzer provides acoustic feedback for the touch buttons and can also be used to indicate alarms and error states. To prevent unauthorized modifications, two access levels (end user, system integrator) are used, which are secured via 4-digit pin codes. Device replacement, firmware upgrade, and L-STAT configuration are performed with very little effort through the controller. The L-STAT device is represented in the controller by a simple data point interface, which can be directly connected to the IEC 61131 or IEC 61499 logic application and offers all common functions for data points such as alarming, scheduling, trending, historic filters, math functions, etc.

Using an NFC tag, the L-STAT transmits the URL of an L-WEB project to mobile devices for more extensive control and administrative tasks. Last but not least, the L-STAT comes with a built-in infrared receiver for comfortable remote control.

1.2 Key Features

The different L-STAT models and their features are documented in Table 1.

Features	LSTAT-800-Gx-Lx	LSTAT-801-Gx-Lx	LSTAT-802-Gx-Lx
Modbus RTU Slave	✓	✓	✓
NFC Tag	✓	✓	✓
Buzzer	✓	✓	✓
Internal Temperature Sensor	✓	✓	✓
Internal Relative Humidity Sensor	✓	✓	✓
3 x Digital Inputs 1 x Analog Input	✓	✓	✓
Infrared Receiver	✓	✓	✓
Occupancy Sensor	-	✓	✓
CO ₂ Sensor	-	-	✓

Table 1: Key Features

Not only the model type but also the enclosure color as well as the touch button layout is defined with the order code. See Table 2 for possible order codes.





Nomenclature of Order Codes	
Model Type 80x: 800, 801, 802 (see Table 1)	
Enclosure Gx: G1 – silver G2 – black G3 – white	
Layout Lx: L1 –	
L2 –	
L3 –	
L4 –	
L5 –	
L6 –	

Table 2: Possible Order Codes

1.3 LCD Segments

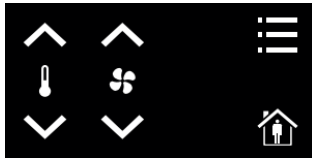
The following Figure 1 shows the LCD of the L-STAT with all possible segments.

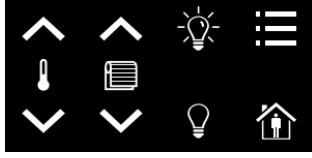
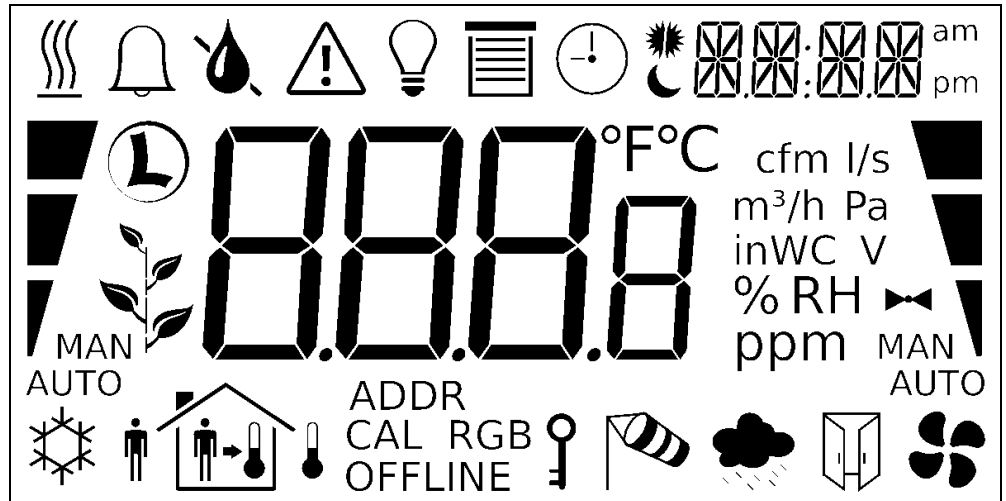











































Figure 1: LCD Segments available on L-STAT

The following Table gives an overview of all available segments of the L-STAT LCD with its defined names. The Table also shows which symbols are directly accessible via Modbus registers (see Table 12 on Page 29).

Segment	Name	Description	Direct Access
	heat	Heating symbol	✓
	alarm_bell	Alarm bell symbol	✓
	drop	Drop symbol	✓
	drop_not	Cross out for drop symbol	✓
	alarm	Alarm symbol	✓
	light	Light bulb symbol	✓
	blinds	Sun blinds symbol	✓

Segment	Name	Description	Direct Access
	clock	Clock symbol	✓
	sun_left	Left half of sun symbol	✓
	sun_right	Right half of sun symbol	✓
	moon	Moon symbol	✓
	colon	The colon symbol of the secondary display will only be available if the secondary_display_direct_access_string register at address 200 (see Table 23 Page 37) is not empty.	✓
	secondary_display	The secondary display is used to show time, date and/or a short text depending on the semantic meaning of a display value or set point. It can also be directly accessed via the Modbus register: secondary_display_direct_access_string (see Table 23 on Page 37).	✓
am pm	am_pm_symbols	These symbols are not directly accessible but are shown along with the time when 12h time format has been selected.	-
	cool	Cooling symbol	✓
	man_out	Man outside the house (no occupancy)	✓
	man_in	Man inside the house (occupancy)	✓
	arrow	Arrow symbol (to represent a set point)	✓
	temp_in	Temperature inside	✓
	temp_out	Temperature outside	✓
	house	House symbol	✓
ADDR CAL RGB OFFLINE	text_symbols	The text symbols are not accessible via Modbus but are shown at certain modes or events.	-
	key	The key symbol is primarily used to show that a set point is pincode protected but it can also be accessed via the symbol direct access registers.	✓

Segment	Name	Description	Direct Access
	wind	Wind alarm symbol	✓
	rain	Rain alarm symbol	✓
	window	Window open alarm symbol	✓
	fan	Fan symbol	✓
	valve	Valve symbol	✓
	logo	Loytec logo symbol	✓
	green_leaf_3	The green leaf symbols can be used to display the level of eco-friendliness or to visualize environmental conditions.	✓
	green_leaf_2		✓
	green_leaf_1		✓
	green_leaf_0		✓
	bar_left_2	The left bar graph symbols can be used to display a heating or cooling stage in automatic or manual mode.	✓
	bar_left_1		✓
	bar_left_0		✓
	manual_left		✓
	auto_left		✓
	bar_right_2		The right bar graph symbols can be used to display a fan stage or valve position in automatic or manual mode.
	bar_right_1	✓	
	bar_right_0	✓	
	manual_right	✓	
	auto_right	✓	

Segment	Name	Description	Direct Access
	main_display	The main display is primarily used to show certain values. It is not accessible directly.	-
°F	unit_F	All unit symbols are not directly accessible but are displayed along with a display value or set point if the unit is set in the corresponding configuration register. See Table 28 on Page 42 for display value configuration and Table 29 on Page 44 for set point configuration.	-
°C	unit_C		-
cfm	unit_cfm		-
l/s	unit_l/s		-
m ³ /h	unit_m ³ /h		-
Pa	unit_Pa		-
inWC	unit_inWC		-
V	unit_V		-
%	unit_%		-
% RH	unit_%RH		-
ppm	unit_ppm		-

Table 3: LCD Segments Overview

2 What's New in L-STAT

2.1 New in L-STAT 1.4.0

This section describes the major changes and new features. For a full list of changes refer to the Readme file.

Loading Factory Default Values in Device Settings Menu

Factory default values can now be loaded via the device settings menu. For further information see Section 3.2.5 on Page 21.

2.2 New in L-STAT 1.2.3

This section describes the major changes and new features. For a full list of changes refer to the Readme file.

Display Auto Shuffle Mode

At the user_interface_settings register at address 183 (see Table 20 on Page 35) the DAS flag was added which activates the display auto shuffle mode, where each display value or set point is shown for 5 seconds within a cycle.

2.3 New in L-STAT 1.2.0

This section describes the major changes and new features. For a full list of changes refer to the Readme file.

Configuration Backup & Restore

The new firmware supports the backup and restore of Modbus registers used for configuring the device. Please see Chapter 8 for further information.

Secondary_display_direct_access_string_volatile Flag

An additional flag was added at the configuration flags register at address 192 (see Table 22 on Page 36) for setting the content of the secondary_display_direct_access_string register volatile.

2.4 New in L-STAT 1.1.0

This section describes the major changes and new features. For a full list of changes refer to the Readme file.

Cleaning Function

This is a special mode for cleaning the surface of the device where touch-buttons are disabled for a certain amount of time. Please see Section 3.2.2 for further information.

External Button Inputs support Switches

With this firmware the external button inputs are supporting push-buttons and switches too.

3 Quick-Start Guide

3.1 Hardware Installation

Please refer to the L-STAT installation sheet for further information on dimensions, mounting and wiring.

Figure 2 shows the back view of the device with the connection terminals for Modbus, 24 V DC-Supply and external buttons. The four external buttons share a common GND connection which is internally connected to the negative 24 V input terminal.

The external button terminal EB3 is also capable of sensing a NTC-10k temperature sensor. The temperature value of the sensor will be provided on Modbus register address 49 (see Table 10 on Page 27). The cable length for connecting the temperature sensor must not exceed 150m for 0.5mm² or 70m for 0.25mm² to guarantee a temperature error less than 0.1% at 25°C.

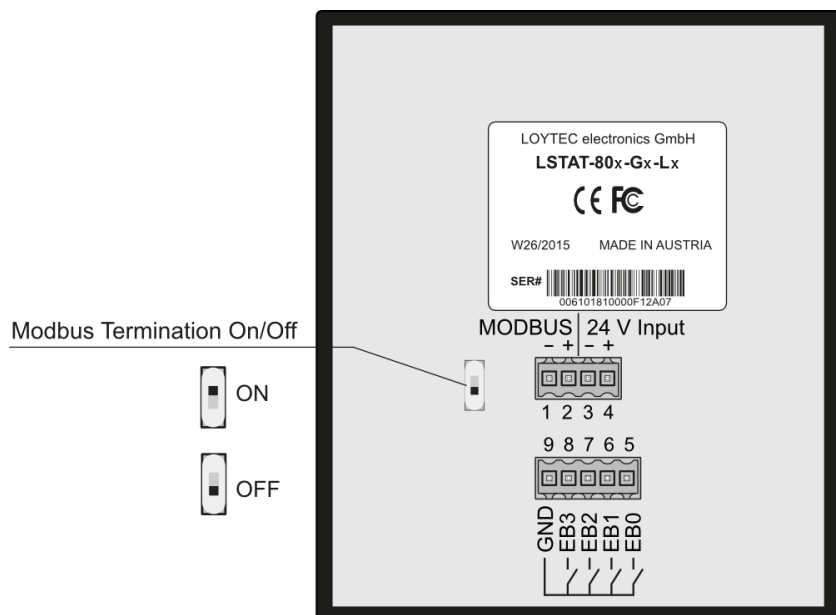

Figure 2: Back View LSTAT-80x-Gx-Lx

3.2 User Interface

3.2.1 General Description

The user interface consists of the LCD for displaying any desired value and up to eight touch buttons which are used to adjust set points and change settings. Additionally up to four external push-buttons can be connected to the device.

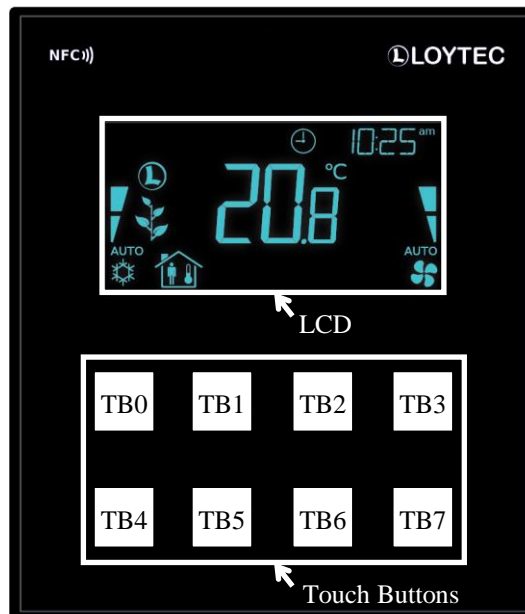







Figure 3: Front View LSTAT-80x-Gx-Lx

Each button can be configured individually via a Modbus register for its function (see Table 24 on Page 38). The following listing gives you an overview which functionality can be associated with the buttons.

UP	DOWN	change set point or device setting in EDIT-mode directly access a set point in DISPLAY-mode
		
ON	OFF	no specific function, the button state can be requested to control lighting
		
OCCUPANCY		no specific function, the button state can be requested to set occupancy state
MENU		short press <3s: cycle through display values, set points or device settings long press ~3s: switch between DISPLAY-mode and EDIT-mode long press >6s: switch to CLEANING-mode

3.2.2 Operating Modes

In Figure 4 the operating modes of L-STAT are depicted. Each operating mode gives access to certain Modbus registers that can either be viewed or edited depending on the mode. The following data is available on L-STAT:

- **display values:** Are used to visualize data provided by the Modbus master or values of internal sensors. It is viewed in DISPLAY-mode. For the display value registers see Table 11 on Page 28 and Table 28 on Page 42 for the corresponding display value configuration.
- **set points:** Are used to visualize data that is provided by the Modbus master and that can be edited by the user. It is shown in DISPLAY-mode and it can be edited in EDIT-mode. For the set point registers see Table 32 on Page 48 and Table 29 on Page 44 for set point configuration. The range in which a set point can be altered is defined by minimum and maximum values that have to be written by the Modbus master. Please refer to Table 33 on Page 49 and Table 34 on Page 50.
- **device settings:** These values define some basic settings of the device itself. Please refer to Table 5 on Page 20 for a listing of all device settings and to Table 18, Table 19 and Table 20 on Page 33 f. for the corresponding Modbus registers. Device Settings can only be edited by the system administrator in EDIT-mode.
- **offset values:** Are used to add a certain offset to a display value. This functionality can be used to calibrate sensor values. Offset values can be edited by the system administrator in CALIBRATION-mode directly at the device or over Modbus. Please see Table 35 on Page 51 for the offset value register.

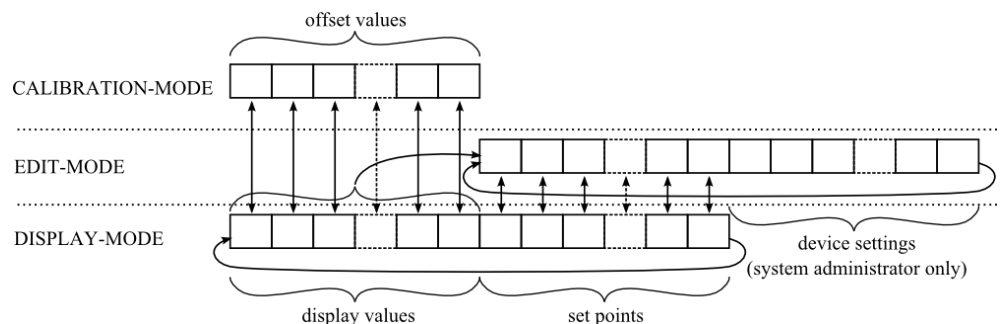

Figure 4: Operating Modes of L-STAT

When the device powers up, it enters DISPLAY-mode and it will display the first display value. When pressing the MENU-button the next value will be shown. First all active display values and then all active set points are displayed. After the last set point, the display will show the first display value again.

EDIT-mode is entered by pressing the MENU-button for more than 3 seconds. To enter EDIT-mode as system administrator two additionally defined buttons (TB0 and TB4) need to be pressed along with the MENU-button for more than 3 seconds. Also in EDIT-Mode a short press on the MENU-button is used to go to the next value. Any other button that has no specific function can be used in EDIT-mode to cycle the values in the opposite direction. EDIT-mode is left when pressing the MENU-button for more than 3 second.

The system administrator will also be able to view and edit the device settings.

CALIBRATION-mode will be entered for any display value when pressing one UP- and one DOWN-button simultaneously for more than 3 seconds to adjust the offset. This mode is secured by the system administrator password. CALIBRATION-mode is left when pressing the MENU-button for more than 3 second or after a timeout of 1 minute.

An overview of all possible operating modes is given in Table 4 below. The operating mode can also be defined by the Modbus master by writing the user interface direct access register (see Table 13 on Page 29).

Order of L-STAT Operating Modes	Description
0 DISPLAY-mode / display values	Display values are shown.
1 DISPLAY-mode / set points	Set points are shown.
2 EDIT-mode / set points	Set points can be edited.
3 EDIT-mode / device settings	Device settings can be edited. This mode is only accessible for the system administrator.
4 CALIBRATION-mode / offset values	Offset values can be edited
5 PINCODE-ENTRY / end user	The pincode for the end user has to be entered to show and/or edit the requested value.
6 PINCODE-ENTRY / system administrator	The pincode for the system administrator has to be entered to show and/or edit the requested value.
7 DIRECT_ACCESS-mode / set points	A defined set point can be accessed and edited without entering EDIT-mode. It can be entered by pressing a defined button (see Table 24 on Page 38). In contrast to EDIT-mode only predefined set points can be edited. The DIRECT_ACCESS-mode can be left by pressing any button that has no direct access capability.
10 CLEANING-mode	This mode is used to clean the surface of the device without any response of the touch buttons and hence any unwanted changes. This mode is entered by pressing the MENU-button for at least 6 seconds. After 10 seconds with no interaction the device will switch back to DISPLAY-mode automatically.

Table 4: Operating Modes

3.2.3 Access Levels

The L-STAT has two access levels (end user & system administrator) with configurable rights to display and edit values. Each access level is secured by a four digit pincode that will be requested if EDIT-mode or DIRECT_ACCESS-mode is entered and the desired value is pincode protected.

Per default the pincode for end user and system administrator access level is disabled (0000). Otherwise the pincode can be entered as described in Figure 5.

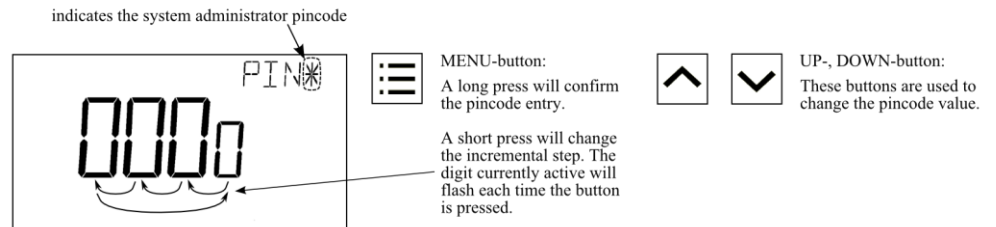

Figure 5: Pincode Entry

3.2.4 Device Settings

The following Table gives an overview of the device settings accessible through the button interface as well as via Modbus. For the corresponding Modbus registers please refer to Table 18, Table 19 and Table 20 on Page 33 and following.

Device Setting	Possible Values	Default	Your Setting
Modbus Parity	Odd / Even / None	None	
Modbus Baudrate	1.2kB / 2.4kB / 4.8kB / 9.6kB / 19.2kB / 38.4kB / 57.6kB / 115.2kB	57,6kB	
Modbus Address	1 - 247	1	
Pincode System Administrator	0000 – 9999 (if 0000 the pincode is disabled)	0000	
Pincode End User	0000 – 9999 (if 0000 the pincode is disabled)	0000	
Color Setting LCD Backlight Red	0% - 100%	100%	
Color Setting LCD Backlight Green	0% - 100%	100%	
Color Setting LCD Backlight Blue	0% - 100%	100%	
Brightness LCD Backlight	0% - 100%	100%	
LCD Contrast	0% - 100%	100%	
LCD Color Scheme	0 – user (as defined above) 1 – white 2 – red 3 – green 4 – blue 5 – orange 6 – magenta 7 – cyan	0	
Time Format	24h / 12h	24h	
Show Date	on / off	off	
Show Time	on / off	off	
Acoustic Feedback (for Touch Buttons)	on / off	on	
Goto First Display Value (the first display value will be displayed after 1 minute without interaction)	on / off	on	
Display Auto Shuffle	on / off	off	
Display Auto Dim (lcd brightness will be dimmed after 2 minutes with no interaction)	off / 50% / 10% / 0% / OCC* * built-in occupancy sensor activates display	off	
Unit System	SI / US	SI	
Device Restart	off – if a DOWN-button is pressed the device will be rebooted manually	-	
Load Factory Defaults	see Section 3.2.5 on Page 21	-	

Table 5: Device Settings

3.2.5 Factory Default

The factory default configuration for display values and set points depends on the specific L-STAT model. The following Table shows the factory default values for each model. See Table 28 on Page 42 for display value configuration and Table 29 on Page 44 for set point configuration.

	LSTAT-800-Gx-Lx	LSTAT-801-Gx-Lx	LSTAT-802-Gx-Lx
display_value_0	Internal Temperature	Internal Temperature	Internal Temperature
display_value_1	Relative Humidity	Relative Humidity	Relative Humidity
display_value_2	Dew Point	Dew Point	Dew Point
display_value_3	-	-	CO ₂ Level
display_value_4	Modbus Voltage	Modbus Voltage	Modbus Voltage
display_value_5	External Temperature	External Temperature	External Temperature
display_value_6 to display_value_15	-	-	-
set_point_0	Internal Temperature Set Point	Internal Temperature Set Point	Internal Temperature Set Point
set_point_1	Fan Stage	Fan Stage	Fan Stage
set_point_2 to set_point_15	-	-	-

Table 6: Factory Default for L-STAT Models

The factory default values can be loaded manually via the device settings menu. The function is located at the last position of the menu. The secondary display will show which button has to be pressed as depicted in Figure 6. After all buttons have been pressed in the right order the factory defaults will be loaded. Therefore the device will reboot. By pressing the MENU button instead of UP or DOWN during the sequence the process can be aborted.

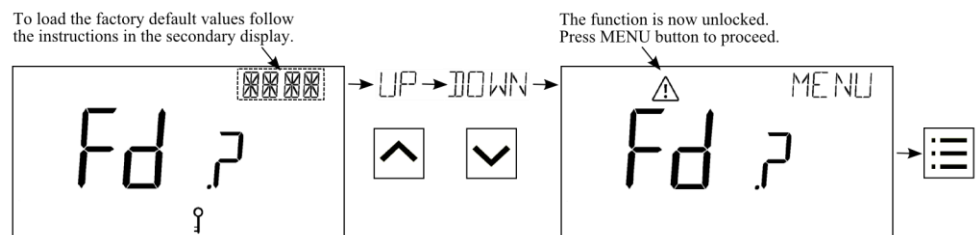

Figure 6: Loading the factory default values

3.3 Getting Started with the Configurator

A Modbus Template for the L-INX configurator with all available datapoints can be downloaded from the Libraries/Templates Download section on the LOYTEC website: <https://www.loytec.com/support/download>

For further information on using the L-INX configurator for Modbus devices please refer to the L-INX Configurator User Manual [1].

Please refer to Chapter 4 for a listing of all available Modbus Registers.

4 Modbus

4.1 Introduction

The L-STAT operates as a Modbus slave in Modbus RTU mode. The default baudrate is set to 57600, the default parity is set to 'none' and the default address is set to 1. The communication with a Modbus master device will work with Modbus function code 0x03 (Read Holding Registers) and Modbus function code 0x06 (Preset Single Register). Section 4.4 shows all available Modbus registers.

4.2 Modbus Network

Figure 7 illustrates a typical Modbus network setup with a linear bus topology used to connect several slave devices to a master device. The transmission line has to be terminated at both ends. At the master device this can be done by connecting an L-Term (LT-04) device. Each L-STAT slave device is equipped with a built-in 120Ω termination resistor. Set the termination switch to OFF except on the last device on the bus where the termination switch must be turned ON. Per default each device has the Modbus address set to 1. Because each address can only be used once it has to be configured at the device settings in EDIT-mode. For further information please see Section 3.2.

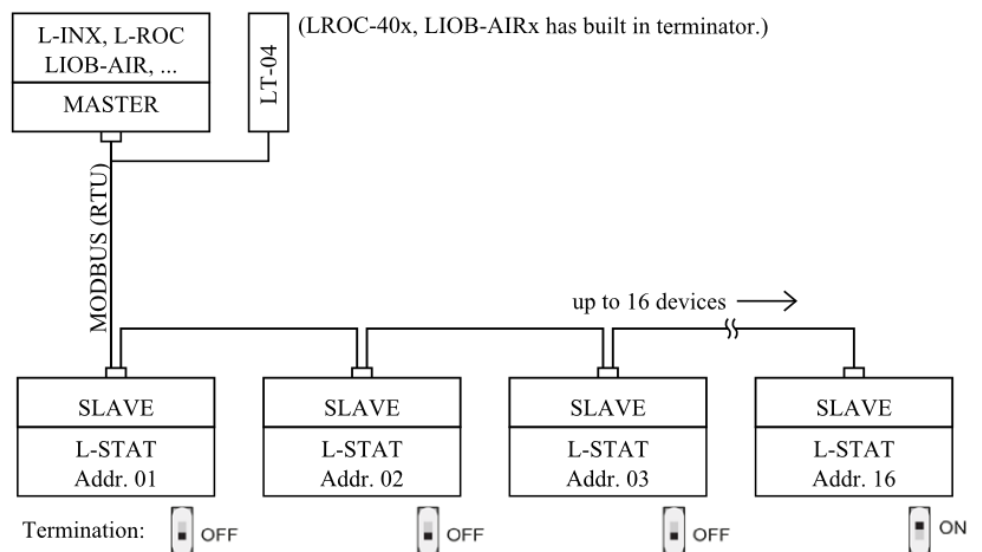

Figure 7: Modbus Network

4.3 Modbus Register Usage for Value Display

The following Figure 8 shows, which Modbus registers have influence on a displayed value, unit, text on the secondary display or symbols. Depending on settings in configuration registers different combinations are possible to achieve the desired result.

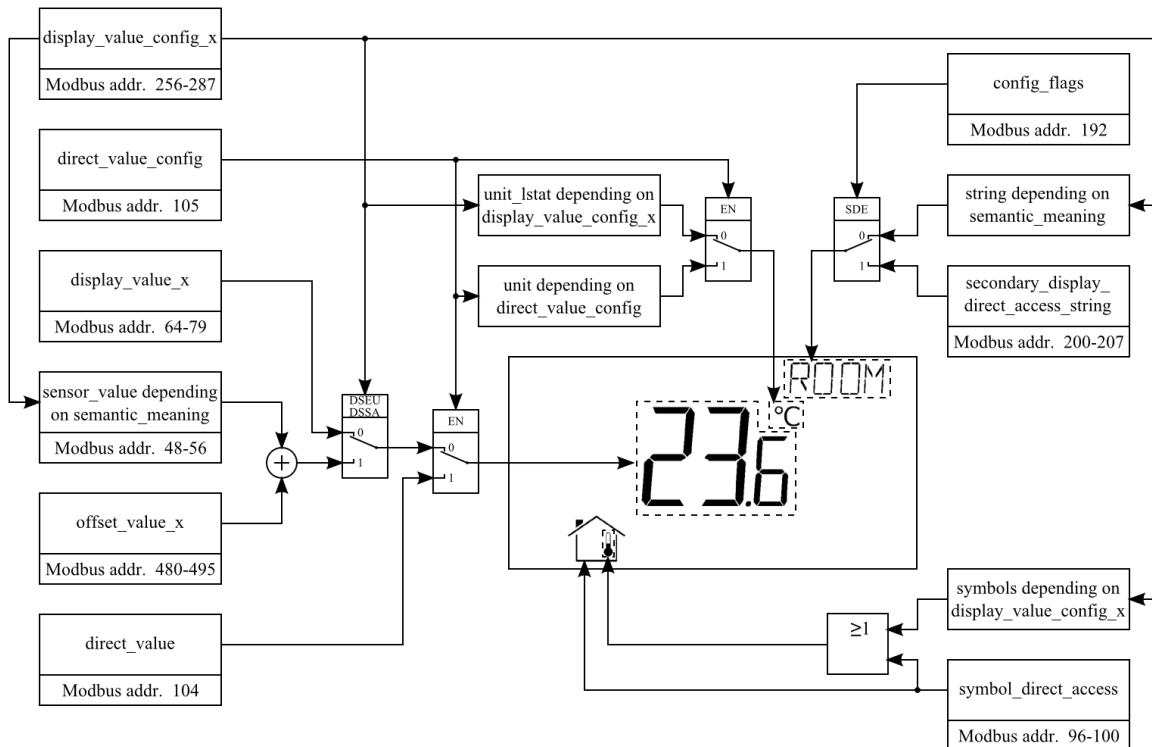

Figure 8: Modbus Register Usage for Value Display

4.4 Modbus Register Description

In the following sections the L-STAT Modbus registers are described. Abbreviations are explained at the end of each table. 'R' indicates that this value is not used by now and that it is reserved for future use. Square brackets '[']' indicate that this is the initial value. Numbers with the prefix '0x' are hexadecimal values. Values with no prefix indicate decimal values.

4.4.1 Data Registers

These registers contain data that is changing frequently. This data is not stored persistent in the L-STAT device and will be lost after a reboot.

Register Name	Register Address	Bit Position															
		15	14	13	12	11	10	9	8	7	6	5	4	3	2	1	0
present_state	0 0x0000	R [0]	R [0]	R [0]	Occu [0]												
short_pressed	1 0x0001	IRC [0]	NFC [0]	R [0]	Occu [0]	EB3 [0]	EB2 [0]	EB1 [0]	EB0 [0]	TB7 [0]	TB6 [0]	TB5 [0]	TB4 [0]	TB3 [0]	TB2 [0]	TB1 [0]	TB0 [0]
long_pressed	2 0x0002	FD [1]	ERR [0]	DOC [0]	SPC [0]												

The present_state register always represents the actual state of the buttons and the occupancy sensor.

The short_pressed and long_pressed states will remain set until the flags are cleared by the Modbus master by writing a logical '1' to the specific flag, except the occupancy flag that is cleared automatically after the occupancy_timeout has expired. The long_pressed state of a button will remain set as long as the button is pressed.

Bits 0-11 indicate the states of the buttons (**TBx**-touch button, **EBx**-external button)

Occu: occupancy flag, defines if occupancy is detected by built-in occupancy sensor (applies to LSTAT-801-Gx-Lx and LSTAT-802-Gx-Lx)

NFC: NFC flag, is set if an NFC field was detected. This gives the information that a user is reading the NFC tag memory with an NFC enabled mobile device. For more information see Chapter 5.

IRC: infrared remote control flag, is set when an infrared remote control code was received. The received code can be read via the ir_remote_control_command register at register address 32 (see Table 9 on Page 27).

SPC: Set point changed flag, is set when a set point was changed on the L-STAT. Each set point has an individual change flag at register address 3 (see Table 8 on Page 26).

DOC: device setting or offset value changed flag, is set when a device setting or offset value was changed on the L-STAT. The specific change flags can be read via the registers at address 4 and 5 (see Table 8 on Page 26).

ERR: error flag, is set when an internal error has occurred.

FD: factory default (unconfigured) flag, is set when the device has booted with factory default settings.

① Button states and flags can have the following binary values:
 1 – pressed, set
 0 – released, cleared

① The present_state register is only updated in DISPLAY- and DIRECT_ACCESS-mode!
 (For a list of possible modes see Table 4 on Page 18)

Table 7: Button States and Flags

Register Name	Register Address	Bit Position															
		15	14	13	12	11	10	9	8	7	6	5	4	3	2	1	0
change_flags_set_points	3 0x0003	SP15 [0]	SP14 [0]	SP13 [0]	SP12 [0]	SP11 [0]	SP10 [0]	SP9 [0]	SP8 [0]	SP7 [0]	SP6 [0]	SP5 [0]	SP4 [0]	SP3 [0]	SP2 [0]	SP1 [0]	SP0 [0]
change_flags_device_settings	4 0x0004	R [0]	R [0]	R [0]	R [0]	R [0]	R [0]	R [0]	DS8 [0]	DS7 [0]	DS6 [0]	DS5 [0]	DS4 [0]	DS3 [0]	DS2 [0]	DS1 [0]	DS0 [0]
change_flags_offset_values	5 0x0005	OV15 [0]	OV14 [0]	OV13 [0]	OV12 [0]	OV11 [0]	OV10 [0]	OV9 [0]	OV8 [0]	OV7 [0]	OV6 [0]	OV5 [0]	OV4 [0]	OV3 [0]	OV2 [0]	OV1 [0]	OV0 [0]
<p>The change flag register states will remain true until the flags are cleared by the Modbus master by writing a logical '1' to the specific flag.</p> <p>SP0 to SP15: change flags for set_point_0 to set_point_15 (see Table 32 on Page 48)</p> <p>DS0: change flag for modbus_parameter on register address 176 (see Table 18 on Page 33)</p> <p>DS1: change flag for pincode_system_administrator on register address 177 (see Table 19 on Page 33)</p> <p>DS2: change flag for pincode_end_user on register address 178 (see Table 19 on Page 33)</p> <p>DS3: change flag for lcd_color_red on register address 179 (see Table 20 on Page 35)</p> <p>DS4: change flag for lcd_color_green on register address 180 (see Table 20 on Page 35)</p> <p>DS5: change flag for lcd_color_blue on register address 181 (see Table 20 on Page 35)</p> <p>DS6: change flag for lcd_brightness_contrast on register address 182 (see Table 20 on Page 35)</p> <p>DS7: change flag for user_interface_settings on register address 183 (see Table 20 on Page 35)</p> <p>DS8: change flag for display_unit on register address 192 (see Table 22 on Page 36)</p> <p>OV0 to OV15: change flags for offset_value_0 to offset_value_15 (see Table 35 on Page 51)</p> <p>① Change flags can have the following binary values: 1 – true 0 – false</p> <p>① If a set point, device setting or offset value is changed by the user the corresponding flag will be set and it has to be cleared by the Modbus master.</p>																	

Table 8: Change Flags

Register Name	Register Address	Bit Position															
		15	14	13	12	11	10	9	8	7	6	5	4	3	2	1	0
ir_remote_control_command	32 0x0020	button_code [0x00]								remote_id [0x00]							
<p>This register provides the button_code and remote_id of a valid command received via the infrared receiver. See Chapter 6 for detailed information.</p> <p>① Whenever a command was received the ir_remote_control_command register is updated and the IRC flag of the short_pressed register at address 1 is set (see Table 7 on Page 26).</p>																	

Table 9: IR Remote Control Command

The following Table gives an overview of the internal sensor values. These registers can be read over Modbus and can be used as source for a display value if configured. As described in Section 3.2.2 on Page 17 there are up to 16 display values used to visualize data. Each display value has two 16 bit configuration registers to specify the values displayed. Display values (register address 64 to 79) are read- and writable over Modbus.

Register Name	Register Address	Bit Position															
		15	14	13	12	11	10	9	8	7	6	5	4	3	2	1	0
sensor_value_0	48 0x0030	internal temperature															
sensor_value_1	49 0x0031	external temperature															
sensor_value_2	50 0x0032	relative humidity															
sensor_value_3	51 0x0033	dew point															
sensor_value_4	52 0x0034	reserved															
sensor_value_5	53 0x0035	amount CO ₂ (applies only to LSTAT-802-Gx-Lx)															
sensor_value_6	54 0x0036	L-STAT supply voltage															
sensor_value_7	55 0x0037	L-STAT CPU temperature															
sensor_value_8	56 0x0038	L-STAT CPU voltage															
		<p>① A sensor value can be used as source for a display value. Therefore the DSSA or DSEU bit as well as the semantic meaning at the corresponding display value configuration at address 256 to 286 has to be set (see Table 28 on Page 42). If the DSSA or DSEU bit is set this specifies that a sensor value is used instead of a display value. The semantic meaning specifies which sensor value is used as source for displaying. For an overview on this topic please see Figure 8 on Page 24.</p> <p>② Sensor_value_0, sensor_value_1 and sensor_value_3 are 16 Bit signed values. All other sensor values are defined as 16 Bit unsigned since there are no negative values to expect. The values are scaled as described in Table 39 at Page 56.</p>															

Table 10: Sensor Values

If an external temperature sensor is connected to the EB3 terminal and GND the value of this sensor will be provided as sensor_value_1. It is advised but not necessarily required to disable the button function at the button configuration register at address 227 (Table 25 at Page 39) when used as temperature sensor input.

Register Name	Register Address	Bit Position															
		15	14	13	12	11	10	9	8	7	6	5	4	3	2	1	0
display_value_0	64 0x0040	[0x0000]															
display_value_1	65 0x0041	[0x0000]															
display_value_2	66 0x0042	[0x0000]															
display_value_3	67 0x0043	[0x0000]															
display_value_4	68 0x0044	[0x0000]															
display_value_5	69 0x0045	[0x0000]															
display_value_6	70 0x0046	[0x0000]															
display_value_7	71 0x0047	[0x0000]															
display_value_8	72 0x0048	[0x0000]															
display_value_9	73 0x0049	[0x0000]															
display_value_10	74 0x004A	[0x0000]															
display_value_11	75 0x004B	[0x0000]															
display_value_12	76 0x004C	[0x0000]															
display_value_13	77 0x004D	[0x0000]															
display_value_14	78 0x004E	[0x0000]															
display_value_15	79 0x004F	[0x0000]															
		<p>① The DSSA or DSEU bit at the corresponding display value configuration at address 256 to 286 has to be cleared to display the content of a display value register (see Table 28 on Page 42). If the DSSA or DSEU bit is cleared this specifies that a display value is used instead of a sensor value. The semantic meaning specifies which text is displayed along with the specific display value. For an overview on this topic please see Figure 8 on Page 24.</p> <p>② All registers are 16 Bit signed values. Depending on the modbus_unit specified with the corresponding display value configuration register at address 256 to 287 (Table 28 at Page 42) the value needs to be scaled as described in Table 39 at Page 56 to achieve the desired result.</p>															

Table 11: Display Values

Register Name	Register Address	Bit Position															
		15	14	13	12	11	10	9	8	7	6	5	4	3	2	1	0
symbol_direct_access_0	96 0x0060																
symbol_direct_access_1	97 0x0061																
symbol_direct_access_2	98 0x0062																
symbol_direct_access_3	99 0x0063																
symbol_direct_access_4	100 0x0064																

Symbols of the LCD can be directly set by writing these registers. For an overview of all LCD segments please see Table 3 on Page 12.

2 bits are reserved per symbol indicating the state that can have the following values:

- 00 – disabled, symbol is not visible
- 01 – enabled, symbol is visible
- 10 – blinking slow (1Hz)
- 11 – blinking fast (2Hz)

① For the house symbol the initial value is set to '01' per default. The initial value of the other symbols is '00'.

① The colon symbol of the secondary display will only be available if the secondary_display_direct_access_string register at address 200 (see Table 23 Page 37) is not empty.

Table 12: Symbol Direct Access

Register Name	Register Address	Bit Position															
		15	14	13	12	11	10	9	8	7	6	5	4	3	2	1	0
user_interface_direct_access	101 0x0065	EU/SA [0]	ui_mode [0x00]						ui_index [0x00]								

This register can be read to get information of which value is currently displayed. It can also be written to determine the displayed value.

- EU/SA:** defines the current access level (0 – end user, 1 – system administrator)
- ui_mode:** defines the user interface mode the device is currently operating in.
For a listing of all L-STAT operating modes see Table 4 on Page 18.
- ui_index:** defines the index within each mode of the value currently displayed.

Please see the following examples:

- 0x0001 – This means that display_value_1 is currently displayed in DISPLAY-mode for the end user.
- 0x8200 – This means that set_point_0 is currently edited by the system administrator in EDIT-mode.

Table 13: User Interface Direct Access

Register Name	Register Address	Bit Position																																													
		15	14	13	12	11	10	9	8	7	6	5	4	3	2	1	0																														
buzzer_direct_access_0	102 0x0066	BE [0]	R [0]	R [0]	R [0]	R [0]	R [0]	R [0]	R [0]	buzzer_duration [0x00]																																					
buzzer_direct_access_1	103 0x0067	buzzer_mode [0x00]							buzzer_tone [0x00]																																						
<p>These registers are used to provide direct access of the piezo buzzer primarily used to give acoustic feedback for the touch buttons.</p> <p>BE: buzzer enable bit (1 – enabled, 0 – disabled)</p> <p>buzzer_duration: 0x00 infinite, 0x01 - 0xFF duration in seconds</p> <p>buzzer_mode: defines specific alarm sound patterns</p> <table border="0"> <thead> <tr> <th>mode:</th> <th>description:</th> <th>⇐ 1s pattern ⇒</th> </tr> </thead> <tbody> <tr> <td>0</td> <td>continuous</td> <td></td> </tr> <tr> <td>1</td> <td>alarm 1</td> <td></td> </tr> <tr> <td>2</td> <td>alarm 2</td> <td></td> </tr> <tr> <td>3</td> <td>alarm 3</td> <td></td> </tr> <tr> <td>4</td> <td>alarm 4</td> <td></td> </tr> <tr> <td>5</td> <td>alarm 5</td> <td></td> </tr> <tr> <td>6</td> <td>alarm 6</td> <td></td> </tr> <tr> <td>7</td> <td>alarm 7</td> <td></td> </tr> <tr> <td>8</td> <td>alarm 8</td> <td></td> </tr> </tbody> </table> <p>buzzer_tone: 0x00 - 100 Hz, 0xFF - 1375 Hz (step-width = 5 Hz)</p>																		mode:	description:	⇐ 1s pattern ⇒	0	continuous		1	alarm 1		2	alarm 2		3	alarm 3		4	alarm 4		5	alarm 5		6	alarm 6		7	alarm 7		8	alarm 8	
mode:	description:	⇐ 1s pattern ⇒																																													
0	continuous																																														
1	alarm 1																																														
2	alarm 2																																														
3	alarm 3																																														
4	alarm 4																																														
5	alarm 5																																														
6	alarm 6																																														
7	alarm 7																																														
8	alarm 8																																														

Table 14: Buzzer Direct Access





Register Name	Register Address	Bit Position													
		15	14	13	12	11	10	9	8	7	6	5	4	3	2
direct_value	104 0x0068	[0x0000]													
direct_value_config	105 0x0069	EN [0]	R [0]	R [0]	R [0]	R [0]	R [0]	R [0]	R [0]	R [0]	R [0]	unit [0x0]		exp [00]	
<p>These registers are used to display specific values instead of display_values or set_points. For an overview on how to setup the configuration please refer to Figure 8 on Page 24.</p> <p>direct_value: 16 bit signed integer to be displayed</p> <p>EN: direct value enable bit (1 – enabled, 0 – disabled)</p> <p>unit: defines a unit symbol to be displayed, following values are possible:</p> <p style="text-align: center;">0x0 0x1 0x2 0x3 0x4 0x5 0x6 0x7 0x8 0x9 0xA 0xB no °C °F cfm l/s m³/h Pa inWC V % %RH ppm unit</p> <p>exp: exponent, defines the number of decimal places:</p> <p style="text-align: center;">00 – no decimal point </p> <p style="text-align: center;">01 – one decimal place </p> <p style="text-align: center;">10 – two decimal places </p> <p style="text-align: center;">11 – three decimal places </p> <p>ⓘ If disabled, the last viewed value will be visible again as defined with the user_interface_direct_access register at address 101 (Table 13 on Page 29).</p>															

Table 15: Direct Value

Register Name	Register Address	Bit Position													
		15	14	13	12	11	10	9	8	7	6	5	4	3	2
system_time	112 0x0070	system_time_0 [0x0000]													
	113 0x0071	system_time_1 [0x0000]													
<p>system_time represent a 32 bit timestamp in seconds since JAN-01-1970. The timestamp has to be initially set by the Modbus master because the device has no back-up battery and so it would start at 0 (00:00:00 JAN-01-1970) after a reboot. The timestamp is incremented by the L-STAT device but anyway it has to be set by the master at defined intervals to prevent time offsets. The timestamp is compatible with the L-INX system time register.</p>															

Table 16: System Time

Register Name	Register Address	Bit Position															
		15	14	13	12	11	10	9	8	7	6	5	4	3	2	1	0
modbus_time_cleared	128 0x0080	modbus_time_cleared_0 [0x0000]															
	129 0x0081	modbus_time_cleared_1 [0x0000]															
modbus_rx_packets	130 0x0082	modbus_rx_packets_0 [0x0000]															
	131 0x0083	modbus_rx_packets_1 [0x0000]															
modbus_rx_bytes	132 0x0084	modbus_rx_bytes_0 [0x0000]															
	133 0x0085	modbus_rx_bytes_1 [0x0000]															
modbus_tx_packets	134 0x0086	modbus_tx_packets_0 [0x0000]															
	135 0x0087	modbus_tx_packets_1 [0x0000]															
modbus_tx_bytes	136 0x0088	modbus_tx_bytes_0 [0x0000]															
	137 0x0089	modbus_tx_bytes_1 [0x0000]															
modbus_timeout_errors	138 0x008A	modbus_timeout_errors_0 [0x0000]															
	139 0x008B	modbus_timeout_errors_1 [0x0000]															
modbus_checksum_errors	140 0x008C	modbus_checksum_errors_0 [0x0000]															
	141 0x008D	modbus_checksum_errors_1 [0x0000]															
<p>modbus_time_cleared_0 and modbus_time_cleared_1 represent a 32 bit timestamp in seconds since JAN-01-1970 that is set by the L-STAT device after the statistics have been cleared by the master device.</p> <p>All other values are 32 bit counters incremented by the L-STAT device. These values are not permanently stored at the L-STAT and will be lost after a reboot.</p> <p>① The statistics can be cleared by setting the MSC bit at the config_flags register at address 192 (see Table 22 on Page 36).</p>																	

Table 17: Modbus Statistics

4.4.2 Device Settings

The device settings contain data to configure the device and the user interface. This registers are also accessible through the button interface in EDIT-mode for the system administrator. The data is stored persistently and will be preserved during power loss.

Register Name	Register Address	Bit Position															
		15	14	13	12	11	10	9	8	7	6	5	4	3	2	1	0
modbus_parameter	176 0x00B0	R [0]	R [0]	PAR [0x2]	modbus_baud [0x6]						device_addr [0x01]						
<p>This register contains the configuration for the Modbus port of the LSTAT device.</p> <p>PAR: defines the parity bit used for Modbus communication. Valid are: 0x0 – odd (odd parity bit, 1 stop bit) 0x1 – even (even parity bit, 1 stop bit) 0x2 – none (no parity bit, 2 stop bits)</p> <p>modbus_baud: defines the Modbus baudrate, following values are valid: 0x0 – 1200 0x1 – 2400 0x2 – 4800 0x3 – 9600 0x4 – 19200 0x5 – 38400 0x6 – 57600 0x7 – 115200</p> <p>device_addr: defines the Modbus slave address. Valid addresses are 1(0x01) to 247 (0xF7).</p> <p>① Compare Table 5 on Page 20 for device settings editable via the user interface.</p>																	

Table 18: Modbus Parameter

Register Name	Register Address	Bit Position															
		15	14	13	12	11	10	9	8	7	6	5	4	3	2	1	0
pincode_system_administrator	177 0x00B1	[0x0000]															
pincode_end_user	178 0x00B2	[0x0000]															
<p>pincode_system_administrator defines the pincode for the system administrator. If set to 0000 the pincode is disabled. Possible values are 0000 (0x0000) to 9999 (0x270F).</p> <p>pincode_end_user defines the pincode for the end user. If set to 0000 the pincode is disabled. Possible values are 0000 (0x0000) to 9999 (0x270F).</p> <p>① Compare Table 5 on Page 20 for device settings editable via the user interface.</p>																	

Table 19: Pincodes

Register Name	Register Address	Bit Position															
		15	14	13	12	11	10	9	8	7	6	5	4	3	2	1	0
lcd_color_red	179 0x00B3	reserved [0x00]								color_brightness [0x64]							
lcd_color_green	180 0x00B4	reserved [0x00]								color_brightness [0x64]							
lcd_color_blue	181 0x00B5	reserved [0x00]								color_brightness [0x64]							
lcd_brightness_contrast	182 0x00B6	lcd_contrast [0x64]								lcd_brightness [0x64]							
user_interface_settings	183 0x00B7	DAD [0x0]	GFV [1]	AF [1]	Time [1]	Date [0]	TF [1]	DAS [0]	R [0]	lcd_color_scheme [0x0]							

These registers are used to configure basic features of the display and the button interface.

color_brightness: defines the brightness of a specific backlight color. Values from 0x00 – 0% to 0x64 – 100% are valid.

lcd_brightness: defines the overall brightness of the LCD backlight. Values from 0x00 – 0% to 0x64 – 100% are valid.

lcd_contrast: defines the contrast setting of the LCD. Values from 0x00 – 0% to 0x64 – 100% are valid.

lcd_color_scheme: sets a predefined color setting, possible values are:

- 0x0 – user (as defined with the above values)
- 0x1 – white
- 0x2 – red
- 0x3 – green
- 0x4 – blue
- 0x5 – orange
- 0x6 – magenta
- 0x7 – cyan

DAS: display auto shuffle mode (0 – off, 1 – on), display values and set points will be shuffled after a defined timeout of 1 minute, each value is shown for 5 seconds

TF: time format (0 – 12h, 1 – 24h), if TF is set to 12h the date format will also be set to MM/DD instead of DD/MM

Date: show date in secondary display (0 – off, 1 – on)

Time: show time in secondary display (0 – off, 1 – on)

AF: acoustic feedback for touch buttons (0 – off, 1 – on)

GFV: goto first value after a defined timeout of 1 minute (0 – off, 1 – on)

DAD: display auto dim, dim display brightness after 2 minutes to following defined values:

- 0x0 – off (disabled)
- 0x1 – 50% lcd_brightness
- 0x2 – 10% lcd_brightness
- 0x3 – 0% lcd_brightness
- 0x4 – 0% lcd_brightness (depending on occupancy sensor *)

* As long as occupancy is detected the LCD brightness will stay at 100%. After 2 minutes without any occupancy detected it will be dimmed to 0%.

Register Name	Register Address	Bit Position
① Compare Table 5 on Page 20 for device settings editable via the user interface.		

Table 20: User Interface Settings

Register Name	Register Address	Bit Position															
		15	14	13	12	11	10	9	8	7	6	5	4	3	2	1	0
occupancy_sensor_config	184 0x00B8	EN [1]	R [0]	R [0]	R [0]	R [0]	R [0]	R [0]	R [0]	occupancy_timeout [0x0A]							
<p>With this register the function of occupancy sensor is enabled and controlled.</p> <p>occupancy_timeout: defines a timeout in seconds when the state of the occupancy flag of the short pressed register at address 1 will be cleared again after motion was detected. Anyway the occupancy flag of the present state register at address 0 will show the actual state of the occupancy sensor without occupancy timeout. Please see Figure 9 for further information on operation.</p> <p>EN: occupancy sensor enabled, only if enabled the occupancy flag of the present state and short pressed register at address 0 and 1, Table 7 on Page 26 will be set.</p> <p>① Applies only to LSTAT-801-Gx-Lx and LSTAT-802-Gx-Lx.</p>																	

Table 21: Occupancy Sensor Configuration

As depicted in Figure 9 the occupancy flag is set when motion is detected and will be cleared again after the occupancy_timeout has exceeded as defined at the occupancy_sensor_configuration register.

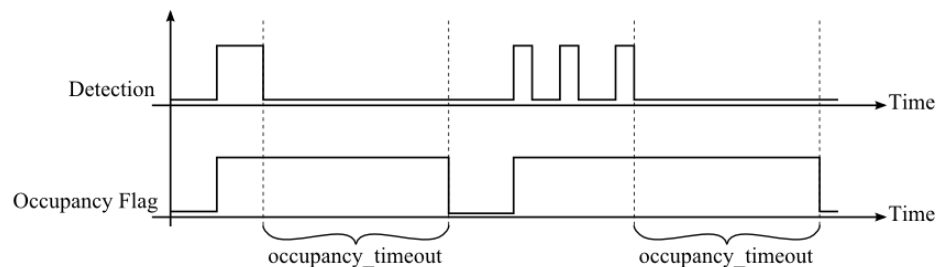

Figure 9: Occupancy Sensor Operation

4.4.3 Configuration Registers

The configuration registers contain data for configuring fundamental functions of the device as well as configurations for display values and set points. The data is stored persistent and will be preserved after reboot.

Register Name	Register Address	Bit Position															
		15	14	13	12	11	10	9	8	7	6	5	4	3	2	1	0
config_flags	192 0x00C0	R	SDSV	MSC	IRCP	DU	MU	VIE	VOL	AIE	AOL	PESA	PEEU	SDE	RST	[0]	[0]
<p>RST: reset_device flag, set to '1' the device will reboot</p> <p>SDE: secondary_display_direct_access_enabled flag, set to '1' the device displays the content of the secondary_display_direct_access_string register at address 200 (see Table 23 on Page 37)</p> <p>PEEU: pincode_enabled_for_end_user flag, if set to '1' the pincode for the end user can be edited by the end user</p> <p>PESA: pincode_enabled_for_system_administrator flag, if set to '1' the pincode for the end user and the system administrator can be edited by the system administrator</p> <p>AOL: acoustic_alarm_when_offline flag, if set to '1' a buzzer tone will be generated while the device is offline</p> <p>AIE: acoustic_alarm_on_internal_error flag, if set to '1' a buzzer tone will be generated if an internal error occurred</p> <p>VOL: visual_alarm_when_offline flag, if set to '1' the offline text symbol (OFFLINE) will be displayed while the device is offline</p> <p>VIE: visual_alarm_on_internal_error flag, if set to '1' the alarm symbol (△) will be displayed if an internal error occurred</p> <p>MU: modbus_unit, defines which unit system is used for values on Modbus. The following values are possible: 0x0 – K 0x1 – °C (SI) 0x2 – °F (US)</p> <p>DU: display_unit, defines which unit system is used to display values on the L-STAT. The following values are possible: 0x0 – access prohibited via the user interface 0x1 – °C (SI) 0x2 – °F (US)</p> <p>The display_unit can also be changed via the user interface in the device settings (see Table 5 an Page 20). If the value is set to '00' the access to this device setting via the user interface is prohibited.</p> <p>IRCP: ir_remote_control_pairing flag, for further information see Section 6.2</p> <p>MSC: modbus_statistics_clear flag, for further information see Table 17 on Page 32</p> <p>SDSV: secondary_display_direct_access_string_volatile flag, if set to '1' the content of secondary_display_direct_access_string (Table 23 on Page 37) is not kept persistent. This should be considered when the content of this register is changed frequently because of the limited write cycles of persistent memory.</p>																	

Table 22: Configuration Flags

Please note that a change of `display_unit` or `modbus_unit` at the `config_flags` register will change the configuration registers for display values at address 256 to 289 and set points at address 320 to 351 to match the selected units system. Please see Table 28 on Page 42 for display value configuration and Table 29 on Page 44 for set point configuration.

If the direct value registers at addresses 104 and 105 (see Table 15 on Page 31) are used to display certain values there is no need to set the SDE flag at the `config_flags` register (see Table 22 on Page 36) to show a text along with the value. If the direct value enable bit is set to '1' the content of `sec_display_direct_access_string` will be checked by the device. If the string is empty time and/or date will be displayed if enabled at `user_interface_settings` at address 183 (Table 20 on Page 35). Otherwise the content of the string will be displayed automatically. If it is desired to don't show anything at the secondary display a space character (0x20) needs to be inserted.

Register Name	Register Address	Bit Position															
		15	14	13	12	11	10	9	8	7	6	5	4	3	2	1	0
<code>secondary_display_direct_access_string</code>	200 0x00C8 – 207 0x00CF	<code>sec_display_direct_access_string</code>															
<p>The string will be displayed with the 4x16 segment digits of the secondary display. </p> <p>The string will be updated if the <code>secondary_display_direct_access_enabled</code> flag at the <code>config_flags</code> register at address 192 (Table 22 at Page 36) is set.</p> <p>① Up to 16 ASCII character (limited to characters from 0x20 to 0x5F) can be displayed. A string terminator (0x00) will determine the length of the string. If a string is longer than 4 characters the secondary display will work as a ticker.</p>																	

Table 23: Secondary Display Direct Access String

Register Name	Register Address	Bit Position															
		15	14	13	12	11	10	9	8	7	6	5	4	3	2	1	0
config_touch_button_0	208 0x00D0	DA [1]	ED [0]	EU [1]	DAD [0]	DAU [1]	MF [0]	R [0]	EN [1]	set_point_index [0x00]							
config_touch_button_1	209 0x00D1	DA [1]	ED [0]	EU [1]	DAD [0]	DAU [1]	MF [0]	R [0]	EN [1]	set_point_index [0x01]							
config_touch_button_2	210 0x00D2	DA [0]	ED [0]	EU [0]	DAD [0]	DAU [0]	MF [0]	R [0]	EN [1]	set_point_index [0x00]							
config_touch_button_3	211 0x00D3	DA [0]	ED [0]	EU [0]	DAD [0]	DAU [0]	MF [1]	R [0]	EN [1]	set_point_index [0x00]							
config_touch_button_4	212 0x00D4	DA [1]	ED [1]	EU [0]	DAD [1]	DAU [0]	MF [0]	R [0]	EN [1]	set_point_index [0x00]							
config_touch_button_5	213 0x00D5	DA [1]	ED [1]	EU [0]	DAD [1]	DAU [0]	MF [0]	R [0]	EN [1]	set_point_index [0x01]							
config_touch_button_6	214 0x00D6	DA [0]	ED [0]	EU [0]	DAD [0]	DAU [0]	MF [0]	R [0]	EN [1]	set_point_index [0x00]							
config_touch_button_7	215 0x00D7	DA [0]	ED [0]	EU [0]	DAD [0]	DAU [0]	MF [0]	R [0]	EN [1]	set_point_index [0x00]							

With these registers the functionality of the touch buttons is defined.

set_point_index: defines a set point register that can be edited in DIRECT_ACCESS-mode if the DA bit is set

EN: if set to '1' the defined button is enabled and its state will be updated in the present state, short pressed and long pressed register at Table 7 on Page 26

MF: if set to '1' the button is defined as MENU-button

DAU: if set to '1' the button is defined as UP-button in DIRECT_ACCESS-mode

DAD: if set to '1' the button is defined as DOWN-button in DIRECT_ACCESS-mode

EU: if set to '1' the button is defined as UP-button in EDIT-mode

ED: if set to '1' the button is defined as DOWN-button in EDIT-mode

DA: if set to '1' and the button gets pressed a set point defined by the set_point_index will be displayed in DIRECT_ACCESS-mode

① See Table 26 on Page 40 for example configurations.

Table 24: Touch Button Configuration

Register Name	Register Address	Bit Position															
		15	14	13	12	11	10	9	8	7	6	5	4	3	2	1	0
config_external_button_0	224 0x00E0	DA [0]	ED [0]	EU [0]	DAD [0]	DAU [0]	MF [0]	R [0]	EN [1]	set_point_index [0x00]							
config_external_button_1	225 0x00E1	DA [0]	ED [0]	EU [0]	DAD [0]	DAU [0]	MF [0]	R [0]	EN [1]	set_point_index [0x00]							
config_external_button_2	226 0x00E2	DA [0]	ED [0]	EU [0]	DAD [0]	DAU [0]	MF [0]	R [0]	EN [1]	set_point_index [0x00]							
config_external_button_3	227 0x00E3	DA [0]	ED [0]	EU [0]	DAD [0]	DAU [0]	MF [0]	R [0]	EN [1]	set_point_index [0x00]							
<p>With these registers the functionality of the external buttons is defined.</p> <p>set_point_index: defines a set point register that can be edited in DIRECT_ACCESS-mode if the DA bit is set</p> <p>EN: if set to '1' the defined button is enabled and its state will be updated in the present state, short pressed and long pressed register at Table 7 on Page 26</p> <p>MF: if set to '1' the button is defined as MENU-button</p> <p>DAU: if set to '1' the button is defined as UP-button in DIRECT_ACCESS-mode</p> <p>DAD: if set to '1' the button is defined as DOWN-button in DIRECT_ACCESS-mode</p> <p>EU: if set to '1' the button is defined as UP-button in EDIT-mode</p> <p>ED: if set to '1' the button is defined as DOWN-button in EDIT-mode</p> <p>DA: if set to '1' and the button gets pressed a set point defined by the set_point_index will be displayed in DIRECT_ACCESS-mode</p> <p>① See Table 26 on Page 40 for example configurations.</p>																	

Table 25: External Button Configuration

Description	Bit Position															
	15	14	13	12	11	10	9	8	7	6	5	4	3	2	1	0
no special function	0	0	0	0	0	0	0	1	0							
↪ The button is enabled but has no special function (e.g. OCCUPANCY-button). The set point index has no influence in this case.																
MENU-button	0	0	0	0	0	1	0	1	0							
↪ This combination can be used to determine the MENU-button. The set point index has no influence in this case.																
UP-button	0	0	1	0	1	0	0	1	0							
↪ This button will increment a set point in EDIT- or DIRECT_ACCESS-mode when pressed. The set point index has no influence in this case.																
DOWN-button with direct access	1	1	0	1	0	0	0	1	0							
↪ This button will decrement a set point in EDIT- or DIRECT_ACCESS-mode when pressed. Additionally a setpoint defined with the set_point_index is displayed when pressed and can be edited in DIRECT_ACCESS-mode.																

Table 26: Button Example Configuration

Register Name	Register Address	Bit Position															
		15	14	13	12	11	10	9	8	7	6	5	4	3	2	1	0
config_bar_graph_left	240 0x00F0	R [0]	R [0]	R [0]	R [0]	R [0]	R [0]	R [0]	EN [0]	set_point_index [0x00]							
config_bar_graph_right	241 0x00F1	R [0]	R [0]	R [0]	R [0]	R [0]	R [0]	R [0]	EN [1]	set_point_index [0x01]							
<p>These registers are used to associate a set point as source for the bar graph on the left and on the right side of the LCD. If enabled the bar graph is updated corresponding to the value of the set point defined with the set_point_index.</p> <p>The bar graph segments can also be set manually by writing the symbol_direct_access registers at address 99 and 100 (Table 12 on Page 29).</p> <p>set_point_index: defines a set point register that is used as source for the bar graph</p> <p>EN: if set to '1' the corresponding bar-graph will be updated to visualize the value of a set point with the defined set_point_index</p>																	

Table 27: Bar Graph Configuration

Register Name	Register Address	Bit Position																
		15	14	13	12	11	10	9	8	7	6	5	4	3	2	1	0	
config_display_value_0	256 0x0100	unit_modbus [0x1]				unit_lstat [0x1]				CAL [1]	semantic_meaning [0x01]							
	257 0x0101	VSA [1]	VEU [1]	DSSA [1]	DSEU [1]													
config_display_value_1	258 0x0102	unit_modbus [0xA]				unit_lstat [0xA]				CAL [1]	semantic_meaning [0x04]							
	259 0x0103	VSA [1]	VEU [1]	DSSA [1]	DSEU [1]													
config_display_value_2	260 0x0104	unit_modbus [0x1]				unit_lstat [0x1]				CAL [1]	semantic_meaning [0x05]							
	261 0x0105	VSA [1]	VEU [1]	DSSA [1]	DSEU [1]													
config_display_value_3 *	262 0x0106	unit_modbus [0xB]				unit_lstat [0xB]				CAL [1]	semantic_meaning [0x07]							
	263 0x0107	VSA [1]	VEU [1]	DSSA [1]	DSEU [1]													
config_display_value_4	264 0x0108	unit_modbus [0x8]				unit_lstat [0x8]				CAL [1]	semantic_meaning [0x0E]							
	265 0x0109	VSA [1]	VEU [1]	DSSA [1]	DSEU [1]													
config_display_value_5	266 0x010A	unit_modbus [0x1]				unit_lstat [0x1]				CAL [1]	semantic_meaning [0x03]							
	267 0x010B	VSA [1]	VEU [1]	DSSA [1]	DSEU [1]													
config_display_value_6	268 0x010C	unit_modbus [0x0]				unit_lstat [0x0]				CAL [0]	semantic_meaning [0x00]							
	269 0x010D	VSA [0]	VEU [0]	DSSA [0]	DSEU [0]													
config_display_value_7	270 0x010E	unit_modbus [0x0]				unit_lstat [0x0]				CAL [0]	semantic_meaning [0x00]							
	271 0x010F	VSA [0]	VEU [0]	DSSA [0]	DSEU [0]													
config_display_value_8	272 0x0110	unit_modbus [0x0]				unit_lstat [0x0]				CAL [0]	semantic_meaning [0x00]							
	273 0x0111	VSA [0]	VEU [0]	DSSA [0]	DSEU [0]													
config_display_value_9	274 0x0112	unit_modbus [0x0]				unit_lstat [0x0]				CAL [0]	semantic_meaning [0x00]							
	275 0x0113	VSA [0]	VEU [0]	DSSA [0]	DSEU [0]													
config_display_value_10	276 0x0114	unit_modbus [0x0]				unit_lstat [0x0]				CAL [0]	semantic_meaning [0x00]							
	277 0x0115	VSA [0]	VEU [0]	DSSA [0]	DSEU [0]													
config_display_value_11	278 0x0116	unit_modbus [0x0]				unit_lstat [0x0]				CAL [0]	semantic_meaning [0x00]							
	279 0x0117	VSA [0]	VEU [0]	DSSA [0]	DSEU [0]													
config_display_value_12	280 0x0118	unit_modbus [0x0]				unit_lstat [0x0]				CAL [0]	semantic_meaning [0x00]							
	281 0x0119	VSA [0]	VEU [0]	DSSA [0]	DSEU [0]													

Register Name	Register Address	Bit Position															
		unit_modbus [0x0]				unit_lstat [0x0]				CAL [0]	semantic_meaning [0x00]						
config_display_value_13	282 0x011A																
	283 0x011B	VSA [0]	VEU [0]	DSSA [0]	DSEU [0]												
config_display_value_14	284 0x011C																
	285 0x011D	VSA [0]	VEU [0]	DSSA [0]	DSEU [0]												
config_display_value_15	286 0x011E																
	287 0x011F	VSA [0]	VEU [0]	DSSA [0]	DSEU [0]												

These registers hold the configuration of the 16 display values.

semantic_meaning: is used to provide information about the semantic meaning and the source of the value. For further information please see Table 30 on Page 45.

CAL: if set to '1' the corresponding offset_value can be edited in CALIBRATION-mode (only capable if DSEU or DSSA is set to '1')

unit_lstat: defines a unit with which the corresponding display value appears on the LCD

unit_modbus: defines a unit that the corresponding display value register appears on Modbus

① For both, unit_lstat and unit_modbus the following values are possible:

0x0	0x1	0x2	0x3	0x4	0x5	0x6	0x7	0x8	0x9	0xA	0xB	0xC
no unit	°C	°F	cfm	l/s	m³/h	Pa	inWC	V	%	%RH	ppm	°F dec.

Bits 0-11 of the higher address of each configuration register indicate the symbols that are displayed along with the corresponding display value.

DSEU: display source for end user

DSSA: display source for system administrator

These two bits define if the value displayed is taken from a display_value register at address 64 to 79 (see Table 11 on Page 28) or from a sensor_value register at address 48 to 56 (see Table 10 on Page 27). The following states are valid:

0 – defines that the value is taken from a display_value register that has to be set via modbus

1 – defines that the value is taken from a sensor_value (+ offset_value) register that is

VEU: visible for end user

VSA: visible for system administrator

automatically updated with the current sensor value

These two bits define if the display value is visible for the end user and/or the system administrator. If set to '1' the value will be visible.

① See Table 31 on Page 46 for example configurations of display values or set points.

* Please note that config_display_value_3 register is only configured as above per default for LSTAT-802-Gx-Lx devices for displaying the actual CO₂ level. Otherwise all bits of this register are set to '0'.

Table 28: Display Value Configuration

Register Name	Register Address	Bit Position															
		15	14	13	12	11	10	9	8	7	6	5	4	3	2	1	0
config_set_point_0	320 0x0140	unit_modbus [0x1]				unit_lstat [0x1]				PIN [0]	semantic_meaning [0x01]						
	321 0x0141	VSA [1]	VEU [1]	ESA [1]	EEU [1]												
config_set_point_1	322 0x0142	unit_modbus [0x0]				unit_lstat [0x0]				PIN [0]	semantic_meaning [0x0B]						
	323 0x0143	VSA [1]	VEU [1]	ESA [1]	EEU [1]												
config_set_point_2	324 0x0144	unit_modbus [0x0]				unit_lstat [0x0]				PIN [0]	semantic_meaning [0x00]						
	325 0x0145	VSA [0]	VEU [0]	ESA [0]	EEU [0]												
config_set_point_3	326 0x0146	unit_modbus [0x0]				unit_lstat [0x0]				PIN [0]	semantic_meaning [0x00]						
	327 0x0147	VSA [0]	VEU [0]	ESA [0]	EEU [0]												
config_set_point_4	328 0x0148	unit_modbus [0x0]				unit_lstat [0x0]				PIN [0]	semantic_meaning [0x00]						
	329 0x0149	VSA [0]	VEU [0]	ESA [0]	EEU [0]												
config_set_point_5	330 0x014A	unit_modbus [0x0]				unit_lstat [0x0]				PIN [0]	semantic_meaning [0x00]						
	331 0x014B	VSA [0]	VEU [0]	ESA [0]	EEU [0]												
config_set_point_6	332 0x014C	unit_modbus [0x0]				unit_lstat [0x0]				PIN [0]	semantic_meaning [0x00]						
	333 0x014D	VSA [0]	VEU [0]	ESA [0]	EEU [0]												
config_set_point_7	334 0x014E	unit_modbus [0x0]				unit_lstat [0x0]				PIN [0]	semantic_meaning [0x00]						
	335 0x014F	VSA [0]	VEU [0]	ESA [0]	EEU [0]												
config_set_point_8	336 0x0150	unit_modbus [0x0]				unit_lstat [0x0]				PIN [0]	semantic_meaning [0x00]						
	337 0x0151	VSA [0]	VEU [0]	ESA [0]	EEU [0]												
config_set_point_9	338 0x0152	unit_modbus [0x0]				unit_lstat [0x0]				PIN [0]	semantic_meaning [0x00]						
	339 0x0153	VSA [0]	VEU [0]	ESA [0]	EEU [0]												
config_set_point_10	340 0x0154	unit_modbus [0x0]				unit_lstat [0x0]				PIN [0]	semantic_meaning [0x00]						
	341 0x0155	VSA [0]	VEU [0]	ESA [0]	EEU [0]												
config_set_point_11	342 0x0156	unit_modbus [0x0]				unit_lstat [0x0]				PIN [0]	semantic_meaning [0x00]						
	343 0x0157	VSA [0]	VEU [0]	ESA [0]	EEU [0]												
config_set_point_12	344 0x0158	unit_modbus [0x0]				unit_lstat [0x0]				PIN [0]	semantic_meaning [0x00]						
	345 0x0159	VSA [0]	VEU [0]	ESA [0]	EEU [0]												

Register Name	Register Address	Bit Position													
		unit_modbus [0x0]				unit_lstat [0x0]				PIN [0]	semantic_meaning [0x00]				
config_set_point_13	346 0x015A														
	347 0x015B	VSA [0]	VEU [0]	ESA [0]	EEU [0]										
config_set_point_14	348 0x015C														
	349 0x015D	VSA [0]	VEU [0]	ESA [0]	EEU [0]										
config_set_point_15	350 0x015E														
	351 0x015F	VSA [0]	VEU [0]	ESA [0]	EEU [0]										

These registers hold the configuration for the 16 set point.

semantic_meaning: is used to provide information about the semantic meaning of the set point. For further information please see Table 30 on Page 45.

PIN: if set to '1' the the corresponding set point is pincode protected and can only be changed in EDIT-mode if the correct pincode has been entered before.

unit_lstat: defines a unit with which the corresponding set point appears on the LCD

unit_modbus: defines a unit that the corresponding set point register appears on Modbus

① For both, unit_lstat and unit_modbus the following values are possible:

0x0	0x1	0x2	0x3	0x4	0x5	0x6	0x7	0x8	0x9	0xA	0xB	0xC
no unit	°C	°F	cfm	l/s	m ³ /h	Pa	inWC	V	%	%RH	ppm	°F dec.

Bits 0-11 of the higher address of each configuration register indicate the symbols that are displayed along with the corresponding display value.

EEU: editable for end user

ESA: editable for system administrator

These two bits define if the set point is editable for the end user and/or the system administrator. The following states are valid:

0 – defines that the set point is not editable

1 – defines that the set point is editable

VEU: visible for end user

VSA: visible for system administrator

These two bits define if the set point is visible for the end user and/or the system administrator. If set to '1' the set point will be visible.

① See Table 31 on Page 46 for example configurations of display values or set points.

Table 29: Set Point Configuration

Table 30 below shows possible values for the semantic meaning used in the configuration for display values (Table 28 on Page 42) and set points (Table 29 on Page 44).

Primarily the semantic meaning field defines a text that is displayed along with a display value or a set point. Additionally for display values it defines the internal sensor_value that is displayed when the DSEU or DSSA bit is set. For examples on how to use the semantic meaning field in the configuration registers please see Table 31 on Page 46.

Semantic Meaning Value	Description	Secondary Display Text
0x00	None (unconfigured)	
0x01	Internal Temperature abs.	R O O M
0x02	Internal Temperature rel.	Δ S P T
0x03	External Temperature	O U T
0x04	Relative Humidity	H U M
0x05	Dew Point	D E W
0x06	Luminance (lx)	L U X
0x07	Amount CO ₂	C O 2
0x08	Differential Pressure	P R E S
0x09	Flow	F L O W
0x0A	Valve Position	V A L V
0x0B	Fan Stage	F A N
0x0C	Heat/Cool Stage	H & C
0x0D	Brightness (%)	B R %
0x0E	Supply Voltage	2 4 V
0x0F	CPU voltage	C P U
0x10	CPU temperature	C P U
0x11	Room ID	R O O M
0x12	Damper Position (%)	D A M P
0x13	Reheat (%)	H E A T
0x14	Discharge Temperature	D I S

Table 30: Semantic Meaning

Table 31 below shows some example configurations for display values and set points on the next two pages.

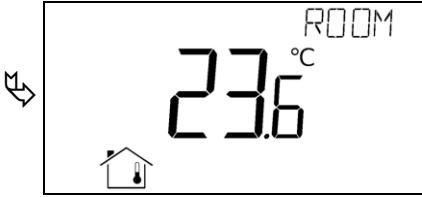
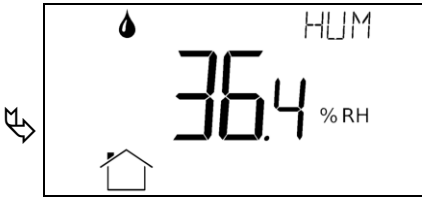
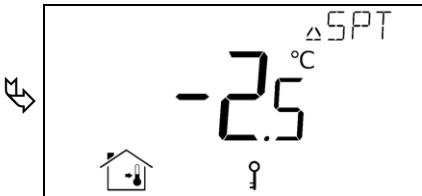
Description	Bit Position																
	15	14	13	12	11	10	9	8	7	6	5	4	3	2	1	0	
config_display_value_x internal temperature (from built in sensor)	0x1				0x1				1	0x01							
	1	1	1	1	0	0	0	0	0	0	0	0	0	0	1	0	
<p>The value of the built in temperature sensor will be displayed with the internal temperature symbol in °C. It will be visible for the end user and system administrator. See the following example for how the display would look like:</p> 																	
config_display_value_x relative humidity (value supplied over Modbus)	0xA				0xA				0	0x04							
	1	1	0	0	0	0	0	0	1	0	0	0	0	0	0	0	
<p>This is an example of a relative humidity display value. Because the DSEU and DSSA bit is set to '0' the content of the corresponding display_value_register will be displayed. It will be visible for the end user and system administrator. See the following example for how the display would look like:</p> 																	
config_set_point_x relative temperature	0x1				0x1				1	0x02							
	1	1	1	1	0	0	0	0	0	0	0	0	0	0	1	1	
<p>This is an example of a relative temperature set point in °C. The internal temperature symbol as well as the arrow symbol will be displayed. Since the set point is pincode protected also the key symbol will be displayed. See the following example for how the display would look like:</p> 																	
config_set_point_x	0x0				0x0				0	0x0B							

Description	Bit Position															
fan stage	1	1	1	1	0	0	0	0	0	0	1	0	0	0	0	0
<p>This is an example of a fan stage set point. The fan symbol and the actual stage will be displayed. The bar graph showing the actual stage of the fan is not displayed automatically but can be enabled via the corresponding bar graph configuration register at address 240-241 (see Table 27 on Page 40). See the following example for how the display would look like:</p>																
<div style="text-align: center;">  </div>																
<p>For a stage set point the following semantic meanings are possible:</p>																
<p>0x0A ... Valve Position</p>																
<p>0x0B ... Fan Stage</p>																
<p>0x0C ... Heat/Cool Stage</p>																
<p>The user can adjust the set point in manual mode within the limits defined by the set point max and min values (see Table 33 and Table 34). The automatic mode can be displayed by writing defined values to the specific set point register (see Table 32). The following values are possible:</p>																
<p>0x0000 ... Stage 0 Manual</p>																
<p>0x0001 ... Stage 1 Manual</p>																
<p>0x0002 ... Stage 2 Manual</p>																
<p>0x0003 ... Stage 3 Manual</p>																
<p>0x8000 ... Stage 0 Auto</p>																
<p>0x8001 ... Stage 1 Auto</p>																
<p>0x8002 ... Stage 2 Auto</p>																
<p>0x8003 ... Stage 3 Auto</p>																
<p>If the set point min value is set to any automatic stage the user will have the opportunity to switch between manual and automatic mode. In this case, if the set point max value is set to “Stage 3 Manual” for example, the user can select the following values:</p>																
<p>Stage 3 Manual</p>																
<p style="text-align: center;">⇕</p>																
<p>Stage 2 Manual</p>																
<p style="text-align: center;">⇕</p>																
<p>Stage 1 Manual</p>																
<p style="text-align: center;">⇕</p>																
<p>Stage 0 Manual</p>																
<p style="text-align: center;">⇕</p>																
<p>Stage 0 Auto</p>																

Table 31: Display Value and Set Point Example Configuration

Register Name	Register Address	Bit Position															
		15	14	13	12	11	10	9	8	7	6	5	4	3	2	1	0
set_point_0	384 0x0180	[0x00DC]															
set_point_1	385 0x0181	[0x0000]															
set_point_2	386 0x0182	[0x0000]															
set_point_3	387 0x0183	[0x0000]															
set_point_4	388 0x0184	[0x0000]															
set_point_5	389 0x0185	[0x0000]															
set_point_6	390 0x0186	[0x0000]															
set_point_7	391 0x0187	[0x0000]															
set_point_8	392 0x0188	[0x0000]															
set_point_9	393 0x0189	[0x0000]															
set_point_10	394 0x018A	[0x0000]															
set_point_11	395 0x018B	[0x0000]															
set_point_12	396 0x018C	[0x0000]															
set_point_13	397 0x018D	[0x0000]															
set_point_14	398 0x018E	[0x0000]															
set_point_15	399 0x018F	[0x0000]															
<p>These registers contain the values of up to 16 set points.</p> <p>All registers are 16 Bit signed values. Depending on the modbus_unit specified with the corresponding set point configuration register at address 320 to 351 (Table 29 at Page 44) the value needs to be scaled as described in Table 39 at Page 56 to achieve the desired result.</p>																	

Table 32: Set Points

Register Name	Register Address	Bit Position															
		15	14	13	12	11	10	9	8	7	6	5	4	3	2	1	0
set_point_max_0	416 0x01A0	[0x012C]															
set_point_max_1	417 0x01A1	[0x0003]															
set_point_max_2	418 0x01A2	[0x0000]															
set_point_max_3	419 0x01A3	[0x0000]															
set_point_max_4	420 0x01A4	[0x0000]															
set_point_max_5	421 0x01A5	[0x0000]															
set_point_max_6	422 0x01A6	[0x0000]															
set_point_max_7	423 0x01A7	[0x0000]															
set_point_max_8	424 0x01A8	[0x0000]															
set_point_max_9	425 0x01A9	[0x0000]															
set_point_max_10	426 0x01AA	[0x0000]															
set_point_max_11	427 0x01AB	[0x0000]															
set_point_max_12	428 0x01AC	[0x0000]															
set_point_max_13	429 0x01AD	[0x0000]															
set_point_max_14	430 0x01AE	[0x0000]															
set_point_max_15	431 0x01AF	[0x0000]															
		<p>These registers are used to allow set point changes for the end user or system administrator only within limits defined with a set_point_max value of this Table and a set_point_min value of Table 34.</p> <p>All registers are 16 Bit signed values. Depending on the modbus_unit specified with the corresponding set point configuration register at address 320 to 351 (Table 29 at Page 44) the value needs to be scaled as described in Table 39 at Page 56 to achieve the desired result.</p>															

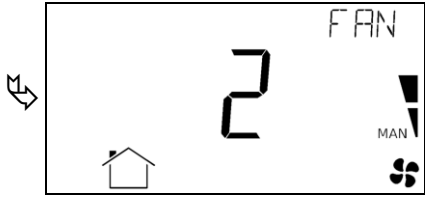
Table 33: Set Point max. Values

Register Name	Register Address	Bit Position															
		15	14	13	12	11	10	9	8	7	6	5	4	3	2	1	0
set_point_min_0	448 0x01C0	[0x0096]															
set_point_min_1	449 0x01C1	[0x0000]															
set_point_min_2	450 0x01C2	[0x0000]															
set_point_min_3	451 0x01C3	[0x0000]															
set_point_min_4	452 0x01C4	[0x0000]															
set_point_min_5	453 0x01C5	[0x0000]															
set_point_min_6	454 0x01C6	[0x0000]															
set_point_min_7	455 0x01C7	[0x0000]															
set_point_min_8	456 0x01C8	[0x0000]															
set_point_min_9	457 0x01C9	[0x0000]															
set_point_min_10	458 0x01CA	[0x0000]															
set_point_min_11	459 0x01CB	[0x0000]															
set_point_min_12	460 0x01CC	[0x0000]															
set_point_min_13	461 0x01CD	[0x0000]															
set_point_min_14	462 0x01CE	[0x0000]															
set_point_min_15	463 0x01CF	[0x0000]															
		<p>These registers are used to allow set point changes for the end user or system administrator only within limits defined with a set_point_max value of Table 33 and a set_point_min value of this Table.</p> <p>All registers are 16 Bit signed values. Depending on the modbus_unit specified with the corresponding set point configuration register at address 320 to 351 (Table 29 at Page 44) the value needs to be scaled as described in Table 39 at Page 56 to achieve the desired result.</p>															

Table 34: Set Point min. Values

Register Name	Register Address	Bit Position															
		15	14	13	12	11	10	9	8	7	6	5	4	3	2	1	0
offset_value_0	480 0x01E0	[0x0000]															
offset_value_1	481 0x01E1	[0x0000]															
offset_value_2	482 0x01E2	[0x0000]															
offset_value_3	483 0x01E3	[0x0000]															
offset_value_4	484 0x01E4	[0x0000]															
offset_value_5	485 0x01E5	[0x0000]															
offset_value_6	486 0x01E6	[0x0000]															
offset_value_7	487 0x01E7	[0x0000]															
offset_value_8	488 0x01E8	[0x0000]															
offset_value_9	489 0x01E9	[0x0000]															
offset_value_10	490 0x01EA	[0x0000]															
offset_value_11	491 0x01EB	[0x0000]															
offset_value_12	492 0x01EC	[0x0000]															
offset_value_13	493 0x01ED	[0x0000]															
offset_value_14	494 0x01EE	[0x0000]															
offset_value_15	495 0x01EF	[0x0000]															
		<p>These registers are used to define offsets for display values when displaying a value from a built in sensor. These registers can either be written via Modbus or can be edited in CALIBRATION-mode by the system administrator.</p> <p>All registers are 16 Bit signed values. Depending on the modbus_unit specified with the corresponding display value configuration register at address 256 to 287 (Table 28 at Page 42) the value needs to be scaled the same as the corresponding display value as described in Table 39 at Page 56.</p>															

Table 35: Offset Values

4.4.4 Model Information Registers (read only)

These registers are set at production time and contain specific information about the specific model and the default button print layout.

Register Name	Register Address	Buttonlayout LSTAT-80x-Gx-...	Default Value
default_print_ touch_button_0	528 0x0210	L1	[0x0004]
		L2	[0x0004]
		L3	[0x0004]
		L4	[0x0004]
		L5	[0x0004]
		L6	[0x0004]
default_print_ touch_button_1	529 0x0211	L1	[0x0000]
		L2	[0x0006]
		L3	[0x0006]
		L4	[0x000A]
		L5	[0x0006]
		L6	[0x0006]
default_print_ touch_button_2	530 0x0212	L1	[0x0000]
		L2	[0x0000]
		L3	[0x0008]
		L4	[0x0008]
		L5	[0x000A]
		L6	[0x000A]
default_print_ touch_button_3	531 0x0213	L1	[0x0001]
		L2	[0x0001]
		L3	[0x0001]
		L4	[0x0001]
		L5	[0x0001]
		L6	[0x0001]
default_print_ touch_button_4	532 0x0214	L1	[0x0005]
		L2	[0x0005]
		L3	[0x0005]
		L4	[0x0005]
		L5	[0x0005]
		L6	[0x0005]
default_print_ touch_button_5	533 0x0215	L1	[0x0000]
		L2	[0x0007]
		L3	[0x0007]
		L4	[0x000B]
		L5	[0x0007]
		L6	[0x0007]
default_print_ touch_button_6	534 0x0216	L1	[0x0000]
		L2	[0x0000]
		L3	[0x0009]
		L4	[0x0009]
		L5	[0x000B]
		L6	[0x000B]
default_print_ touch_button_7	535 0x0217	L1	[0x0002]
		L2	[0x0002]
		L3	[0x0002]
		L4	[0x0002]
		L5	[0x0002]
		L6	[0x0008]













Register Name	Register Address	Buttonlayout LSTAT-80x-Gx-...	Default Value
default_print_external_button_0	536 0x0218	applies to all types	[0x0000]
default_print_external_button_1	537 0x0219	applies to all types	[0x0000]
default_print_external_button_2	538 0x021A	applies to all types	[0x0000]
default_print_external_button_3	539 0x021B	applies to all types	[0x0000]
<p>Button Print Layout – describes which symbols are printed on the front panel and on the external buttons by default. The following symbols are defined:</p> <p>0x0000 – none </p> <p>0x0001 – menu </p> <p>0x0002 – occupancy </p> <p>0x0003 – reserved</p> <p>0x0004 – temp_up </p> <p>0x0005 – temp_down </p> <p>0x0006 – fan_up </p> <p>0x0007 – fan_down </p> <p>0x0008 – light_on </p> <p>0x0009 – light_off </p> <p>0x000A – blinds_up </p> <p>0x000B – blinds_down </p> <p>0x000C – light_up </p> <p>0x000D – light_down </p>			

Table 36: Model Information Registers

4.4.5 Device Information Registers (read only)

The registers shown in Table 37 are set at production and contain specific information about the device.

Description	Register Address	Bit Position															
		15	14	13	12	11	10	9	8	7	6	5	4	3	2	1	0
product_code_string	560 0x0230	product_code_string															
	– 569 0x0239																
serial_number_string	576 0x0240	serial_number_string															
	– 585 0x0249																
firmware_version_string	592 0x0250	firmware_version_string															
	– 595 0x0253																
firmware_date	596 0x0254	firmware_date_0															
	597 0x0255	firmware_date_1															
bootloader_version_string	608 0x0260	bootloader_version_string															
	– 611 0x0263																
bootloader_date	612 0x0264	bootloader_date_0															
	613 0x0265	bootloader_date_1															
		ⓘ firmware_date_0 and firmware_date_1 as well as bootloader_date_0 and bootloader_date_1 represent a 32 bit timestamp in seconds since JAN-01-1970 indicating the build time.															

Table 37: Device Information Registers

4.4.6 NFC Registers

These registers provide an URL that can be accessed by NFC enabled devices such as smart phones to get additional information and control of the room automation.

Description	Register Address	Bit Position															
		15	14	13	12	11	10	9	8	7	6	5	4	3	2	1	0
url_string	1024 0x0400 – 1148 0x047C	[http://www.loytec.com]															
		ⓘ Up to 248 ASCII character including a string terminator (0x00) can be used. The string will be converted to a NDEF URI record that is saved on the NFC tag. For further information on the NFC interface see Chapter 5.															

Table 38: NFC Registers

4.4.7 Value Scaling and Stepwidth

The following Table 39 gives an overview of how Modbus register datapoints (display values, set points, min., max. and offset values) need to be scaled to achieve the desired result at the L-STAT display. It also shows which stepwidth is defined for set points.

Physical Value	Unit	Modbus Scaling $A \cdot 10^B \cdot (\text{raw} + C)$			Set Point Stepwidth	Example	
		A	B	C		raw value	displayed value
No Unit	-	1	0	0	1	100	100.0
Temperature	(K)	1	-1	-2740	0,5	2975	023.5 °C
	°C	1	-1	0	0,5	235	023.5 °C
	°F	1	-1	0	1,0	743	074.0 °F
	°F dec.	1	-1	0	0,5	743	074.5 °F
Flow	m³/h	1	0	0	1	150	150.0 m³/h
	l/s	1	-1	0	0,1	417	041.7 l/s
	cfm	1	0	0	1	88	088.0 cfm
Pressure	Pa	1	0	0	1	200	200.0 Pa
	inWC	1	-3	0	0,01	803	0.803 inWC
Voltage	V	1	-1	0	0,1	240	024.0 V
Percentage	%	5	-3	0	1	9000	045.0 %
Humidity	%RH	5	-3	0	1	9000	045.0 %RH
Amount CO ₂	ppm	1	0	0	1	550	550.0 ppm
<p>Note that though a display value or a set point would accept values from 0 to 65535 if unsigned or -32768 to 32767 if signed the value that is displayed is limited to a range from -999 to 9999 because of the 4 digit display.</p> <p>① When a fixed-point number reaches a certain limit where an overflow occurs the decimal point is shifted rightwards (e.g. 999.9 → 1000).</p> <p>① Whole number values are preferably displayed with the bigger digits. If an overflow occurs the number is shifted rightwards (e.g. 999 → 1000).</p>							

Table 39: Value Scaling and Stepwidth

5 NFC

5.1 General Description

The NFC interface of the L-STAT device can be used to get additional information and configuration options for room automation. The L-STAT will behave like an NFC tag that can be read by an NFC enabled device. The antenna is located behind the LCD and best performance is achieved by putting the NFC enabled device right on the front panel glass. Depending on where the antenna of the mobile device is located the optimal position will be found by moving the device slowly over the front panel. Best performance can be achieved by positioning the device in a more or less horizontal position covering the LCD as shown in Figure 10.



Figure 10: NFC Device Positioning

If the connection is established the NFC field detection bit at the short_pressed Modbus register at address 1 (Table 7 at Page 26) will be set. In the meantime the NFC enabled device will read the memory of the tag and will perform an appropriate action. Since a NDEF URI record is saved at the tags memory (Table 38 at Page 55) the device will ask to open the defined URL in the browser of the NFC enabled device.

5.2 Copy the L-WEB Project URL to the NFC Tag Memory

To show an L-WEB project on your mobile device by NFC, simply copy and paste the URL of the L-Web project to the `url_string` of Table 38. Note that the mobile device needs network or internet access to open the URL. Please follow the instructions below.

To Copy a L-WEB Project URL to the NFC Tag Memory

1. Open the web interface of your device
2. Select **Project List** from the **L-WEB** menu.
3. Open the desired project in the web browser as shown in Figure 11.

The screenshot displays the 'L-WEB Project List' interface. At the top, there is a header with the LOYTEC logo and the title 'L-WEB Project List'. Below the header, there is a navigation sidebar on the left with options: Device Info, Data, Commission, Config, Statistics, L-WEB (selected), L-IOB, Documentation, Reset, Contact, and Logout. The main content area shows a table of available L-WEB projects. The table has three columns: Name, Last modified, and Size (Bytes). Each row represents a project and includes a small globe icon with a tooltip that says 'Open project in web browser (LWEB-802)'. The projects listed are:

Name	Last modified	Size (Bytes)
Istudio\System.VAVsystem_VAV01_AW_VAV01.VAVmanagerStatusArea.lweb2	09.10.2015 09:50:30	1201856
Istudio\System.VAVsystem_VAV01_AW_VAV01.VAVstatus.lweb2	09.10.2015 09:50:38	2607877
Istudio\System.VAVsystem_VAV01_AW_VAV01.VAVmobile.lweb2	09.10.2015 09:50:32	523488
Istudio\System.VAVsystem_VAV01_AW_VAV01.VAVmanagerStatusBuilding.lweb2	09.10.2015 09:50:31	1207042
Istudio\System.VAVsystem_VAV01_AW_VAV01.VAVmobileCalibration.lweb2	09.10.2015 09:50:33	281473
Istudio\System.VAVsystem_VAV01_AW_VAV01.VAVsimulation.lweb2	09.10.2015 09:50:33	593128
Istudio\System.VAVsystem_VAV01_AW_VAV01.VAVmanagerStatusFloor.lweb2	09.10.2015 09:50:31	1202361
Istudio\System.VAVsystem_VAV01_AW_VAV01.VAVsimulationCO2.lweb2	09.10.2015 09:50:33	236230

Figure 11: L-WEB Project List

4. Simply copy the URL of the desired project from the browser's address bar and go to the **Modbus Datapoints** of the L-STAT device.
5. Open the **nfc_string** datapoint in the web interface of your device and paste the L-WEB project URL at the **Value** field as shown in Figure 12.
6. Click on the **Set** button to save the string.

Data Point Details

Path	/Modbus Port RS485/Datapoints/L-STAT_80x-Lx-Gx_V18_1/nfc_string
Name	nfc_string
Description	NFC URL
Direction	value
Type	string

Value:

Enter "--" for invalid value

Raw value	68 74	74 70	3A 2F	2F 77
	77 77	2E 6C	6F 79	74 65
	63 2E	63 6F	6D 2F	6C 77
	65 62	38 30	32 2F	3F 70
	72 6F	6A 65	63 74	3D 6C
	73 74	75 64	69 6F	2F 53
	79 73	74 65	6D 2E	56 41
	56 73	79 73	74 65	6D 5F
	56 41	56 30	31 5F	41 57
	5F 56	41 56	30 31	2E 56
	41 56	6D 6F	62 69	6C 65
	2E 6C	77 65	62 32	26 61
	64 64	72 65	73 73	3D 31
	39 32	2E 31	36 38	2E 32
	2E 31	30 37	26 70	6F 72
	74 3D	38 30	23 6C	76 69
73 50	61 67	65 00		

Enter "--" for invalid value

Figure 12: L-STAT NFC String

6 IR-Remote Control Operation

6.1 General Description

The IR receiver is located behind the front panel glass above the LCD. The L-STAT device implements the NEC IR protocol compatible with the Apple remote control as displayed in Figure 13.

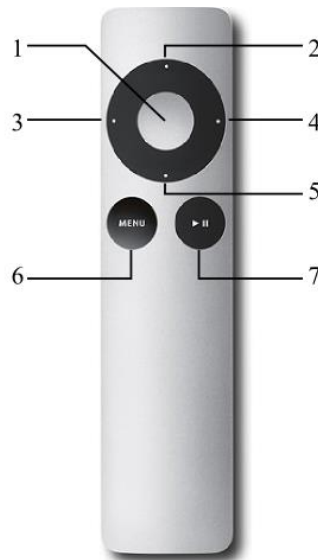

Figure 13: Apple Remote Control

Whenever a command gets received the IRC bit at the short_pressed Modbus register at address 1 (Table 7 at Page 26) is set. The received button code as well as the remote ID can be read from the ir_remote_control_command register at address 32 (Table 9 at Page 27).

Button Number	Description	Button Code
1	Center	46
2	Up	5
3	Left	4
4	Right	3
5	Down	6
6	Menu	1
7	Play/Pause	47

Table 40: Apple Remote Button Codes

6.2 Remote Control Pairing

Each remote control has an ID that is transmitted along with the button code. This ID can be used to pair a certain remote control with a certain L-STAT device. The ID of the Apple remote control can be changed by pressing Menu and Center button for at least 6s. This will increment the ID by one.

The ID of your remote control can be checked by pressing any button and watching the `ir_remote_control_command` register in the Web interface as shown in Figure 14 below. This example shows that the Menu button was pressed on a remote control with the ID 14.

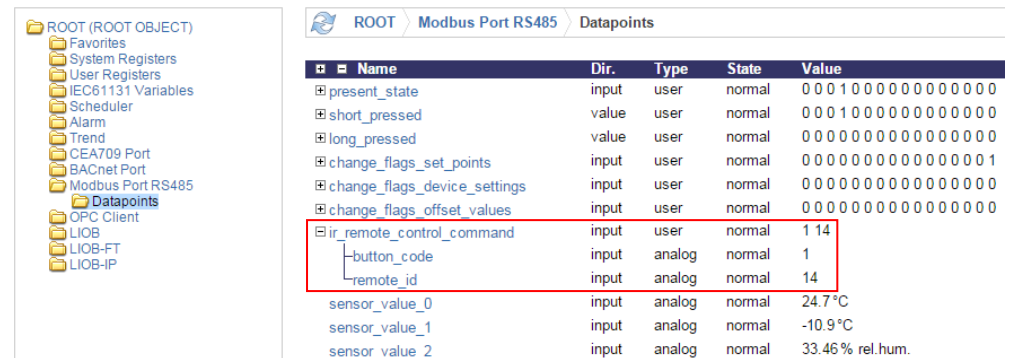

Name	Dir.	Type	State	Value
present_state	input	user	normal	000100000000000000
short_pressed	value	user	normal	000100000000000000
long_pressed	value	user	normal	000000000000000000
change_flags_set_points	input	user	normal	000000000000000001
change_flags_device_settings	input	user	normal	000000000000000000
change_flags_offset_values	input	user	normal	000000000000000000
ir_remote_control_command	input	user	normal	114
button_code	input	analog	normal	1
remote_id	input	analog	normal	14
sensor_value_0	input	analog	normal	24.7°C
sensor_value_1	input	analog	normal	-10.9°C
sensor_value_2	input	analog	normal	33.46% rel.hum.

Figure 14: IR Remote Control Command Register

If an L-STAT device gets paired with a certain remote control it will only update the `ir_remote_control_command` register and the IRC bit at the `short_pressed` register when receiving a command from this remote control.

Pairing can be achieved by pressing Menu and Right button at the remote control for at least 6s while pointing towards the L-STAT device. If pairing worked the secondary display will shortly show 'IRP' (IR pairing). The remote ID will be saved internally and the IRCP flag of the `config_flags` register at address 192 (Table 22 at Page 36) will be set.

The pairing can be canceled by either clearing the IRCP flag or by pressing Menu and Left button for at least 6s. If the secondary display shows 'IRUP' (IR unpairing) shortly the pairing is suspended.

7 Firmware Update

7.1 Firmware Update via the Web Interface

The current firmware can be downloaded from the Software Download section on the LOYTEC website: <https://www.loytec.com/support/download>

For the firmware update go to the web interface of the L-INX, L-ROC, L-IOB device.

To Update the Firmware via the Web Interface

1. Select **Modbus** under the **Commission** menu.
2. A listing of available devices will be displayed. Select the devices for the firmware update by clicking the check box on the right.
3. Select **Update firmware...** from the drop-down menu as shown in Figure 15 and click the **Select file...** button.

The screenshot shows the 'Modbus Commissioning' web interface. On the left, there is a navigation menu with 'Commission' selected, and 'Modbus' is highlighted under the 'Commission' section. The main area displays a table of devices in configuration. The table has columns for UID, Device, Status, Address, Port, Action on selected, and Firmware Version. A dropdown menu is open over the 'Action on selected' column, showing options: Decommission, Enable, Disable, and Update firmware... The 'Update firmware...' option is highlighted. A 'Select file...' button is visible next to the dropdown.

UID	Device	Status	Address	Port	Action on selected	Firmware Version
155E	L-STAT_80x-Gx-Lx_V12_1	OK	1	Modbus RS-485 (Master)	Enable Disable	1.1.1.0
1E7A	L-STAT_80x-Gx-Lx_V12_2	OK	2	Modbus RS-485 (Master)	Update firmware...	1.1.1.0
2796	L-STAT_80x-Gx-Lx_V12_3	OK	3	Modbus RS-485 (Master)	029901-4000BC427664	1.1.1.0

Figure 15: Web Interface – Modbus Commission

4. A File-Dialog window will pop up. Select the firmware file and click **Open**.
5. The selected devices will then receive the firmware updated.

7.2 Restoring Default Modbus Settings in Bootloader

If something went wrong during the firmware update the device keeps waiting in bootloader until a complete firmware image was received over Modbus. If also the Modbus settings got lost a procedure has been implemented in bootloader version 1.2.2 to restore the default Modbus settings: Parity = None, Baudrate = 57,6kB, Address = 1

To Restore the Default Modbus Settings in Bootloader

1. Unplug the power supply of the device.
2. Install a cable bridge between EB2 and EB3 as shown in Figure 16 below.



Figure 16: Cable Bridge EB2-EB3

3. Plug in the power supply again.
4. A red clock symbol will be displayed: ⌚
5. If the cable bridge between EB2 and EB3 gets removed within 10 seconds from now on, the default Modbus settings will be restored. Otherwise the device will try to boot up as usual after the timeout has expired.

8 Configuration Backup & Restore

8.1 Configuration Backup & Restore via the Web Interface

For further information on configuration backup and restore via the web interface please refer to the LOYTEC Device User Manual [2].

9 Troubleshooting

9.1 Technical Support

LOYTEC offers free telephone and e-mail support for the L-STAT product series. If none of the above descriptions solves your specific problem please contact us at the following address:

LOYTEC electronics GmbH
Blumengasse 35
A-1170 Vienna
Austria / Europe

e-mail : *support@loytec.com*
Web : *http://www.loytec.com*
tel : *+43/1/4020805-100*
fax : *+43/1/4020805-99*

or

LOYTEC Americas Inc.
N27 W23957 Paul Road
Suite 103
Pewaukee, WI 53072
USA

e-mail: *support@loytec-americas.com*
Web: *http://www.loytec-americas.com*
tel: *+1 (512) 402 5319*
fax: *+1 (262) 408 5238*

or

LOYTEC Asia Corporation Ltd.
16F.-3, No. 155, Zhongyang Rd
Xindian District
New Taipei City 23150
Taiwan

e-mail: *support-asia@loytec.com*
tel: *+886 (2) 8913 7838*
fax: *+886 (2) 8913 7830*

10 Specifications

10.1 Physical Specifications

Operating Voltage	24 VDC \pm 10 %
Power Consumption	see Table 41
In rush current	up to 4A @ 24 VDC
Operating Temperature (ambient)	0°C to +50°C
Storage Temperature	-10°C to +60°C
Humidity (non condensing) operating	10 to 90 % RH @ 50°C
Humidity (non condensing) storage	10 to 90 % RH @ 50°C
LCD Backlight Lifetime	50,000 hours
Enclosure	94.5 x 110 x 19.5 (W x H x D)
Environmental Protection	IP 30 (enclosure)
Installation	Europe: switch box \varnothing 60mm US: switch box 4" x 2"

LCD brightness	LSTAT-800-Gx-Lx & LSTAT-801-Gx-Lx	LSTAT-802-Gx-Lx
100%	0.8W	0.93W avg., 1.8W max.
0%	0.09W	0.22W avg., 1.1W max.

Table 41: Power Consumption

Following Table 42 should provide support for dimensioning of an installation and the power supply. For each device type there is a listing for up to 16 devices of the maximum possible cable length and the resulting power loss on the cable for different supply voltage levels. Together with the power consumption of the devices one can calculate the required power of the power supply.

Conditions of the Installation		Number of Devices																
		1	2	3	4	5	6	7	8	9	10	11	12	13	14	15	16	
L-STAT 800/801	maximum power consumption of devices [W]	0,8	1,6	2,4	3,2	4,0	4,8	5,6	6,4	7,2	8,0	8,8	9,6	10,4	11,2	12,0	12,8	
	max. Cable length [m]	for 0,5mm ²	1.620	810	540	400	320	270	230	200	180	160	140	130	120	110	100	100
		for 1,0mm ²	3.250	1.620	1.080	810	650	540	460	400	360	320	290	270	250	230	210	200
	max. Power loss on cable [W]	0,2	0,4	0,6	0,9	1,1	1,3	1,5	1,7	1,9	2,1	2,3	2,6	2,8	3,0	3,2	3,4	
	max. Cable length [m]	for 0,5mm ²	1.260	630	420	310	250	210	180	150	140	120	110	100	90	90	80	70
		for 1,0mm ²	2.530	1.260	840	630	500	420	360	310	280	250	230	210	190	180	160	150
max. Power loss on cable [W]	0,3	0,5	0,8	1,0	1,3	1,6	1,8	2,0	2,3	2,6	2,9	3,1	3,3	3,6	3,7	3,8		
L-STAT 802	maximum power consumption of devices [W]	1,8	3,6	5,4	7,2	9,0	10,8	12,6	14,4	16,2	18,0	19,8	21,6	23,4	25,2	27,0	28,8	
	max. Cable length [m]	for 0,5mm ²	720	360	240	180	140	120	100	90	80	70	60	60	50	50	40	40
		for 1,0mm ²	1.440	720	480	360	280	240	200	180	160	140	130	120	110	100	90	90
	max. Power loss on cable [W]	0,5	1,0	1,5	1,9	2,3	2,9	3,3	3,9	4,4	4,7	5,3	5,8	6,3	6,5	6,6	7,8	
	max. Cable length [m]	for 0,5mm ²	560	280	180	140	110	90	80	70	60	50	50	40	40	40	30	30
		for 1,0mm ²	1.120	560	370	280	220	180	160	140	120	110	100	90	80	80	70	70
max. Power loss on cable [W]	0,6	1,2	1,7	2,3	2,8	3,3	4,1	4,7	5,0	5,7	6,3	6,6	6,7	8,2	7,9	9,4		

Table 42: Cable Length and Power Loss on Cable

Infrared Receiver

protocol: NEC
carrier: 38 kHz @ 950 nm
Apple remote control compatible

11 References

- [1] L-INX Configurator User Manual, LOYTEC electronics GmbH
- [2] LOYTEC Device User Manual, LOYTEC electronics GmbH

12 Revision History

Date	Version	Author	Description
2015-12-09	1.0	HG	Initial Manual Version
2016-02-25	1.1	HG	Added comment for cleaning mode at MENU-Button description, revised description of 3.2.2 Operating Modes, extended description at 4.1 Introduction, revised Figure 7, changed size of Figure 8, changed layout of Table 36, added Table 42 and description for cable length and power supply dimensioning, extended description of CO ₂ sensor self calibration algorithmus, correction of typing errors
2016-05-25	1.2	HG	“What’s new” Chapter added, “Configuration Backup & Restore” Chapter added, Minor mistakes corrected, description for temperature sensor on EB3 added at Section 3.1, Table 4 reworked, Figure 5 and description added Section 3.2.3, description for external temperature sensor added below Table 10, Table 12, Table 13 and Table 20 reworked, occupancy_timeout description corrected at Table 21, SDSV flag added and descriptions revised at Table 22, descriptions added at Section 4.4.3, Table 23 info text reworked, pictures added at Table 36, description for Table 39 modified, updated Figure 15
2016-10-31	1.3	HG	Description at DIRECT_ACCESS-mode added at Table 4, Display Auto Shuffle added at Table 5, description of Table 7 modified, change flag for display_unit added at Table 8, DAS flag and description added at Table 20, “°F dec.” unit added at Table 28 and Table 29, text modified at Page 45, example configuration for fan stage set point added at Table 31, light_up and light_down default print added at Table 36, “°F dec.” unit added at Table 39, added Section 7.2
2017-01-18	1.4	HG	Description for new feature (loading factory default values) added at Section 3.2.4 and 3.2.5